

REV.	DESCRIPTION	DRAWN	DATE
1	INITIAL RELEASE	Willis	2012/08/03
2	new frame, corrected actuator form dims, removed page 2 dim. table, add "how to order" notes	Fros	2017/09/20

**SPECIFICATION:**

1. ELECTRICAL
  - 1.1 Current Rating: 0.5A per pin
  - 1.2 Voltage Rating: 50V DC/AC
  - 1.3 Contact Resistance: 20mΩ
  - 1.4 Insulation Resistance: 50MΩ
  - 1.5 Dielectric Withstanding Voltage: 250VAC
2. MECHANICAL
  - 2.1 Durability: 20 Cycle
  - 2.2 FPC Retention Force: 0.3N per pin min.
3. ENVIRONMENTAL
  - 3.1 Operating temperature range: -40°C~+85°C
  - 3.2 Storage temperature range: -40°C~+85°C
4. SOLDER ABILITY
  - 4.1 Recommended IR-Reflow Temperature: 260°C

**How to order:**

311A- XX U A A - R  
 1 2 3 4

- △ 1 pin count: xx= 04~68  
 (Please contact with sales for the pins count available)
- 2 contact type: U= upper contact
- 3 plating: A= Tin plating under Nickel
- 4 packing: A= tape and reel

4	HOLDDOWN	Brass, 100u" Tin over 50u" Nickel plating
3	CONTACT	Phosphor Bronze, 100u" Tin over 50u" Ni plating
2	ACTUATOR	PPS UL94V-0
1	HOUSING	PA-46 UL94V-0

NO.		PART NAME	DESCRIPTION
UNLESS OTHERWISE SPECIFIED TOLERANCE			
UNIT:	DECIMAL	LINEAR	ANGLES
	mm	X, ±0.50	±5°
		X.X, ±0.25	±3°
	X.XX, ±0.12		±1°
DRAWN		Willis	2012/08/03
CHECKED		Angel	2012/08/03
APPROVED		Ken	2012/08/03
SCALE		SHEET	SIZE
4/1	1/1		A4
DRAWN NAME:		FPC Connector, Pitch 0.5, H2.0 Upper Contact Type	
PRODUCT NO.		see how to order	
FILE NAME		311A-XXUAA-R_B_2	

**RECOMMENDED LAYOUT (TOP VIEW)**  
**GENERAL TOLERANCE: ±0.05mm**

**FPC DIMENSION**  
**THICKNESS 0.30mm**



www.attend.com.tw

03 PIN-20 PIN

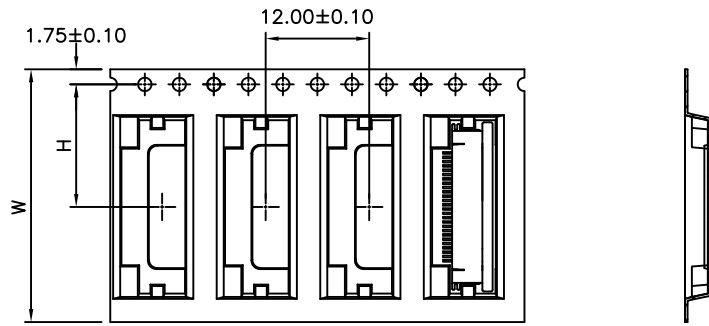

1. 10 sprocket hole pitch cumulative tolerance  $\pm 0.20$ .
2. Carrier camber is within 1 mm in 250mm.
3. Material : Black Conductive Polystyrene Alloy (UP-6100).
4. All dimensions meet EIA-481-B requirements.
5. Thickness :  $0.35 \pm 0.05$ mm.
6. Packing length per 22" reel : 75.0 Meters.
7. Components load per 13" reel : 2000 pcs.

21 PIN-60 PIN

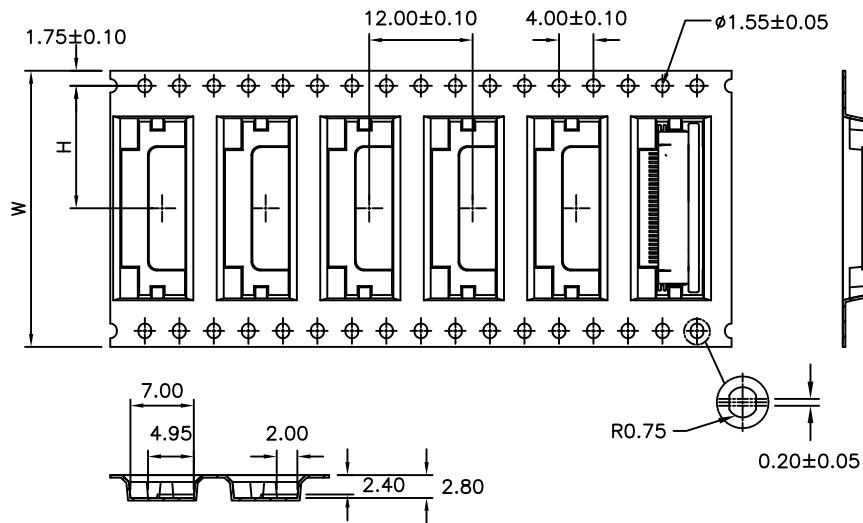

USER DIRECTION OF FEED  $\rightarrow$

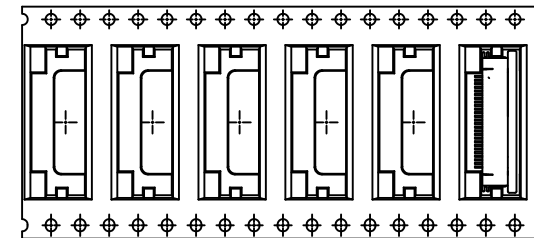

PIN= XX	03 — 04	05 — 20	21 — 30	31 — 50	51 — 60
W $\pm 0.30$	16.00	24.00	32.00	44.00	56.50
H $\pm 0.10$	7.50	11.50	14.20	20.20	26.20

UNLESS OTHERWISE SPECIFIED TOLERANCE		
ANGLES	ANG.	$\pm 5^\circ$
	0.	$\pm 0.3$
LINEAR	0.0	$\pm 0.25$
	0.00	$\pm 0.20$
SCALE	AS SHOWN	UNIT: mm
DRAWN	Willis	2012/08/03
CHECKED	Angel	2012/08/03
APPROVED	Ken	2012/08/03
SIZE	A4	REV. 1.0



**ATTEND**

[www.attend.com.tw](http://www.attend.com.tw)

DRAWN NAME:  
FPC Connector Pitch:0.5mm H:2.0mm  
Packaging drawing

PRODUCT NO. 311A-XXXAA-R

FILE NAME 311A-XXXAA-R\_D\_1

REV.	DESCRIPTION	DATE	REV.	DESCRIPTION	DATE
1			4		
2			5		
3			6		
			7		
			8		
			9		
			10		

Revise:  
Revise:  
Revise:

Revise:  
Revise:  
Revise:

1-1. PUT PRODUCT IN COMPONENT AREA, FORMING OF PRODUCT IS THE SAME DIRECTION TO CARRIER TAPE.  
 1-2. SMT SURFACE TOWARDS TO THE BOTTOM.

2-1. ADHERE OR HEAT COVER TAPE & CARRIER FOR SEALING. STICK END OF THE CARRIER ON THE HUB'S OPENING WITH TRANSPARENT TAPE.

2-2. LABEL MUST BE STICKED ON THE OUTSIDE OF THE REEL, NEARLY THE START POINT.

2-3 PARTS PER RELL 2000PCS

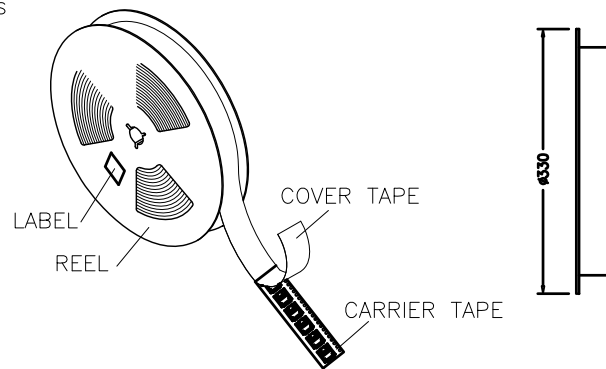
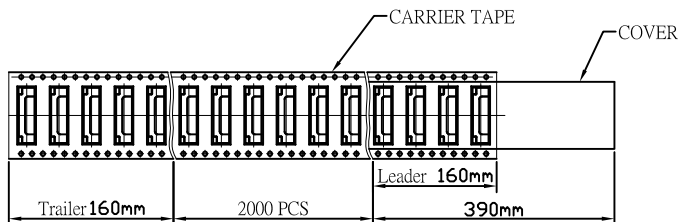

3-1. REEL FACE WITH LABEL UP.

3-2. PUT CUSHION INTO 4 CORNERS OF BOX. AS INDICATED IN PACKING LIST.

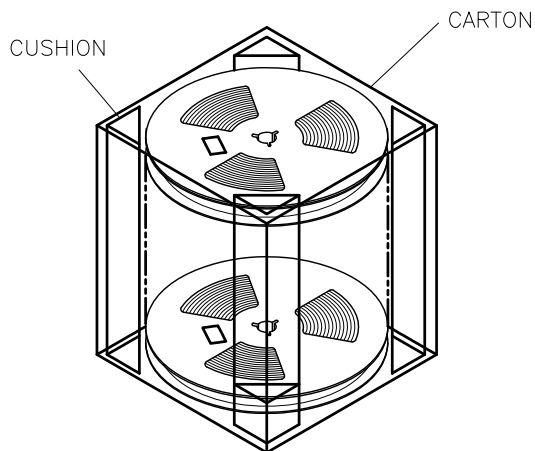



4-1. CARTON DIMENSION : 350 X 350 X 340 mm

4-2. STAPLES SHOULD ONLY BE USED TO SET UP CARTON. ALL CARTONS CLOSURES MUST BE DONE WITH TAPE.

4-3. MUST STICK THE PRODUCT LABEL (P/N, QUANTITIES & DATE ) ON THE LEFT SIDE OF THE CARTON.

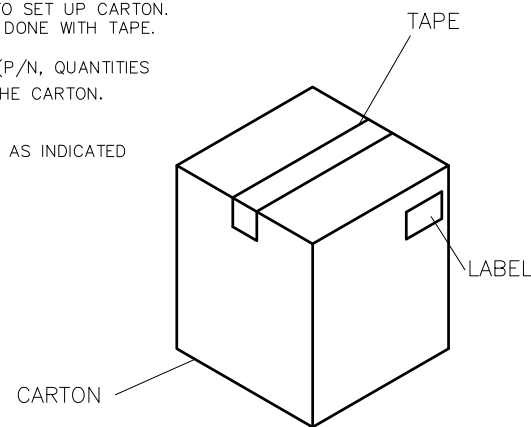
4-4. FILL CARTON WITH THE QUANTITIES AS INDICATED IN PACKING LIST.



						UNLESS OTHERWISE SPECIFIED TOLERANCE			 www.attend.com.tw	
						ANGLES	ANG.	±5°		
						LINEAR	0.	±0.3		
							0.0	±0.25		
						0.00	±0.20	SCALE AS SHOWN	UNIT: mm	
△	Revise:					DRAWN	Willis	2012/08/03	DRAWN NAME: FPC Connector Pitch:0.5mm H:2.0mm Packaging drawing	
△	Revise:					CHECKED	Angel	2012/08/03	PRODUCT NO. 311A-XXXAA-R	
△	Revise:					APPROVED	Ken	2012/08/03	REV. 1.0	
REV.	DESCRIPTION			DATE	REV.	DESCRIPTION			DATE	FILE NAME
1					4					311A-XXXAA-R_D_1