

# SMF4L Series

## Surface Mount – 400W



### Additional Information



Resources



Accessories



Samples

### Agency Approvals

Agency	Agency File Number
	E230531

### Maximum Ratings and Thermal Characteristics

( $T_A = 25^\circ\text{C}$  unless otherwise noted)

Parameter	Symbol	Value	Unit	
Peak Pulse Power Dissipation at $T_A = 25^\circ\text{C}$ (Note 1)	$P_{PPM}$	8/20 $\mu\text{s}$ (Note2)	2000	W
		10/1000 $\mu\text{s}$ (Note3)	400	W
Power Dissipation On Infinite Heat Sink at $T_L = 50^\circ\text{C}$	$P_D$	1	W	
Thermal Resistance Junction to Ambient	$R_{\theta JA}$	220	$^\circ\text{C/W}$	
Thermal Resistance Junction to Lead	$R_{\theta JL}$	100	$^\circ\text{C/W}$	
Operating and Storage Temperature Range	$T_J, T_{STG}$	-55 to 150	$^\circ\text{C}$	

#### Notes:

- Non-repetitive current pulse, per Fig. 4 and derated above  $T_J$  (initial)  $= 25^\circ\text{C}$  per Fig. 3.
- SMF4L5.0A-SMF4L8.5A Peak Pulse Power Dissipation is 1850W min, 2000W typical @ 8/20 $\mu\text{s}$
- SMF4L5.0A-SMF4L8.5A Peak Pulse Power Dissipation is 370W min, 400W typical @ 10/1000 $\mu\text{s}$ , SMF4L90A-SMF4L250A Peak Pulse Power Dissipation is 200W typical @ 10/1000 $\mu\text{s}$

### Description

The SMF4L series of SOD-123FL small and flat lead low-profile plastic package is designed specifically to protect sensitive electronic equipment from voltage transients induced by lightning and other transient voltage events.

### Features & Benefits

- 400W peak pulsepower capability at 10/1000 $\mu\text{s}$  waveform, repetition rate (duty cycle): 0.01%
- Compatible with industrial standard package SOD-123FL
- Low profile: maximum height of 1mm.
- Low inductance, excellent clamping capability
- For surface mounted applications to optimize board space
- Typical failure mode is short from over-specified voltage or current
- Whisker test is conducted based on JEDEC JESD201A per its table 4a and 4c
- IEC-61000-4-2 ESD 30kV(Air), 30kV (Contact)
- ESD protection of data lines in accordance with IEC 61000-4-2
- EFT protection of data lines in accordance with IEC 61000-4-4
- Fast response time: typically less than 1.0ns from 0 Volts to VBR min
- High temperature soldering: 260 $^\circ\text{C}$ /30 seconds at terminals
- VBR @  $T_J = \text{VBR}@25^\circ\text{C} \times (1 + \alpha T \times (T_J - 25))$  ( $\alpha T$ : Temperature Coefficient, typical value is 0.1%)
- Glass passivated junction
- Built-in strain relief
- Plastic package is flammability rated V-0 per Underwriters Laboratories
- Meet MSL level1, per J-STD-020, LF maximum peak of 260 $^\circ\text{C}$
- Matte tin lead-free plated
- Halogen-free and RoHS compliant
- Pb-free E3 means 2nd level interconnect is Pb-free and the terminal finish material is tin(Sn) (IPC/JEDEC J-STD-609A.01)
- Recognized to UL 497B as an Isolated Loop Circuit Protector

### Applications

SMF4L devices are ideal for the protection of I/O interfaces, VCC bus and other vulnerable circuit used in cellular phones, portable devices, business machines, power supplies and other consumer applications.

### Functional Diagram



Bi-directional



Uni-directional

# SMF4L Series

## Surface Mount – 400W

### Electrical Characteristics ( $T_A=25\text{ }^\circ\text{C}$ unless otherwise noted)

Part Number		Marking Code		Breakdown Voltage $V_{BR}$ (Volts) @ $I_T$		Test Current $I_T$ (mA)	Reverse Stand off Voltage $V_R$ (V)	Maximum Reverse Leakage @ $V_R$ $I_R$ ( $\mu\text{A}$ )	Maximum Peak Pulse Current $I_{PP}$ (A)	Maximum Clamping Voltage @ $I_{PP}$ $V_C$ (V)	Agency Approval
Uni-directional	Bi-directional	Uni-directional	Bi-directional	Min	Max						
SMF4L5.0A	-	KE	-	6.40	7.00	10	5.0	800	40.1	9.2	X
SMF4L6.0A	-	KG	-	6.67	7.37	10	6.0	800	35.9	10.3	X
SMF4L6.5A	-	KK	-	7.22	7.98	10	6.5	500	33.1	11.2	X
SMF4L7.0A	-	KM	-	7.78	8.60	10	7.0	200	30.9	12.0	X
SMF4L7.5A	-	KP	-	8.33	9.21	1	7.5	100	28.7	12.9	X
SMF4L8.0A	-	KR	-	8.89	9.83	1	8.0	50	27.2	13.6	X
SMF4L8.5A	-	KT	-	9.44	10.40	1	8.5	20	25.7	14.4	X
SMF4L9.0A	SMF4L9.0CA	KV	AV	10.00	11.10	1	9.0	5	26.4	15.4	X
SMF4L10A	SMF4L10CA	KX	AX	11.10	12.30	1	10	5	23.5	17.0	X
SMF4L11A	SMF4L11CA	KZ	AZ	12.2	13.50	1	11	1	22.0	18.2	X
SMF4L12A	SMF4L12CA	LE	BE	13.30	14.70	1	12	1	20.1	19.9	X
SMF4L13A	SMF4L13CA	LG	BG	14.40	15.90	1	13	1	18.6	21.5	X
SMF4L14A	SMF4L14CA	LK	BK	15.60	17.20	1	14	1	17.2	23.2	X
SMF4L15A	SMF4L15CA	LM	BM	16.70	18.50	1	15	1	16.4	24.4	X
SMF4L16A	SMF4L16CA	LP	BP	17.80	19.70	1	16	1	15.4	26.0	X
SMF4L17A	SMF4L17CA	LR	BR	18.90	20.90	1	17	1	14.5	27.6	X
SMF4L18A	SMF4L18CA	LT	BT	20.00	22.10	1	18	1	13.7	29.2	X
SMF4L20A	SMF4L20CA	LV	BV	22.20	24.50	1	20	1	12.3	32.4	X
SMF4L22A	SMF4L22CA	LX	BX	24.40	26.90	1	22	1	11.3	35.5	X
SMF4L24A	SMF4L24CA	LZ	BZ	26.70	29.50	1	24	1	10.3	38.9	X
SMF4L26A	SMF4L26CA	ME	CE	28.90	31.90	1	26	1	9.5	42.1	X
SMF4L28A	SMF4L28CA	MG	CG	31.10	34.40	1	28	1	8.8	45.4	X
SMF4L30A	SMF4L30CA	MK	CK	33.30	36.80	1	30	1	8.3	48.4	X
SMF4L33A	SMF4L33CA	MM	CM	36.70	40.60	1	33	1	7.5	53.3	X
SMF4L36A	SMF4L36CA	MP	CP	40.00	44.20	1	36	1	6.9	58.1	X
SMF4L40A	SMF4L40CA	MR	CR	44.40	49.10	1	40	1	6.2	64.5	X
SMF4L43A	SMF4L43CA	MT	CT	47.80	52.80	1	43	1	5.8	69.4	X
SMF4L45A	SMF4L45CA	MV	CV	50.00	55.30	1	45	1	5.5	72.7	X
SMF4L48A	SMF4L48CA	MX	CX	53.30	58.90	1	48	1	5.2	77.4	X
SMF4L51A	SMF4L51CA	MZ	CZ	56.70	62.70	1	51	1	4.9	82.4	X
SMF4L54A	-	NE	-	60.00	66.30	1	54	1	4.6	87.1	X
SMF4L58A	-	NG	-	64.40	71.20	1	58	1	4.3	93.6	X
SMF4L60A	-	NK	-	66.70	73.70	1	60	1	4.1	96.8	X
SMF4L64A	-	NM	-	71.10	78.60	1	64	1	3.9	103.0	X
SMF4L70A	-	NP	-	77.80	86.00	1	70	1	3.5	113.0	X
SMF4L75A	-	NR	-	83.30	92.10	1	75	1	3.3	121.0	X
SMF4L78A	-	NT	-	86.70	95.80	1	78	1	3.2	126.0	X
SMF4L85A	-	NV	-	94.40	104.00	1	85	1	2.9	137.0	X
SMF4L90A	-	NX	-	100.00	111.00	1	90	1	1.4	146.0	X
SMF4L100A	-	NZ	-	111.00	123.00	1	100	1	1.2	162.0	X
SMF4L110A	-	OE	-	122.00	135.00	1	110	1	1.1	177.0	X
SMF4L120A	-	OG	-	133.00	147.00	1	120	1	1.0	193.0	X
SMF4L130A	-	OK	-	144.00	159.00	1	130	1	1.0	209.0	X
SMF4L150A	-	OM	-	167.00	185.00	1	150	1	0.8	243.0	X
SMF4L160A	-	OP	-	178.00	197.00	1	160	1	0.8	259.0	X
SMF4L170A	-	OR	-	189.00	209.00	1	170	1	0.7	275.0	X
SMF4L180A	-	OT	-	201.00	222.00	1	180	1	0.7	292.0	-
SMF4L188A	-	OV	-	209.00	231.00	1	188	1	0.7	304.0	-
SMF4L200A	-	OX	-	224.00	247.00	1	200	1	0.6	324.0	-
SMF4L220A	-	OZ	-	246.00	272.00	1	220	1	0.6	356.0	-
SMF4L250A	-	PE	-	279.00	309.00	1	250	1	0.5	405.0	-

#### Notes:

- $V_{BR}$  measured after  $I_T$  applied for 300 $\mu\text{s}$ ,  $I_T$  = square wave pulse or equivalent.
- Surge current waveform per 10/1000 $\mu\text{s}$  exponential wave and derated per Fig.3.
- All terms and symbols are consistent with ANSI/IEEE C62.35.

# SMF4L Series

## Surface Mount – 400W

### I-V Curve Characteristics

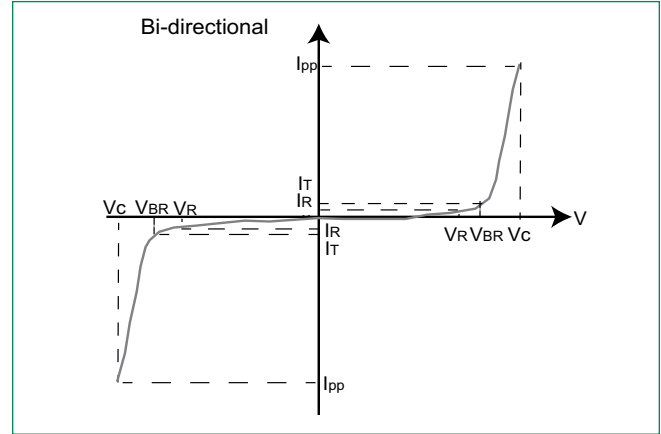
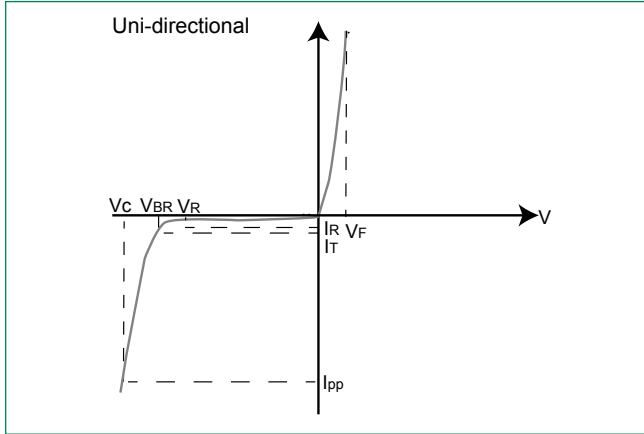

- $P_{PPM}$  Peak Pulse Power Dissipation** -- Max power dissipation
- $V_R$  Stand-off Voltage** -- Maximum voltage that can be applied to the TVS without operation
- $V_{BR}$  Breakdown Voltage** -- Maximum voltage that flows though the TVS at a specified test current ( $I_T$ )
- $V_C$  Clamping Voltage** -- Peak voltage measured across the TVS at a specified  $I_{ppm}$  (peak impulse current)
- $I_R$  Reverse Leakage Current** -- Current measured at  $V_R$
- $V_F$  Forward Voltage Drop for Uni-directional**

### Ratings and Characteristic Curves ( $T_A=25^\circ\text{C}$ unless otherwise noted)

**Figure 1 -**  
TVS Transients Clamping Waveform

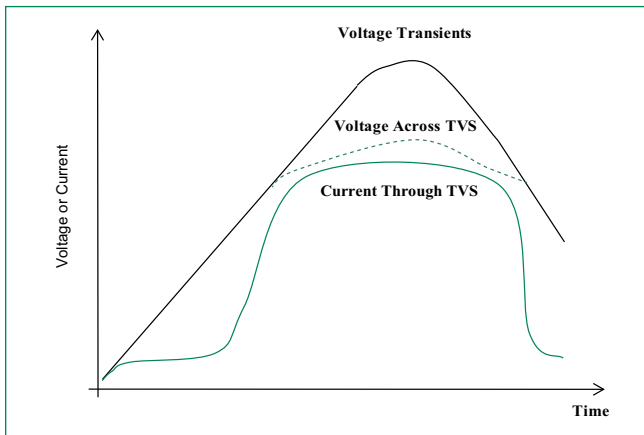

**Figure 2 -**  
Peak Pulse Power Rating Curve

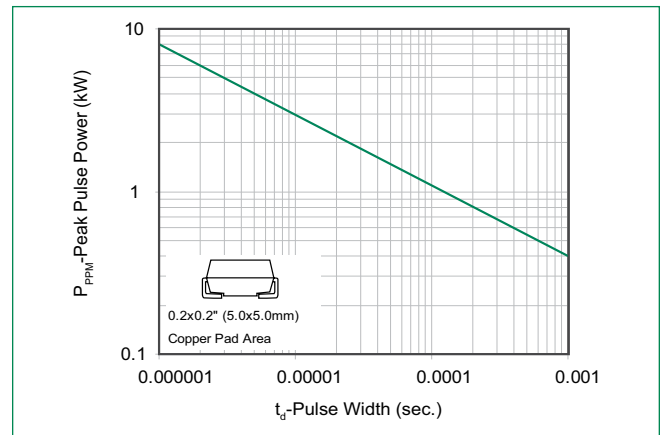

# SMF4L Series

## Surface Mount – 400W

### Ratings and Characteristic Curves ( $T_A=25\text{ }^\circ\text{C}$ unless otherwise noted) (Continued)

**Figure 3 -**  
Peak Pulse Power Derating Curve

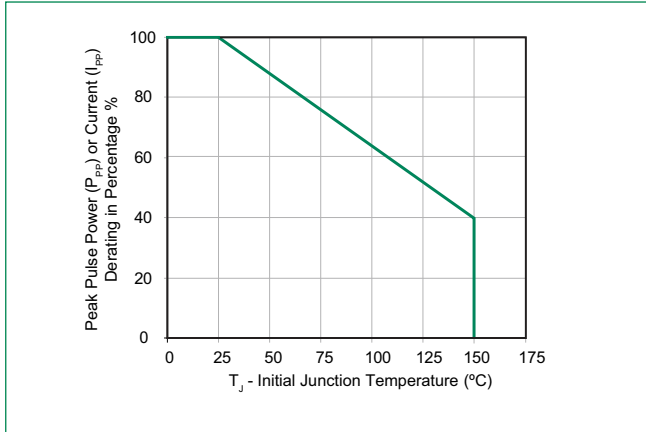

**Figure 4 -**  
Pulse Waveform - 10/1000 $\mu\text{S}$

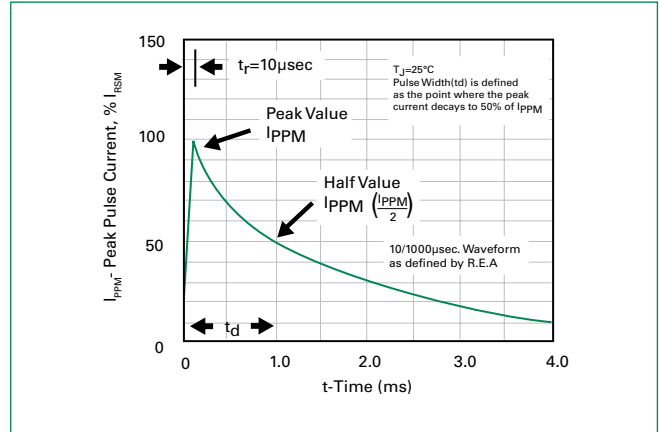

**Figure 5 -**  
Forward Voltage

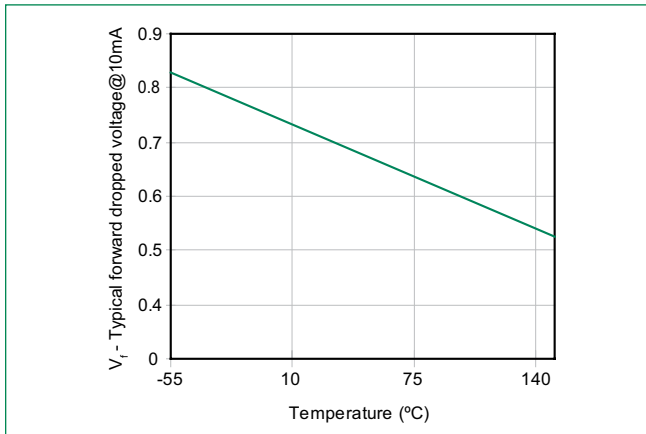

**Figure 6 -**  
Typical Junction Capacitance

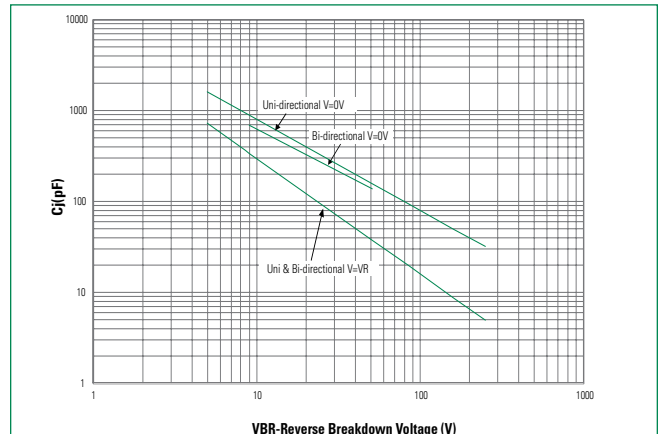

**Figure 7 -**  
Peak Forward Voltage Drop vs. Peak Forward Current

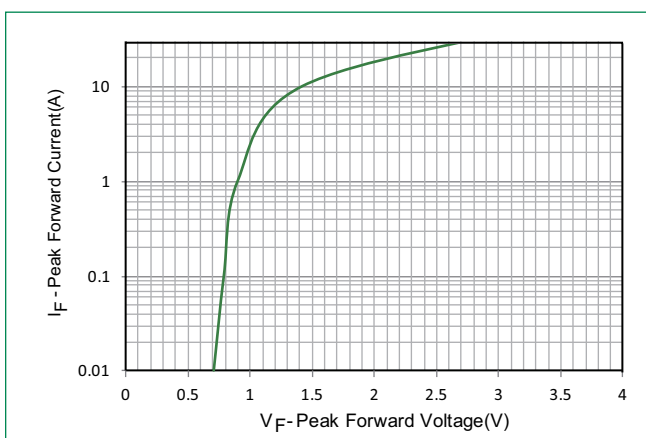

**Figure 8 -**  
Maximum Non-Repetitive Forward Surge Current  
Uni-Directional Only

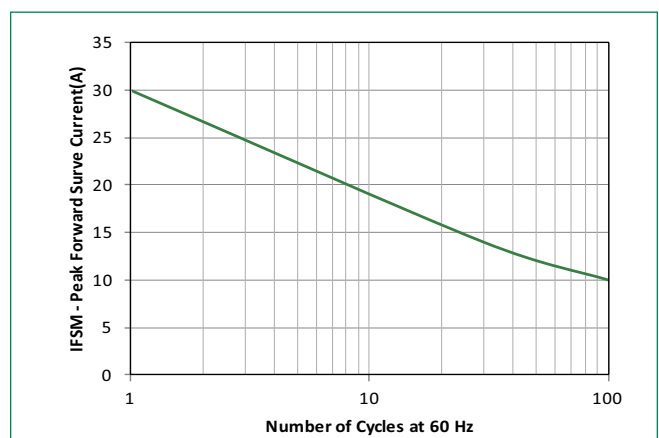

# SMF4L Series

## Surface Mount – 400W

### Soldering Parameters

<b>Reflow Condition</b>		Lead-free assembly
<b>Pre Heat</b>	- Temperature Min ( $T_{s(min)}$ )	150°C
	- Temperature Max ( $T_{s(max)}$ )	200°C
	- Time (min to max) ( $t_p$ )	60 – 120 secs
<b>Average ramp up rate (Liquidus Temp (<math>T_L</math>) to peak)</b>		3°C/second max
<b><math>T_{s(max)}</math> to <math>T_L</math> - Ramp-up Rate</b>		3°C/second max
<b>Reflow</b>	- Temperature ( $T_L$ ) (Liquidus)	217°C
	- Time (min to max) ( $t_L$ )	60 – 150 seconds
<b>Peak Temperature (<math>T_p</math>)</b>		260 <sup>+0/-5</sup> °C
<b>Time within 5°C of actual peak Temperature (<math>t_p</math>)</b>		30 seconds Max
<b>Ramp-down Rate</b>		6°C/second max
<b>Time 25°C to peak Temperature (<math>T_p</math>)</b>		8 minutes Max.
<b>Do not exceed</b>		260°C

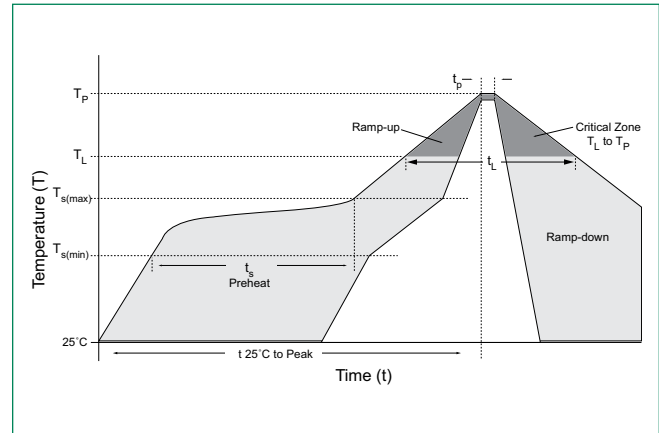

### Physical Specifications

<b>Case</b>	SOD-123FL plastic over glass passivated junction
<b>Polarity</b>	Color band denotes cathode except bipolar
<b>Terminal</b>	Matte tin-plated leads, solderable per JESD22-B102

### Environmental Specifications

<b>High Temp. Storage</b>	JESD22-A103
<b>HTRB</b>	JESD22-A108
<b>Temperature Cycling</b>	JESD22-A104
<b>MSL</b>	JEDEC-J-STD-020, Level 1
<b>H3TRB</b>	JESD22-A101
<b>RSH</b>	JESD22-A111

### Dimensions - SOD-123FL Package

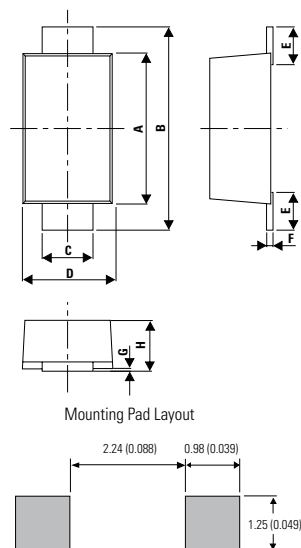

Dimensions	Millimeters		Inches	
	Min	Max	Min	Max
<b>A</b>	2.90	3.10	0.114	0.122
<b>B</b>	3.50	3.90	0.138	0.154
<b>C</b>	0.85	1.05	0.033	0.041
<b>D</b>	1.70	2.00	0.067	0.079
<b>E</b>	0.43	0.83	0.017	0.033
<b>F</b>	0.10	0.25	0.004	0.010
<b>G</b>	0.00	0.10	0.000	0.004
<b>H</b>	0.90	1.08	0.035	0.043

# SMF4L Series

## Surface Mount – 400W

### Part Numbering System

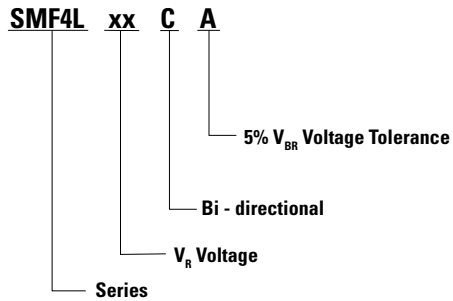

### Part Marking System

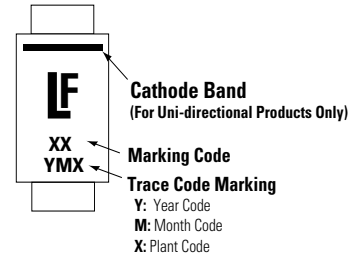

### Packaging Options

Part number	Component Package	Quantity	Packaging Option	Packaging Specification
SMF4LXXX	SOD-123FL	3000	Tape & Reel – 8mm tape/7" reel	EIA RS-481

### Tape and Reel Specification

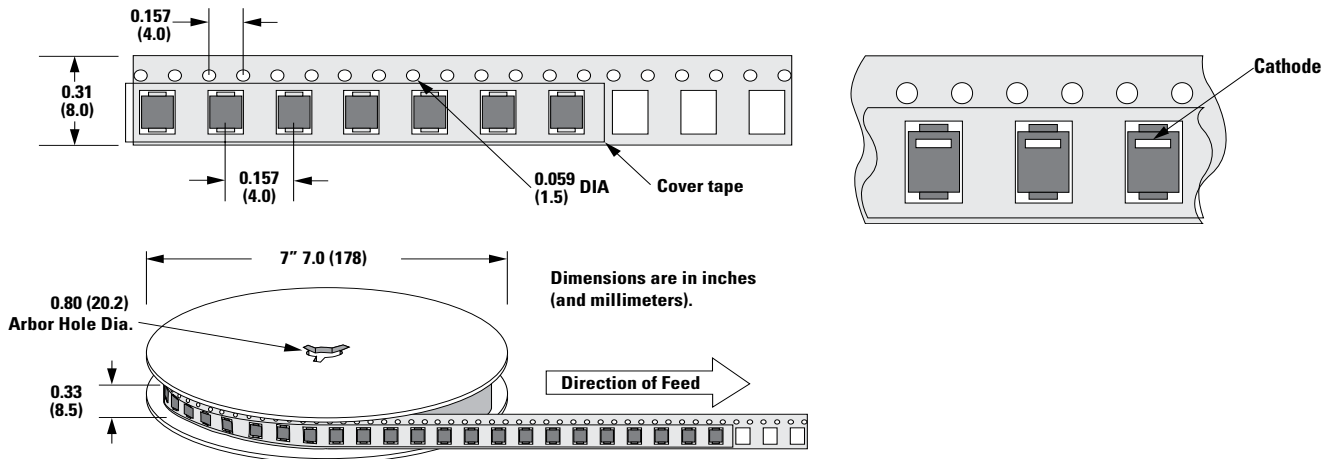

**Disclaimer Notice** - Information furnished is believed to be accurate and reliable. However, users should independently evaluate the suitability of and test each product selected for their own applications. Littelfuse products are not designed for, and may not be used in, all applications. Read complete Disclaimer Notice at: [www.littelfuse.com/disclaimer-electronics](http://www.littelfuse.com/disclaimer-electronics).

# Mouser Electronics

Authorized Distributor

Click to View Pricing, Inventory, Delivery & Lifecycle Information:

[Littelfuse:](#)

[SMF4L15A](#) [SMF4L7.5A](#) [SMF4L5.0A](#) [SMF4L75A](#) [SMF4L20A](#) [SMF4L17A](#) [SMF4L30A](#) [SMF4L8.0A](#) [SMF4L13A](#)  
[SMF4L43A](#) [SMF4L22A](#) [SMF4L14A](#) [SMF4L10A](#) [SMF4L8.5A](#) [SMF4L11A](#) [SMF4L64A](#) [SMF4L48A](#) [SMF4L58A](#)  
[SMF4L60A](#) [SMF4L28A](#) [SMF4L6.5A](#) [SMF4L33A](#) [SMF4L78A](#) [SMF4L85A](#) [SMF4L36A](#) [SMF4L9.0A](#) [SMF4L18A](#)  
[SMF4L70A](#) [SMF4L26A](#) [SMF4L6.0A](#) [SMF4L51A](#) [SMF4L40A](#) [SMF4L7.0A](#) [SMF4L45A](#) [SMF4L12A](#) [SMF4L16A](#)  
[SMF4L54A](#) [SMF4L24A](#) [SMF4L150A](#) [SMF4L120A](#) [SMF4L180A](#) [SMF4L160A](#) [SMF4L220A](#) [SMF4L130A](#)  
[SMF4L250A](#) [SMF4L188A](#) [SMF4L170A](#) [SMF4L100A](#) [SMF4L110A](#) [SMF4L200A](#) [SMF4L90A](#) [SMF4L45CA](#)  
[SMF4L15CA](#) [SMF4L33CA](#) [SMF4L10CA](#) [SMF4L17CA](#) [SMF4L9.0CA](#) [SMF4L14CA](#) [SMF4L48CA](#) [SMF4L16CA](#)  
[SMF4L28CA](#) [SMF4L30CA](#) [SMF4L12CA](#) [SMF4L24CA](#) [SMF4L36CA](#) [SMF4L43CA](#) [SMF4L11CA](#) [SMF4L40CA](#)  
[SMF4L13CA](#) [SMF4L51CA](#) [SMF4L18CA](#) [SMF4L22CA](#) [SMF4L26CA](#) [SMF4L20CA](#)