

NUF2441FC

Integrated Passive Filter with ESD Protection

This device is designed for cell phone applications requiring **Headset and Speaker Phone, EMI Filtering and ESD Protection**. This device offers an integrated solution in a small package reducing PCB space and cost.

Features:

- Provides EMI Filtering and ESD Protection
- Single IC Offers Cost Savings by Replacing 2 Inductors, 4 Capacitors, and 4 TVs Diodes
- Compliance with IEC61000-4-2, (Level 4) 30 kV (Contact), 30 kV (air)
- Flip-Chip Package
- Moisture Sensitivity Level 1
- ESD Ratings: Machine Model = C
Human Body Model = 3B
- Pb-Free Package is Available*

Benefits:

- Flip-Chip Package Minimizes PCB Space
- Integrated Circuit Increases System Reliability versus Discrete Component Implementation
- TVs Devices Provide ESD Protection That is Better than a Discrete Implementation because the Small IC minimizes Parasitic Inductances

Typical Applications:

- Cell Phones
- Communication Circuits

MAXIMUM RATINGS (T_A = 25°C)

Rating	Symbol	Value	Unit
ESD Discharge IEC61000-4-2 Contact Discharge Air Discharge	V _{pp}	30 30	kV
Operating Temperature Range	T _J	-40 to +125	°C
Storage Temperature Range	T _{stg}	-55 to +150	°C
Lead Solder Temperature (10 second duration)	T _L	260	°C

Stresses exceeding Maximum Ratings may damage the device. Maximum Ratings are stress ratings only. Functional operation above the Recommended Operating Conditions is not implied. Extended exposure to stresses above the Recommended Operating Conditions may affect device reliability.

*For additional information on our Pb-Free strategy and soldering details, please download the ON Semiconductor Soldering and Mounting Techniques Reference Manual, SOLDERRM/D.



ON Semiconductor[®]

<http://onsemi.com>

CIRCUIT DESCRIPTION

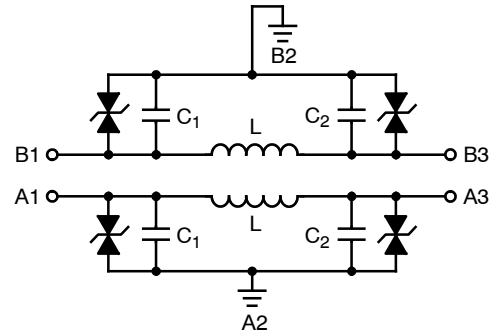

MARKING DIAGRAM



A1

**Flip-Chip
CASE 499J**

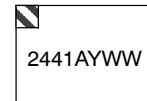

2441 = Specific Device Code
A = Assembly Location
Y = Year
WW = Work Week

PIN CONFIGURATION

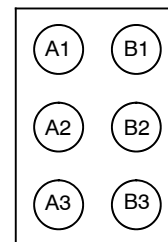

(Bump View)

ORDERING INFORMATION

Package	Device	Shipping [†]
NUF2441FCT1	Flip-Chip	3000/Tape & Reel
NUF2441FCT1G	Flip-Chip (Pb-Free)	3000/Tape & Reel

[†]For information on tape and reel specifications, including part orientation and tape sizes, please refer to our Tape and Reel Packaging Specification Brochure, BRD8011/D.

NUF2441FC

ELECTRICAL CHARACTERISTICS ($T_A = 25^\circ\text{C}$)

Device	Device Marking	V_{RWM} (Volts)	V_{BR} @ 1 mA (Volts)		Max I_R @ $V_{RWM} = 12\text{ V}$ I/O Pin (μA)	Typical Capacitance $C_1 + C_2$ (pF) (Notes 1, 3, 4)	Typical Pass-Band Inductance L (nH)	Equivalent Series Resistance R_S (Ω) (Note 2)	
			Min	Max				Typ	Max
NUF2441FCT1G	2441	12	13.7	17.7	0.1	250	2.9	0.28	0.35

1. Measured at 25°C , $V_R = 0$, $f = 1\text{ MHz}$, Source A1, GND A2, Open A3.
2. Measured at room temperature.
3. Tolerance = $\pm 20\%$.
4. Measured under zero light conditions.

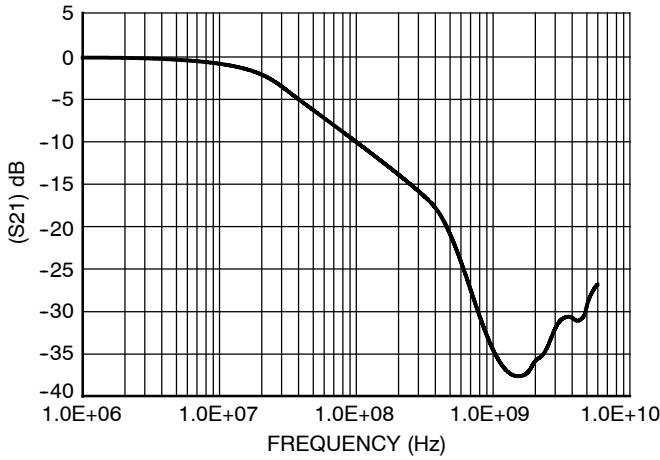

Figure 1. Insertion Loss Characteristic

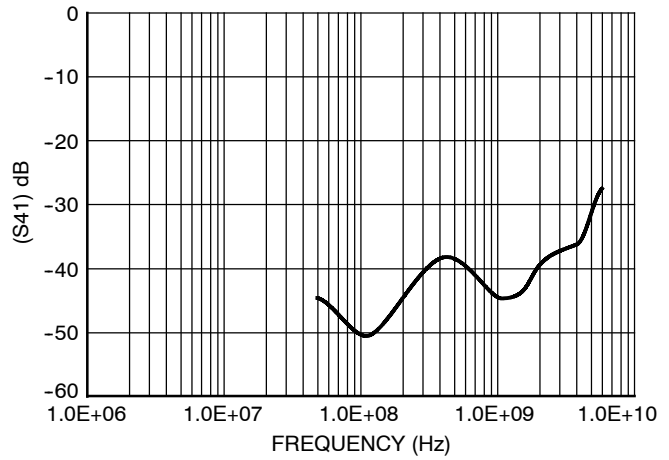

Figure 2. Analog Crosstalk

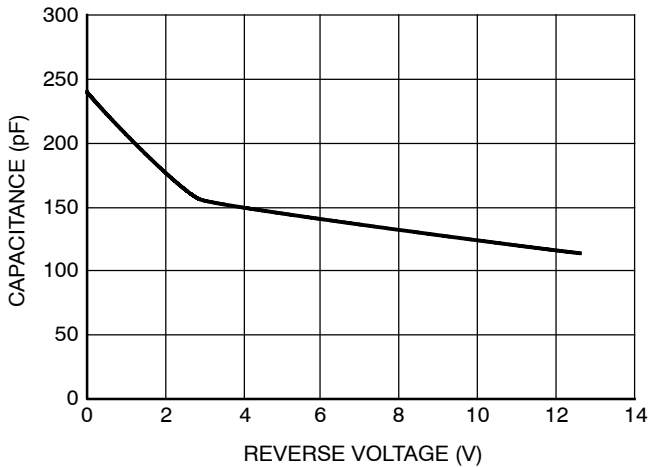

Figure 3. Typical Line Capacitance vs. Reverse Bias Voltage

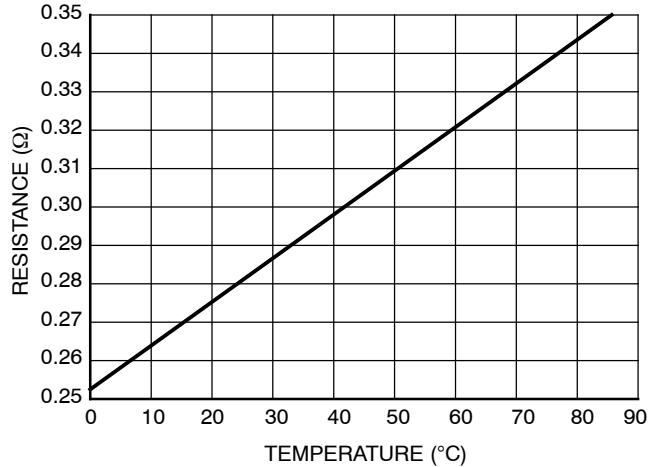

Figure 4. Typical Resistance vs. Temperature

MECHANICAL CASE OUTLINE

PACKAGE DIMENSIONS

ON Semiconductor®



A1

SCALE 4:1

6 PIN FLIP-CHIP
1.72x1.22mm, 0.5 PITCH
CASE 499J-01
ISSUE O

DATE 05 FEB 2004

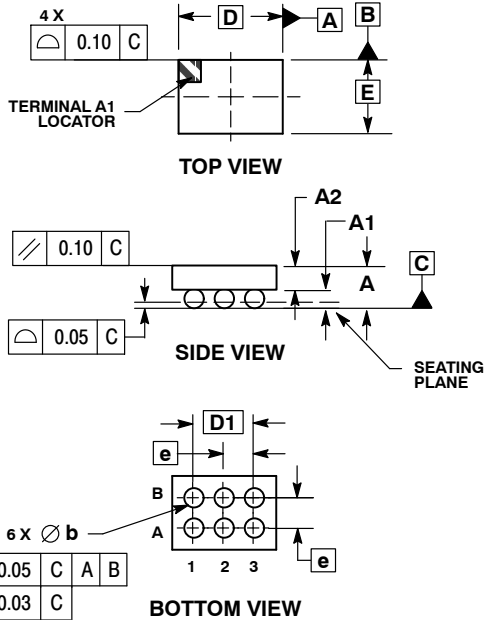

NOTES:

1. DIMENSIONING AND TOLERANCING PER ASME Y14.5M, 1994.
2. CONTROLLING DIMENSION: MILLIMETERS.
3. COPLANARITY APPLIES TO SPHERICAL CROWNS OF SOLDER BALLS.

DIM	MILLIMETERS	
	MIN	MAX
A	---	0.700
A1	0.210	0.270
A2	0.380	0.430
D	1.720 BSC	
E	1.220 BSC	
b	0.290	0.340
e	0.500 BSC	
D1	1.000 BSC	

GENERIC MARKING DIAGRAM*



- xx = Specific Device Code
- A = Assembly Location
- WL, L = Wafer Lot
- YY, Y = Year
- WW, W = Work Week

*This information is generic. Please refer to device data sheet for actual part marking.

DOCUMENT NUMBER:	98AON13950D	Electronic versions are uncontrolled except when accessed directly from the Document Repository. Printed versions are uncontrolled except when stamped "CONTROLLED COPY" in red.
DESCRIPTION:	6 PIN FLIP-CHIP, 1.72x1.22mm, 0.5 PITCH	PAGE 1 OF 1

ON Semiconductor and are trademarks of Semiconductor Components Industries, LLC dba ON Semiconductor or its subsidiaries in the United States and/or other countries. ON Semiconductor reserves the right to make changes without further notice to any products herein. ON Semiconductor makes no warranty, representation or guarantee regarding the suitability of its products for any particular purpose, nor does ON Semiconductor assume any liability arising out of the application or use of any product or circuit, and specifically disclaims any and all liability, including without limitation special, consequential or incidental damages. ON Semiconductor does not convey any license under its patent rights nor the rights of others.

onsemi, **Onsemi**, and other names, marks, and brands are registered and/or common law trademarks of Semiconductor Components Industries, LLC dba "**onsemi**" or its affiliates and/or subsidiaries in the United States and/or other countries. **onsemi** owns the rights to a number of patents, trademarks, copyrights, trade secrets, and other intellectual property. A listing of **onsemi**'s product/patent coverage may be accessed at www.onsemi.com/site/pdf/Patent-Marking.pdf. **onsemi** reserves the right to make changes at any time to any products or information herein, without notice. The information herein is provided "as-is" and **onsemi** makes no warranty, representation or guarantee regarding the accuracy of the information, product features, availability, functionality, or suitability of its products for any particular purpose, nor does **onsemi** assume any liability arising out of the application or use of any product or circuit, and specifically disclaims any and all liability, including without limitation special, consequential or incidental damages. Buyer is responsible for its products and applications using **onsemi** products, including compliance with all laws, regulations and safety requirements or standards, regardless of any support or applications information provided by **onsemi**. "Typical" parameters which may be provided in **onsemi** data sheets and/or specifications can and do vary in different applications and actual performance may vary over time. All operating parameters, including "Typicals" must be validated for each customer application by customer's technical experts. **onsemi** does not convey any license under any of its intellectual property rights nor the rights of others. **onsemi** products are not designed, intended, or authorized for use as a critical component in life support systems or any FDA Class 3 medical devices or medical devices with a same or similar classification in a foreign jurisdiction or any devices intended for implantation in the human body. Should Buyer purchase or use **onsemi** products for any such unintended or unauthorized application, Buyer shall indemnify and hold **onsemi** and its officers, employees, subsidiaries, affiliates, and distributors harmless against all claims, costs, damages, and expenses, and reasonable attorney fees arising out of, directly or indirectly, any claim of personal injury or death associated with such unintended or unauthorized use, even if such claim alleges that **onsemi** was negligent regarding the design or manufacture of the part. **onsemi** is an Equal Opportunity/Affirmative Action Employer. This literature is subject to all applicable copyright laws and is not for resale in any manner.

ADDITIONAL INFORMATION

TECHNICAL PUBLICATIONS:

Technical Library: www.onsemi.com/design/resources/technical-documentation
onsemi Website: www.onsemi.com

ONLINE SUPPORT: www.onsemi.com/support

For additional information, please contact your local Sales Representative at www.onsemi.com/support/sales