

EMI2121, SZEMI2121

Single Pair Common Mode Filter with ESD Protection

Description

The EMI2121 is an integrated common mode filter providing both ESD protection and EMI filtering for high speed serial digital interfaces such as USB2.0.

The EMI2121 provides EMI filtering for one differential data line pair and ESD protection for one data pair plus a supply input such as USB2.0 Vbus or USB ID pin. It is supplied in a small RoHS-compliant WDFN8 package.

Features

- Highly Integrated Common Mode Filter (CMF) with ESD Protection provides protection and EMI Reduction for systems using high speed Serial Data Lines with cost and space savings over Discrete Solutions
- Large Differential Mode Bandwidth with Cutoff Frequency > 2 GHz
- High Common Mode Stop Band Attenuation: >25 dB at 700 MHz, >30 dB at 800 MHz Typical
- Provides ESD Protection to IEC61000-4-2 Level 4, ±12 kV Contact Discharge
- Low Channel Input Capacitance provides Superior Impedance Matching Performance
- Low Profile Package with Small Footprint in WDFN8 2.0 mm length x 2.2 mm width x 0.75 mm height Pb-Free Package
- SZ Prefix for Automotive and Other Applications Requiring Unique Site and Control Change Requirements; AEC-Q101 Qualified and PPAP Capable
- These Devices are Pb-Free, Halogen Free/BFR Free and are RoHS Compliant

Applications

- USB2.0 and other High Speed Differential Data Lines in Mobile Phones, Digital Still Cameras, and Automotive interfaces
- MIPI D-PHY



ON Semiconductor®

www.onsemi.com

SIMPLIFIED SCHEMATIC

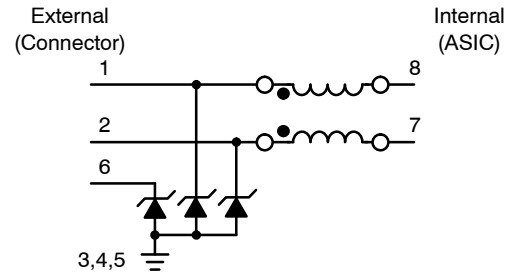

MARKING DIAGRAM

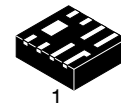

**WDFN8
CASE 511BN**

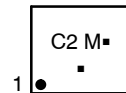

C2 = Specific Device Code
M = Date Code
▪ = Pb-Free Device

(Note: Microdot may be in either location)

PIN CONNECTIONS

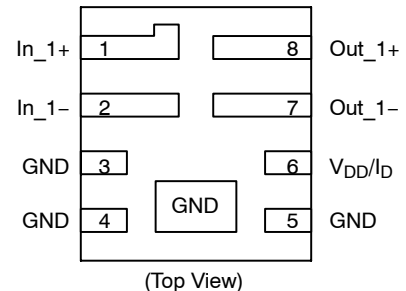

ORDERING INFORMATION

Device	Package	Shipping†
EMI2121MTTAG	WDFN8 (Pb-Free)	3000/Tape & Reel
SZEMI2121MTTAG	WDFN8 (Pb-Free)	3000/Tape & Reel

†For information on tape and reel specifications, including part orientation and tape sizes, please refer to our Tape and Reel Packaging Specification Brochure, BRD8011/D.

EMI2121, SZEMI2121

PIN DESCRIPTION

Pin No.	Pin Name	Type	Description
1	In_1+	I/O	CMF Channel 1+ to Connector (External)
2	In_1-	I/O	CMF Channel 1- to Connector (External)
8	Out_1+	I/O	CMF Channel 1+ to ASIC (Internal)
7	Out_1-	I/O	CMF Channel 1- to ASIC (Internal)
6	V _{DD} /I _D	I/O	Supply Protection to Connector (External)
3,4,5	GND	GND	Ground

MAXIMUM RATINGS (T_A = 25°C unless otherwise stated)

Parameter	Symbol	Value	Units
Operating Temperature Range	T _{OP}	-40 to +85	°C
Storage Temperature Range	T _{STG}	-65 to +150	°C
Maximum Lead Temperature for Soldering Purposes (1/8" from Case for 10 Seconds)	T _L	260	°C
DC Current per Line	I _{LINE}	100	mA

Stresses exceeding those listed in the Maximum Ratings table may damage the device. If any of these limits are exceeded, device functionality should not be assumed, damage may occur and reliability may be affected.

ELECTRICAL CHARACTERISTICS (T_A = 25°C unless otherwise specified)

Parameter	Symbol	Test Conditions	Min	Typ	Max	Unit
Channel Leakage Current	I _{LEAK}	T _A = 25°C, V _{IN} = 5 V, GND = 0 V			1.0	μA
Channel Negative Voltage	V _F	T _A = 25°C, I _F = 10 mA	0.1		1.5	V
Channel Input Capacitance to ground (Pins 1,2,4,5 to Pins 3,8)	C _{IN}	T _A = 25°C, At 1 MHz, GND = 0 V, V _{IN} = 1.65 V		0.8	1.3	pF
Channel Resistance (Pins 1-16, 2-15, 4-13, 5-12, 7-10 and 9-9)	R _{ch}			8.0		Ω
Differential Mode Cut – Off Frequency	f _{3dB}	50 Ω source and load termination		2.0		GHz
Common Mode Stop Band Attenuation	F _{atten}	@ 800 MHz		30		dB
In-system ESD Withstand Voltage a) Contact discharge per IEC 61000-4-2 standard, Level 4 (External Pins) b) Contact discharge per IEC 61000-4-2 standard, Level 1 (Internal Pins)	V _{ESD}	(Notes 1 and 2)	±12 ±2			kV
TLP Clamping Voltage (See Figure 9)	V _{CL}	Forward I _{PP} = 8 A Forward I _{PP} = 12 A Reverse I _{PP} = -8 A Reverse I _{PP} = -12 A		13 16 -6 -8.5		V V V V
Reverse Working Voltage	V _{RWM}	(Note 3)			5.0	V
Breakdown Voltage	V _{BR}	I _T = 1 mA; (Note 4)	5.5		9.0	V
Maximum Peak Pulse Current (Pin 6 to GND)	I _{PP}	8x20 μs Waveform			12	A
Clamping Voltage (Pin 6 to GND)	V _C	I _{PP} = 5 A			10	V
Dynamic Resistance Positive Transients Negative Transients	R _{DYN}	T _A = 25°C, I _{PP} = 1 A, t _p = 8/20 us, Any I/O to GND		0.67 0.59		Ω Ω

- Standard IEC 61000-4-2 with C_{Discharge} = 150 pF, R_{Discharge} = 330, GND grounded.
- These measurements performed with no external capacitor.
- TVS devices are normally selected according to the working peak reverse voltage (V_{RWM}), which should be equal or greater than the DC or continuous peak operating voltage level.
- V_{BR} is measured at pulse test current I_T.

EMI2121, SZEMI2121

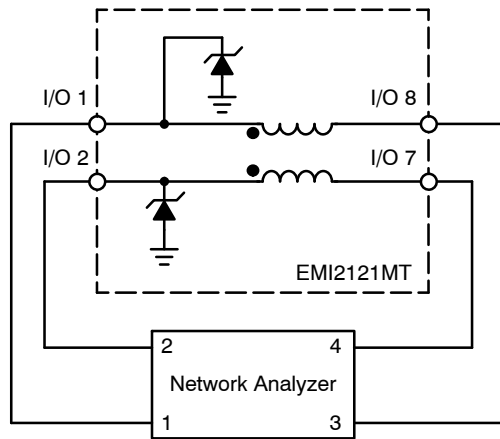

Normal (Differential) Mode

Figure 1. Normal (Differential) Mode Test Configuration

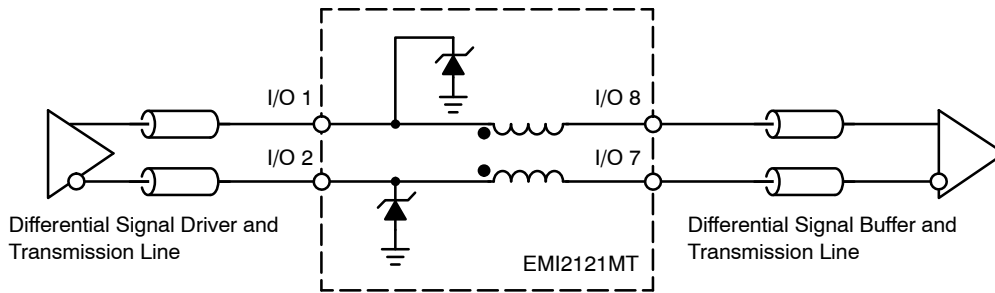

Figure 2. Application Circuit

EMI2121, SZEMI2121

TYPICAL CHARACTERISTICS

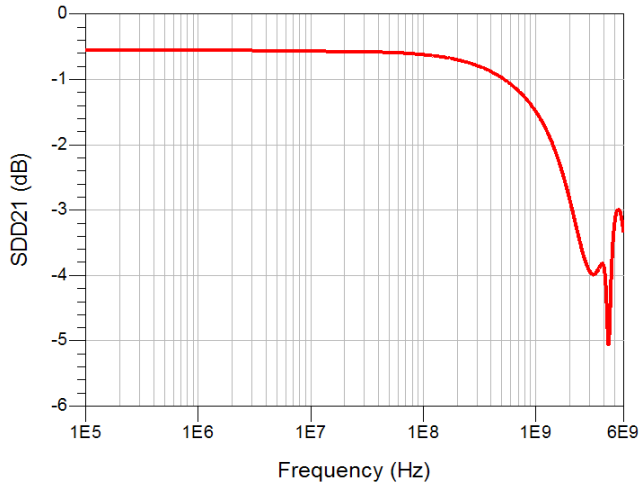

Figure 3. Differential Mode Attenuation vs. Frequency ($Z_{diff} = 100 \Omega$)

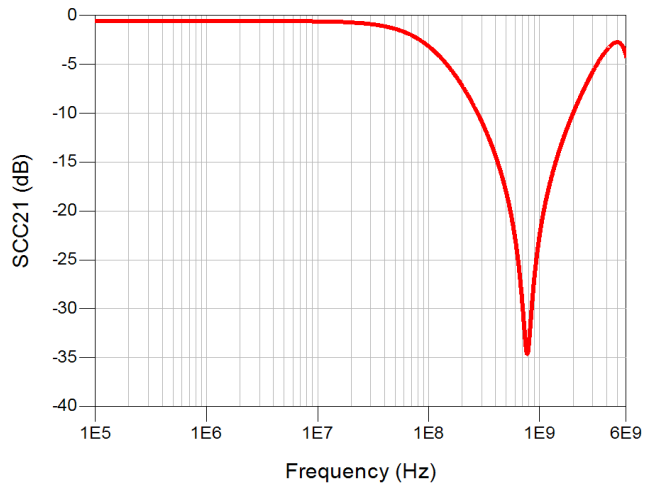

Figure 4. Common Mode Attenuation vs. Frequency ($Z_{comm} = 50 \Omega$)

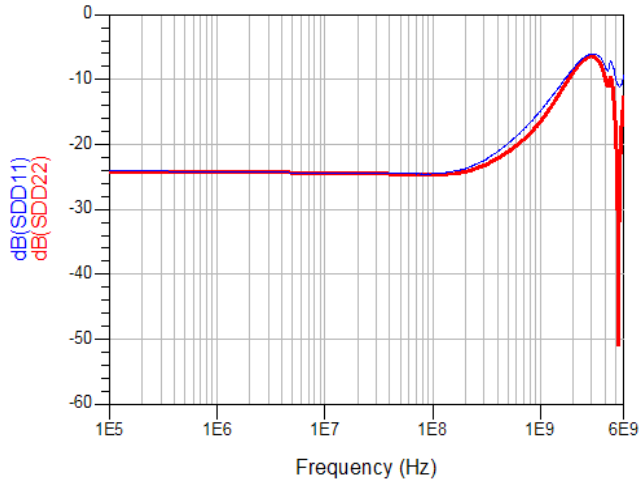

Figure 5. Differential Return Loss vs. Frequency ($Z_{diff}=100 \Omega$)

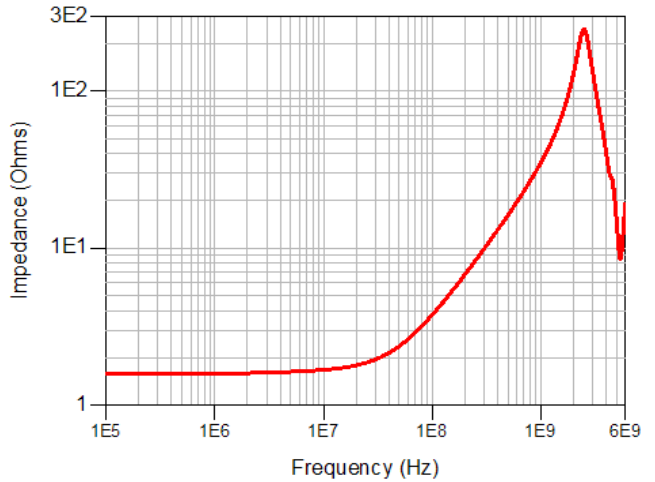

Figure 6. Differential Impedance vs. Frequency ($Z_{diff}=100 \Omega$)

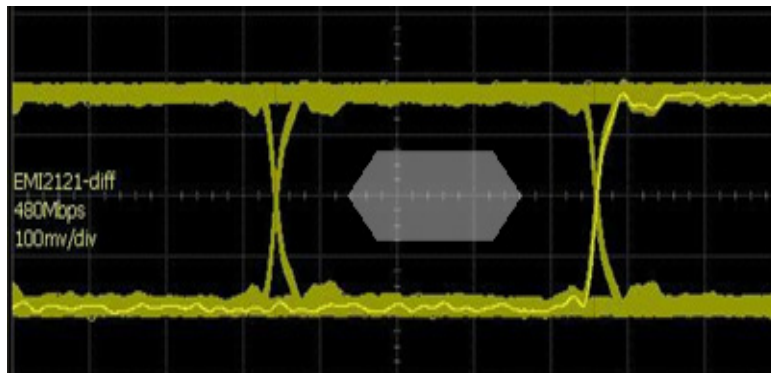

Figure 7. EMI2121 Measured Eye Diagram @ 480 Mbps

Transmission Line Pulse (TLP) Measurements

Transmission Line Pulse (TLP) provides current versus voltage (I-V) curves in which each data point is obtained from a 100 ns long rectangular pulse from a charged transmission line. A simplified schematic of a typical TLP system is shown in Figure 8. TLP I-V curves of ESD protection devices accurately demonstrate the product’s ESD capability because the 10 s of amps current levels and under 100 ns time scale match those of an ESD event. This is illustrated in Figure 9 where an 8 kV IEC61000-4-2 current waveform is compared with TLP current pulses at 8 and 16 A. A TLP curve shows the voltage at which the device turns on as well as how well the device clamps voltage over a range of current levels. Typical TLP I-V curves for the EMI2121 are shown in Figure 10.

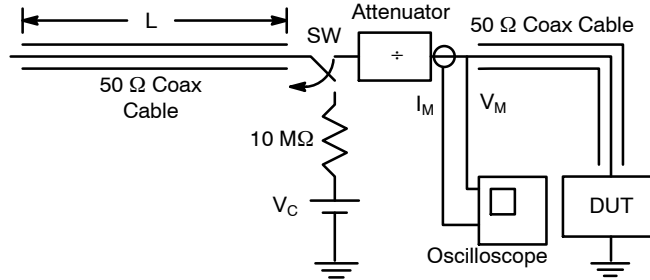

Figure 8. Simplified Schematic of a Typical TLP System

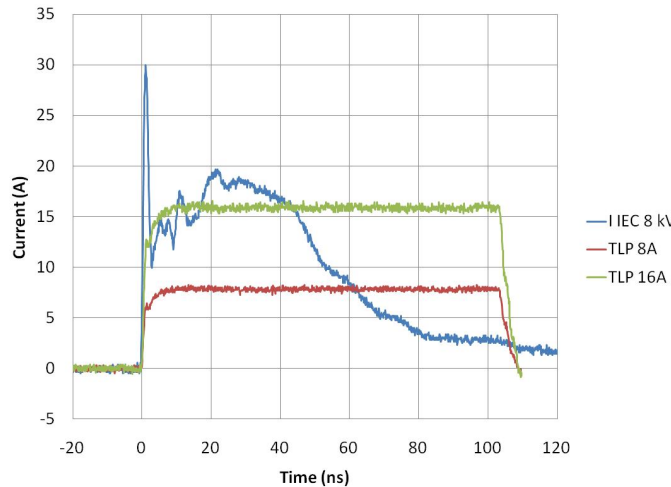

Figure 9. Comparison Between 8 kV IEC61000-4-2 and 8 A and 16 A TLP Waveforms

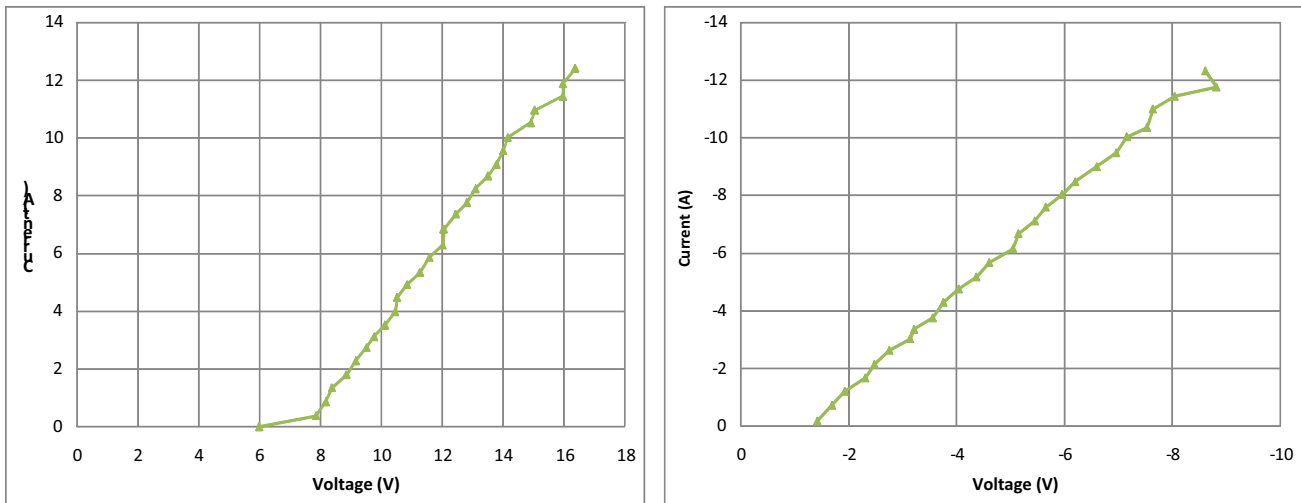

Figure 10. Positive and Negative TLP Waveforms

ESD Voltage Clamping

For sensitive circuit elements it is important to limit the voltage that an IC will be exposed to during an ESD event to as low a voltage as possible. The ESD clamping voltage is the voltage drop across the ESD protection diode during an ESD event per the IEC61000-4-2 waveform. Since the IEC61000-4-2 was written as a pass/fail spec for larger systems such as cell phones or laptop computers it is not clearly defined in the spec how to specify a clamping voltage at the device level. ON Semiconductor has developed a way to examine the entire voltage waveform across the ESD protection diode over the time domain of an ESD pulse in the form of an oscilloscope screenshot, which can be found on the datasheets for all ESD protection diodes. For more information on how ON Semiconductor creates these screenshots and how to interpret them please refer to On Semiconductor Application Notes AND8307/D and AND8308/D.

IEC61000-4-2 Spec.

Level	Test Voltage (kV)	First Peak Current (A)	Current at 30 ns (A)	Current at 60 ns (A)
1	2	7.5	4	2
2	4	15	8	4
3	6	22.5	12	6
4	8	30	16	8

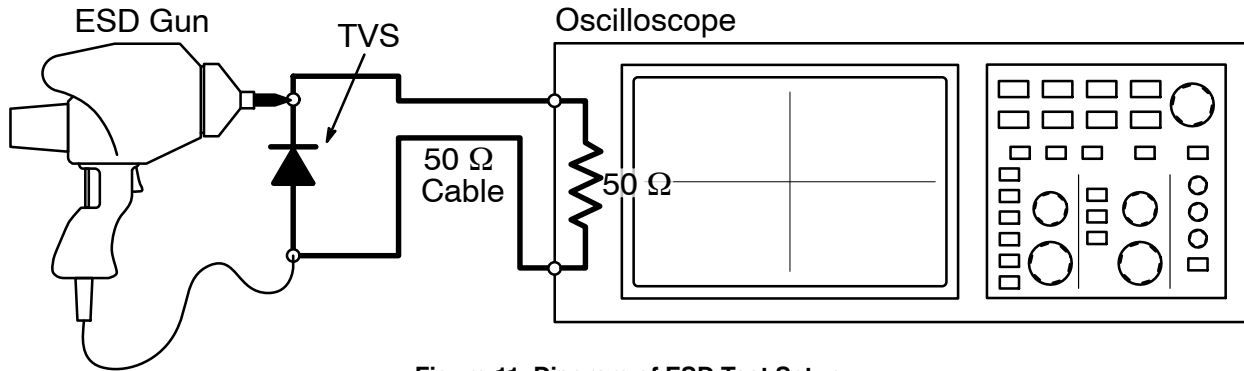
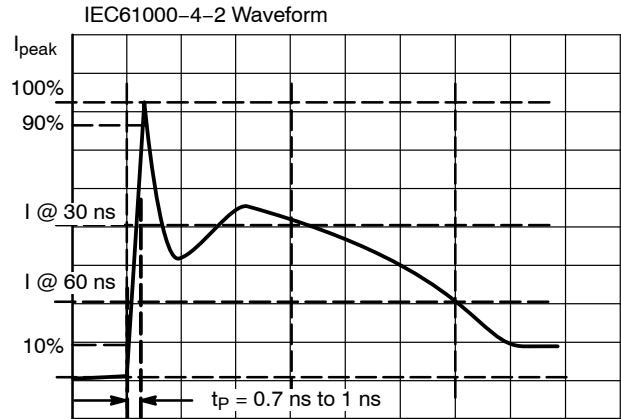

Figure 11. Diagram of ESD Test Setup

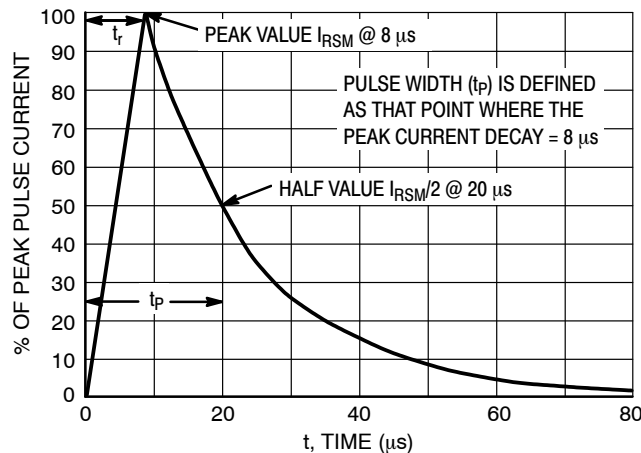

Figure 12. 8 x 20 μ s Pulse Waveform

EMI2121, SZEMI2121

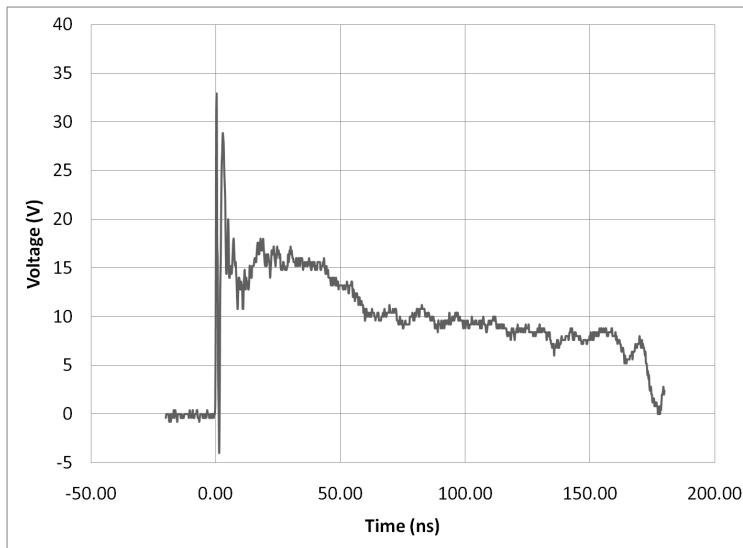

Figure 13. ESD Clamping Voltage +8 kV per IEC6100-4-2 (external to internal pin)

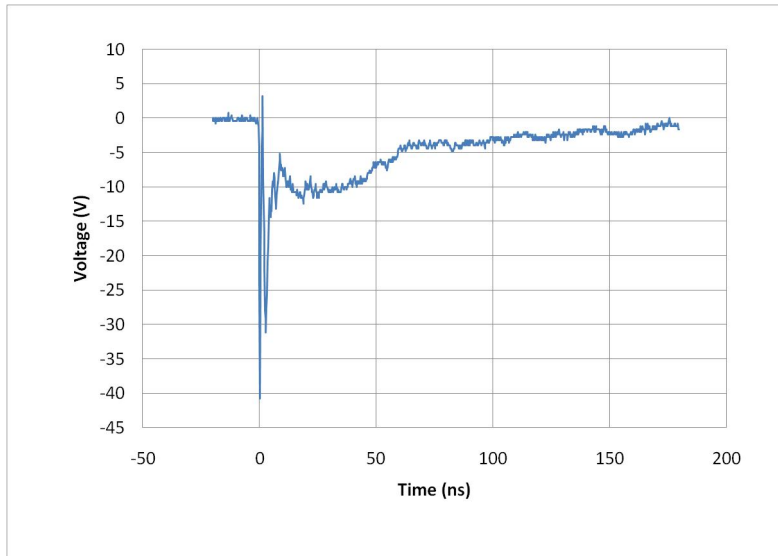

Figure 14. ESD Clamping Voltage -8 kV per IEC6100-4-2 (external to internal pin)

EMI2121, SZEMI2121

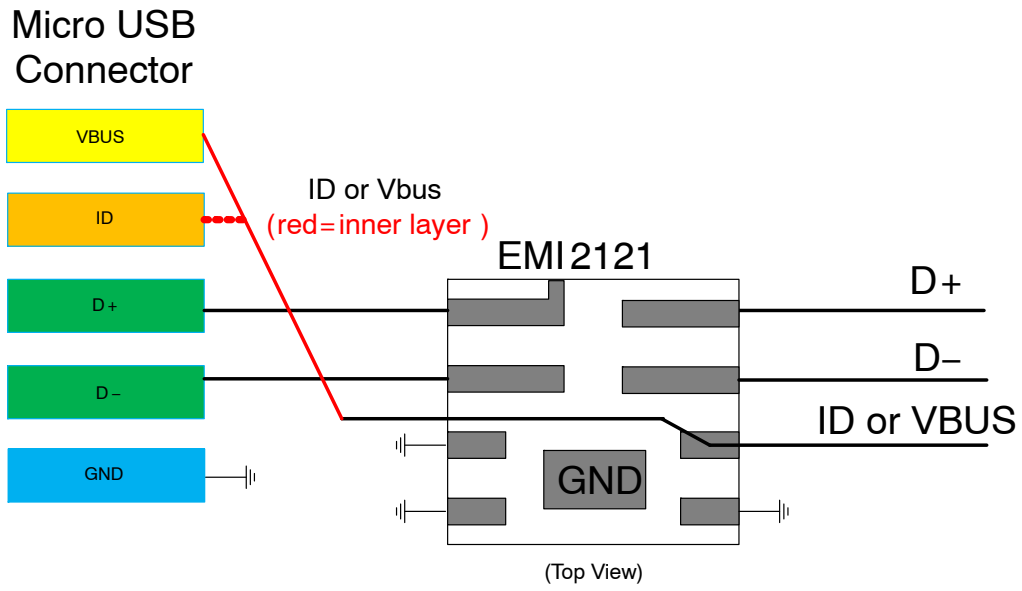
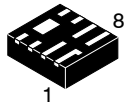

Figure 15. EMI2121 Micro – USB Connector Application Diagram

MECHANICAL CASE OUTLINE

PACKAGE DIMENSIONS

ON Semiconductor®



SCALE 4:1

WDFN8, 2.2x2, 0.5P CASE 511BN ISSUE A

DATE 11 DEC 2012

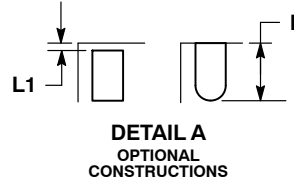
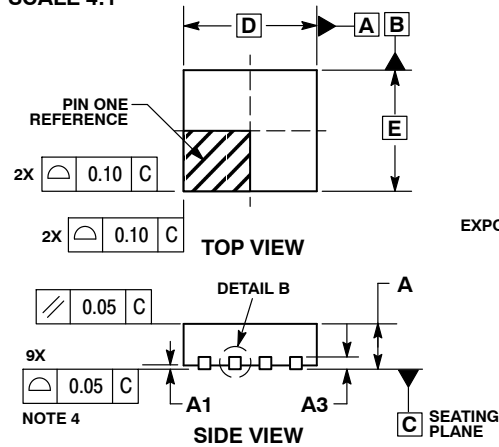

- NOTES:
1. DIMENSIONING AND TOLERANCING PER ASME Y14.5M, 1994.
 2. CONTROLLING DIMENSION: MILLIMETERS.
 3. DIMENSION b APPLIES TO PLATED TERMINAL AND IS MEASURED BETWEEN 0.15 AND 0.25 mm FROM TERMINAL.
 4. COPLANARITY APPLIES TO THE EXPOSED PAD AS WELL AS THE TERMINALS.

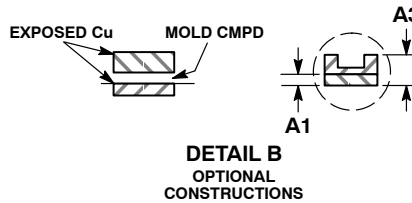

MILLIMETERS		
DIM	MIN	MAX
A	0.70	0.80
A1	0.00	0.05
A3	0.20	REF
b	0.15	0.25
b1	0.25	0.35
D	2.20	BSC
D2	0.34	0.54
E	2.00	BSC
E2	0.60	0.80
e	0.50	BSC
L	0.75	0.95
L1	0.05	0.15
L2	0.30	0.50
L3	0.15	0.25

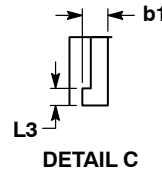
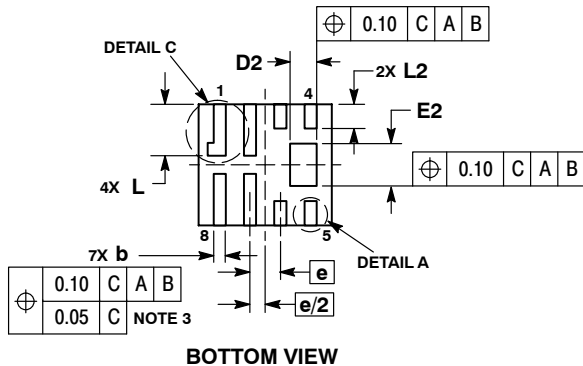

GENERIC MARKING DIAGRAM*

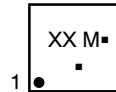

- XX = Specific Device Code
- M = Date Code
- = Pb-Free Device

*This information is generic. Please refer to device data sheet for actual part marking.
Pb-Free indicator, "G" or microdot "■", may or may not be present.

RECOMMENDED SOLDERING FOOTPRINT*

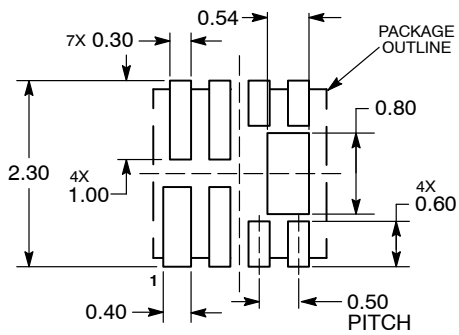

DIMENSIONS: MILLIMETERS

*For additional information on our Pb-Free strategy and soldering details, please download the ON Semiconductor Soldering and Mounting Techniques Reference Manual, SOLDERRM/D.

DOCUMENT NUMBER:	98AON52381E	Electronic versions are uncontrolled except when accessed directly from the Document Repository. Printed versions are uncontrolled except when stamped "CONTROLLED COPY" in red.
DESCRIPTION:	WDFN8, 2.2X2.0, 0.5P	PAGE 1 OF 1

ON Semiconductor and ON are trademarks of Semiconductor Components Industries, LLC dba ON Semiconductor or its subsidiaries in the United States and/or other countries. ON Semiconductor reserves the right to make changes without further notice to any products herein. ON Semiconductor makes no warranty, representation or guarantee regarding the suitability of its products for any particular purpose, nor does ON Semiconductor assume any liability arising out of the application or use of any product or circuit, and specifically disclaims any and all liability, including without limitation special, consequential or incidental damages. ON Semiconductor does not convey any license under its patent rights nor the rights of others.

onsemi, **Onsemi**, and other names, marks, and brands are registered and/or common law trademarks of Semiconductor Components Industries, LLC dba "**onsemi**" or its affiliates and/or subsidiaries in the United States and/or other countries. **onsemi** owns the rights to a number of patents, trademarks, copyrights, trade secrets, and other intellectual property. A listing of **onsemi**'s product/patent coverage may be accessed at www.onsemi.com/site/pdf/Patent-Marking.pdf. **onsemi** reserves the right to make changes at any time to any products or information herein, without notice. The information herein is provided "as-is" and **onsemi** makes no warranty, representation or guarantee regarding the accuracy of the information, product features, availability, functionality, or suitability of its products for any particular purpose, nor does **onsemi** assume any liability arising out of the application or use of any product or circuit, and specifically disclaims any and all liability, including without limitation special, consequential or incidental damages. Buyer is responsible for its products and applications using **onsemi** products, including compliance with all laws, regulations and safety requirements or standards, regardless of any support or applications information provided by **onsemi**. "Typical" parameters which may be provided in **onsemi** data sheets and/or specifications can and do vary in different applications and actual performance may vary over time. All operating parameters, including "Typicals" must be validated for each customer application by customer's technical experts. **onsemi** does not convey any license under any of its intellectual property rights nor the rights of others. **onsemi** products are not designed, intended, or authorized for use as a critical component in life support systems or any FDA Class 3 medical devices or medical devices with a same or similar classification in a foreign jurisdiction or any devices intended for implantation in the human body. Should Buyer purchase or use **onsemi** products for any such unintended or unauthorized application, Buyer shall indemnify and hold **onsemi** and its officers, employees, subsidiaries, affiliates, and distributors harmless against all claims, costs, damages, and expenses, and reasonable attorney fees arising out of, directly or indirectly, any claim of personal injury or death associated with such unintended or unauthorized use, even if such claim alleges that **onsemi** was negligent regarding the design or manufacture of the part. **onsemi** is an Equal Opportunity/Affirmative Action Employer. This literature is subject to all applicable copyright laws and is not for resale in any manner.

ADDITIONAL INFORMATION

TECHNICAL PUBLICATIONS:

Technical Library: www.onsemi.com/design/resources/technical-documentation
onsemi Website: www.onsemi.com

ONLINE SUPPORT: www.onsemi.com/support

For additional information, please contact your local Sales Representative at www.onsemi.com/support/sales