

# High-Side and Low-Side Gate Driver

## FAN7382

The FAN7382, a monolithic high and low side gate-drive IC, can drive MOSFETs and IGBTs that operate up to +600 V. onsemi's high-voltage process and commonmode noise canceling technique provides stable operation of the high-side driver under high-dv/dt noise circumstances. An advanced level-shift circuit allows high-side gate driver operation up to  $V_S = -9.8$  V (typical) for  $V_{BS} = 15$  V. The input logic level is compatible with standard TTL-series logic gates. UVLO circuits for both channels prevent malfunction when  $V_{CC}$  or  $V_{BS}$  is lower than the specified threshold voltage. Output drivers typically source/sink 350 mA/650 mA, respectively, which is suitable for fluorescent lamp ballasts, PDP scan drivers, motor controls, etc.

### Features

- Floating Channels Designed for Bootstrap Operation to +600 V
- Typically 350 mA/650 mA Sourcing/Sinking Current Driving Capability for Both Channels
- Common-Mode dv/dt Noise Canceling Circuit
- Extended Allowable Negative  $V_S$  Swing to -9.8 V for Signal Propagation at  $V_{CC} = V_{BS} = 15$  V
- $V_{CC}$  &  $V_{BS}$  Supply Range from 10 V to 20 V
- UVLO Functions for Both Channels
- TTL Compatible Input Logic Threshold Levels
- Matched Propagation Delay Below 50 ns
- Output In-phase with Input Signal
- These are Pb-Free Devices

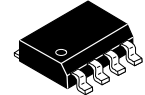

SOIC8  
CASE 751EG

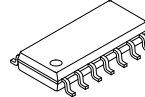

SOIC14 N  
CASE 751ER

### MARKING DIAGRAMS

#### SOIC8

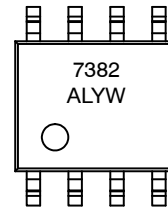

7382 = Device Code  
 A = Assembly Site  
 L = Wafer Lot Number  
 YW = Assembly Start Week

#### SOIC14 N

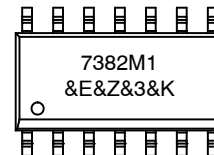

7382M1 = Device Code  
 &E = Designates Space  
 &Z = Assembly Location  
 &3 = 3-Digit Date Code  
 &K = 2-Digits Lot Run Traceability Code

### ORDERING INFORMATION

See detailed ordering and shipping information on page 12 of this data sheet.



# FAN7382

## Pin Assignments

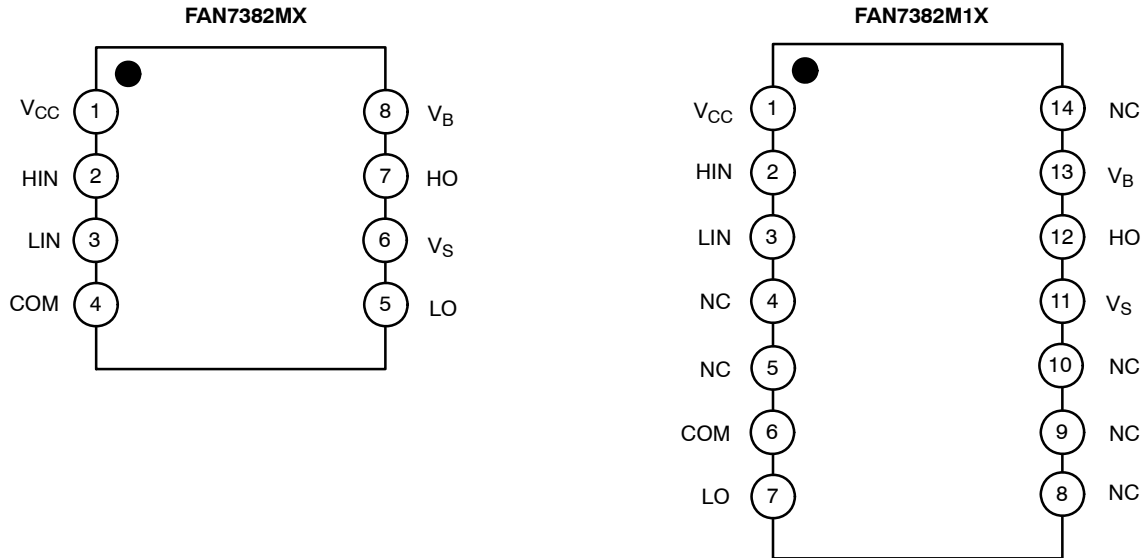

Figure 3. Pin Configuration (Top View)

## PIN DEFINITIONS

Name	Description
V <sub>CC</sub>	Low-Side Supply Voltage
HIN	Logic Input for High-Side Gate Driver Output
LIN	Logic Input for Low-Side Gate Driver Output
COM	Logic Ground and Low-Side Driver Return
LO	Low-Side Driver Output
V <sub>S</sub>	High-Voltage Floating Supply Return
HO	High-Side Driver Output
V <sub>B</sub>	High-Side Floating Supply

**ABSOLUTE MAXIMUM RATINGS**

Parameter	Symbol	Min	Max	Unit
High-Side Offset Voltage	$V_S$	$V_B - 25$	$V_B + 0.3$	V
High-Side Floating Supply Voltage	$V_B$	-0.3	625	
High-Side Floating Output Voltage HO	$V_{HO}$	$V_S - 0.3$	$V_B + 0.3$	
Low-Side and Logic Fixed Supply Voltage	$V_{CC}$	-0.3	25	
Low-Side Output Voltage LO	$V_{LO}$	-0.3	$V_{CC} + 0.3$	
Logic Input Voltage (HIN, LIN)	$V_{IN}$	-0.3	$V_{CC} + 0.3$	
Logic Ground	COM	$V_{CC} - 25$	$V_{CC} + 0.3$	
Allowable Offset Voltage Slew Rate	$dV_S/dt$		50	V/ns
Power Dissipation	$P_D$ (Notes 1, 2, 3)	SOIC8	0.625	W
		SOIC14 N	1.0	
Junction temperature	$T_J$		150	°C
Storage Temperature	$T_{STG}$		150	°C

Stresses exceeding those listed in the Maximum Ratings table may damage the device. If any of these limits are exceeded, device functionality should not be assumed, damage may occur and reliability may be affected.

1. Mounted on 76.2 x 114.3 x 1.6 mm PCB (FR-4 glass epoxy material).
2. Refer to the following standards:  
 JESD51-2: Integral circuits thermal test method environmental conditions – natural convection  
 JESD51-3: Low effective thermal conductivity test board for leaded surface mount packages
3. Do not exceed  $P_D$  under any circumstances.

**THERMAL CHARACTERISTICS**

Parameter	Symbol	Min	Max	Unit
Thermal Resistance, Junction-to-Ambient	$\theta_{JA}$	SOIC8	200	°C/W
		SOIC14 N	110	

**RECOMMENDED OPERATING CONDITIONS**

Parameter	Symbol	Min	Max	Unit
High-Side Floating Supply Voltage	$V_B$	$V_S + 10$	$V_S + 20$	V
High-Side Floating Supply Offset Voltage	$V_S$	$6 - V_{CC}$	600	V
High-Side (HO) Output Voltage	$V_{HO}$	$V_S$	$V_B$	V
Low-Side (LO) Output Voltage	$V_{LO}$	COM	$V_{CC}$	V
Logic Input Voltage (HIN, LIN)	$V_{IN}$	COM	$V_{CC}$	V
Low-Side Supply Voltage	$V_{CC}$	10	20	V
Ambient Temperature	$T_A$	-40	125	°C

Functional operation above the stresses listed in the Recommended Operating Ranges is not implied. Extended exposure to stresses beyond the Recommended Operating Ranges limits may affect device reliability.

# FAN7382

## ELECTRICAL CHARACTERISTICS

$V_{BIAS}$  ( $V_{CC}$ ,  $V_{BS}$ ) = 15.0 V,  $T_A$  = 25°C, unless otherwise specified. The  $V_{IN}$  and  $I_{IN}$  parameters are referenced to COM. The  $V_O$  and  $I_O$  parameters are referenced to  $V_S$  and COM and are applicable to the respective outputs HO and LO.

Parameter	Test Condition	Symbol	Min	Typ	Max	Unit
$V_{CC}$ and $V_{BS}$ Supply Under-Voltage Positive Going Threshold		$V_{CCUV+}$ $V_{BSUV+}$	8.2	9.2	10.0	V
$V_{CC}$ and $V_{BS}$ Supply Under-Voltage Negative Going Threshold		$V_{CCUV-}$ $V_{BSUV-}$	7.6	8.7	9.6	V
$V_{CC}$ Supply Under-Voltage Lockout Hysteresis		$V_{CCUVH}$ $V_{BSUVH}$		0.6		V
Offset Supply Leakage Current	$V_B = V_S = 600$ V	$I_{LK}$			50	$\mu$ A
Quiescent $V_{BS}$ Supply Current	$V_{IN} = 0$ V or 5 V	$I_{QBS}$		45	120	$\mu$ A
Quiescent $V_{CC}$ Supply Current	$V_{IN} = 0$ V or 5 V	$I_{QCC}$		70	180	$\mu$ A
Operating $V_{BS}$ Supply Current	$f_{IN} = 20$ kHz, rms value	$I_{PBS}$			600	$\mu$ A
Operating $V_{CC}$ Supply Current	$f_{IN} = 20$ kHz, rms value	$I_{PCC}$			600	$\mu$ A
Logic "1" Input Voltage		$V_{IH}$	2.9			V
Logic "0" input voltage		$V_{IL}$			0.8	V
High-Level Output Voltage, $V_{BIAS} - V_O$	$I_O = 20$ mA	$V_{OH}$			1.0	V
Low-Level Output Voltage, $V_O$		$V_{OL}$			0.6	V
Logic "1" Input Bias Current	$V_{IN} = 5$ V	$I_{IN+}$		10	20	$\mu$ A
Logic "0" Input Bias Current	$V_{IN} = 0$ V	$I_{IN-}$		1.0	2.0	$\mu$ A
Output High Short-Circuit Pulsed Current	$V_O = 0$ V, $V_{IN} = 5$ V with $PW < 10$ $\mu$ s	$I_{O+}$	250	350		mA
Output Low Short-Circuit Pulsed Current	$V_O = 15$ V, $V_{IN} = 0$ V with $PW < 10$ $\mu$ s	$I_{O-}$	500	650		mA
Allowable Negative $V_S$ Pin Voltage for $H_{IN}$ Signal Propagation to HO		$V_S$		-9.8	-7.0	V

Product parametric performance is indicated in the Electrical Characteristics for the listed test conditions, unless otherwise noted. Product performance may not be indicated by the Electrical Characteristics if operated under different conditions.

Product parametric performance is indicated in the Electrical Characteristics for the listed test conditions, unless otherwise noted. Product performance may not be indicated by the Electrical Characteristics if operated under different conditions.

## DYNAMIC ELECTRICAL CHARACTERISTICS

$V_{BIAS}$  ( $V_{CC}$ ,  $V_{BS}$ ) = 15.0 V,  $V_S = COM$ ,  $C_L = 1000$  pF and,  $T_A = 25^\circ C$ , unless otherwise specified.

Parameter	Test Condition	Symbol	Min	Typ	Max	Unit
Turn-On Propagation Delay	$V_S = 0$ V	$t_{on}$	100	170	300	ns
Turn-Off Propagation Delay	$V_S = 0$ V or 600 V (Note 4)	$t_{off}$	100	200	300	ns
Turn-On Rise Time		$t_r$	20	60	140	ns
Turn-Off Fall Time		$t_f$		30	80	ns
Delay Matching, HS & LS Turn-On/Off		MT			50	ns

4. This parameter guaranteed by design.

TYPICAL CHARACTERISTICS

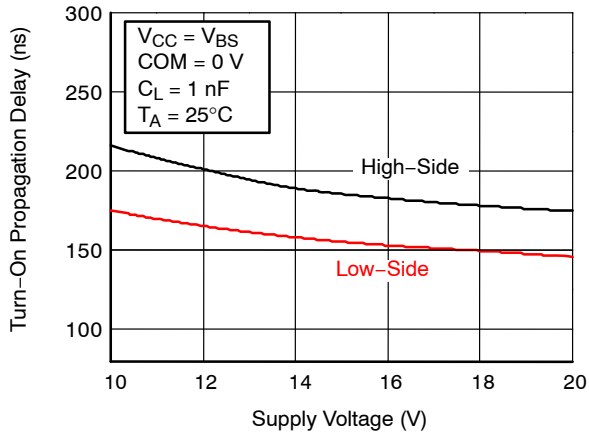

Figure 4. Turn-On Propagation Delay vs. Supply Voltage

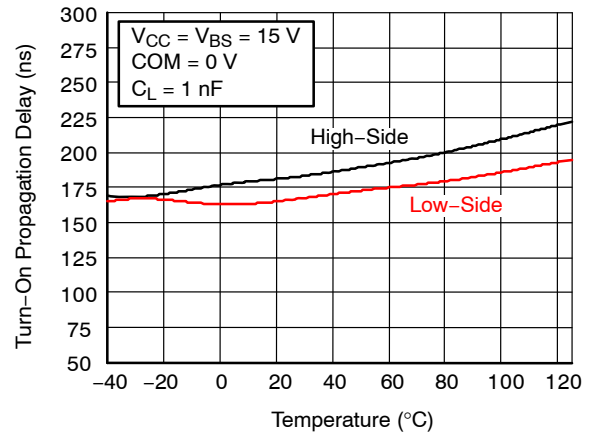

Figure 5. Turn-On Propagation Delay vs. Temperature

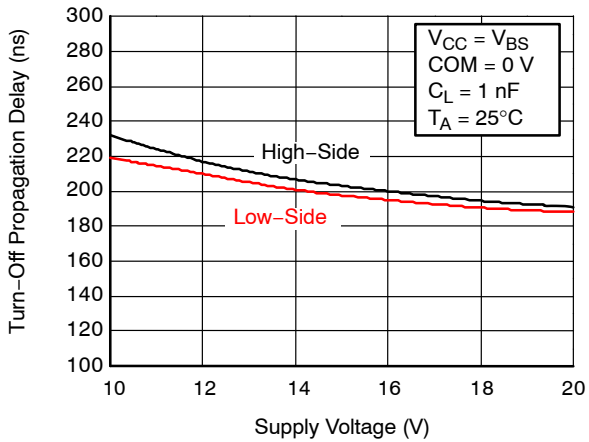

Figure 6. Turn-Off Propagation Delay vs. Supply Voltage

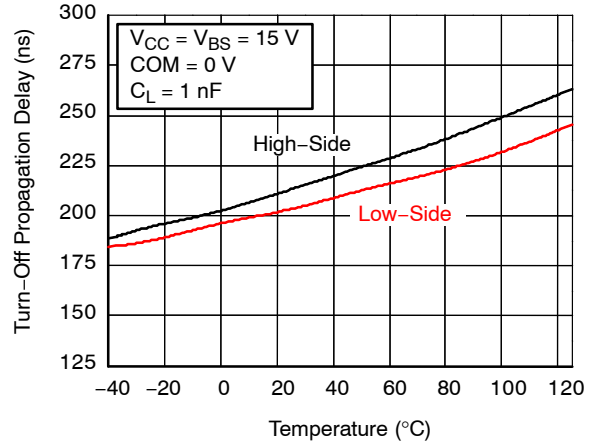

Figure 7. Turn-Off Propagation Delay vs. Temperature

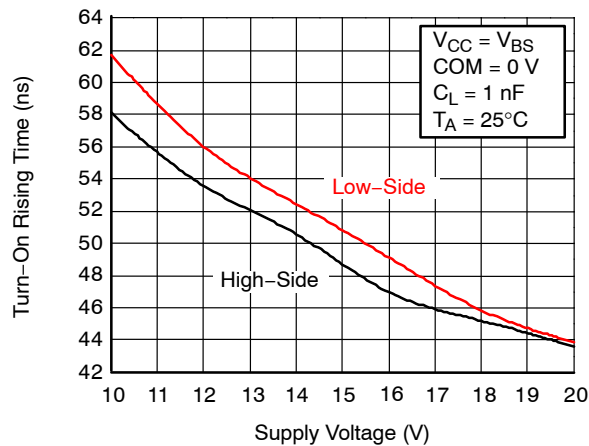

Figure 8. Turn-On Rising Time vs. Supply Voltage

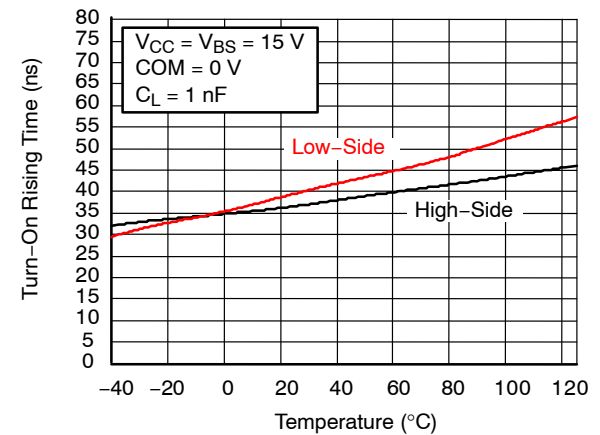

Figure 9. Turn-On Rising Time vs. Temperature

TYPICAL CHARACTERISTICS (continued)

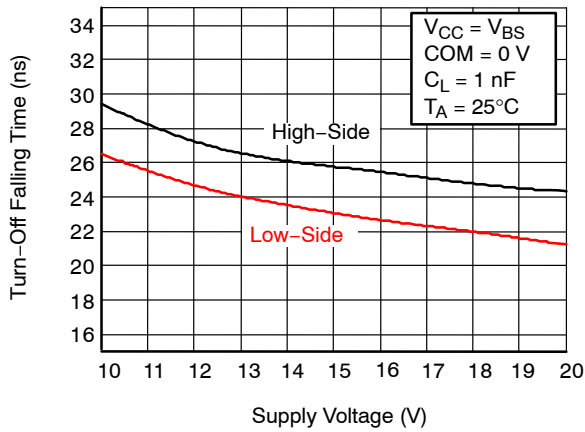

Figure 10. Turn-Off Falling Time vs. Supply Voltage

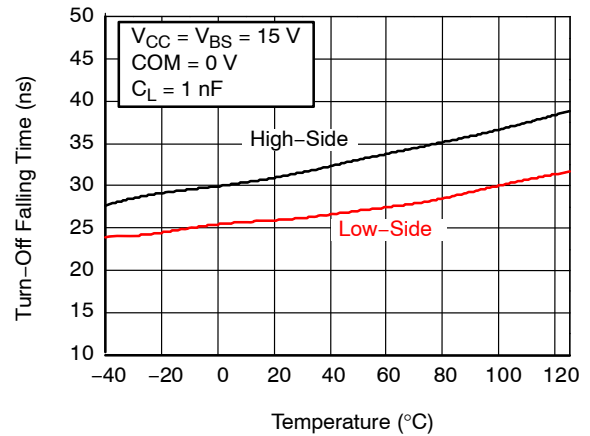

Figure 11. Turn-Off Falling Time vs. Temperature

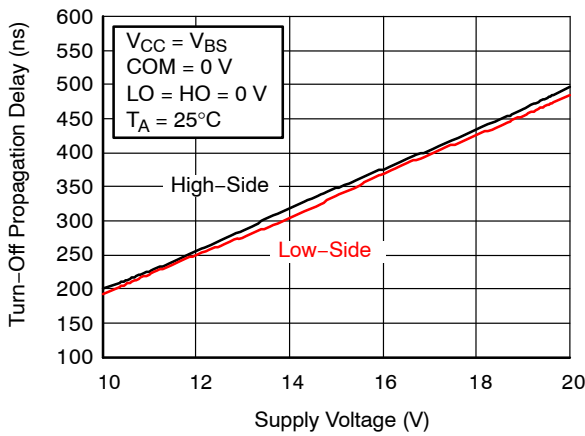

Figure 12. Output Sourcing Current vs. Supply Voltage

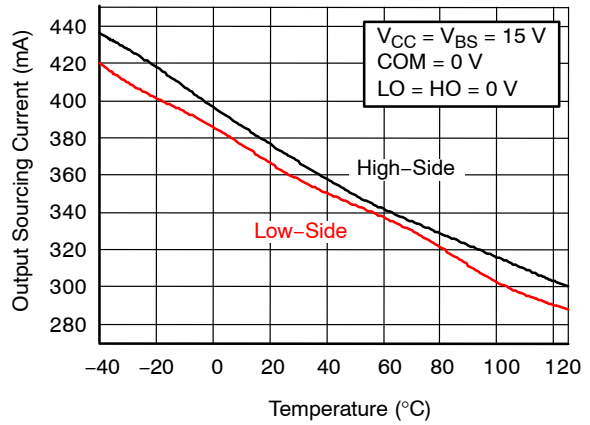

Figure 13. Output Sourcing Current vs. Temperature

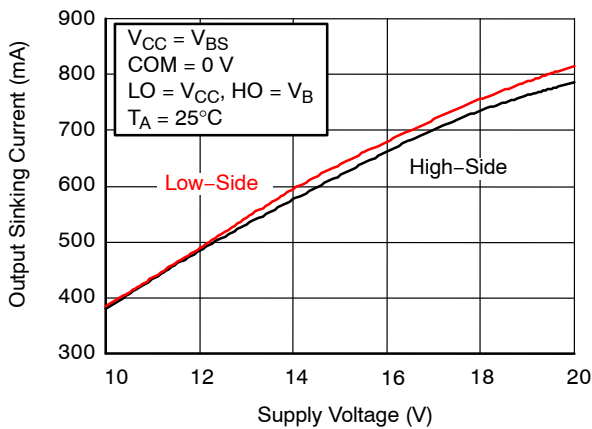

Figure 14. Output Sinking Current vs. Supply Voltage

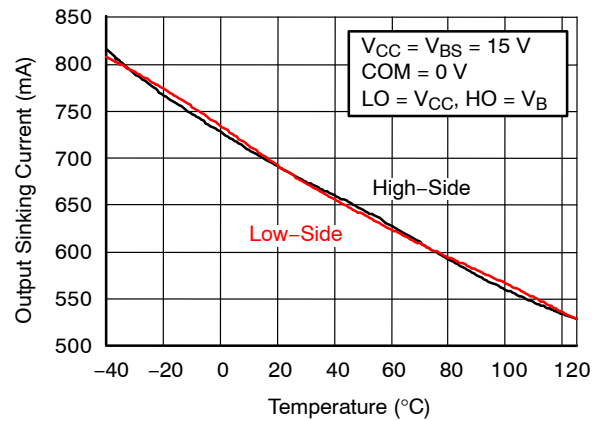

Figure 15. Output Sinking Current vs. Temperature

TYPICAL CHARACTERISTICS (continued)

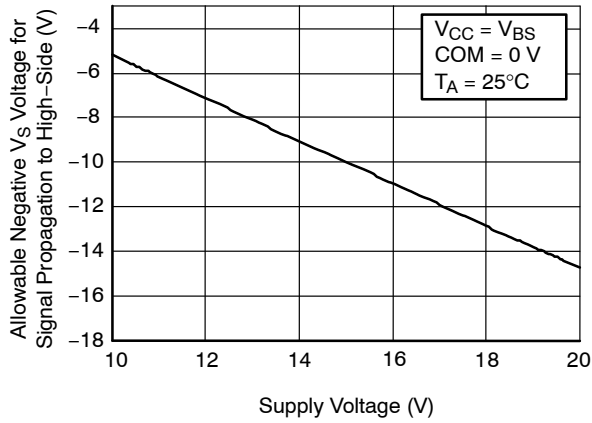

Figure 16. Allowable Negative  $V_S$  Voltage for Signal Propagation to High Side vs. Supply Voltage

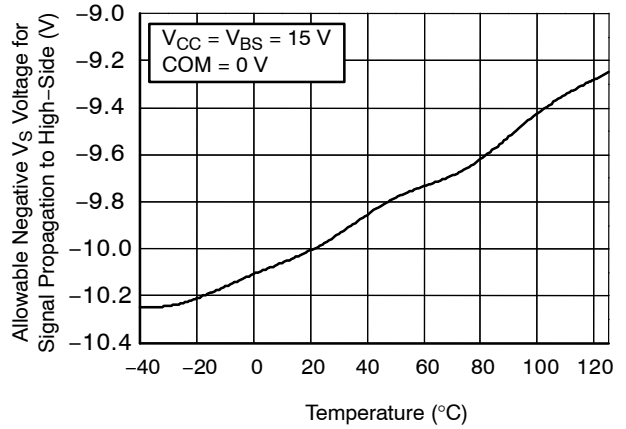

Figure 17. Allowable Negative  $V_S$  Voltage for Signal Propagation to High Side vs. Temperature

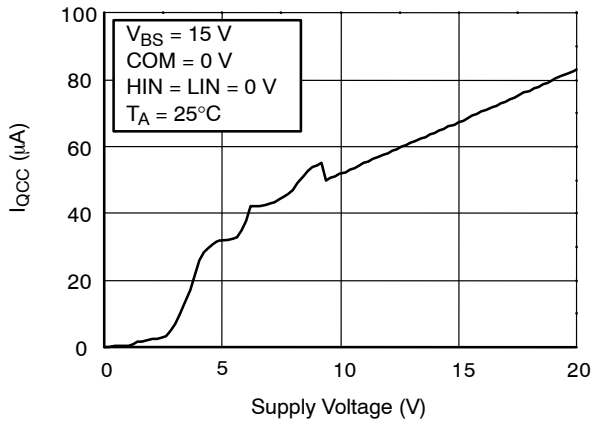

Figure 18.  $I_{QCC}$  vs. Supply Voltage

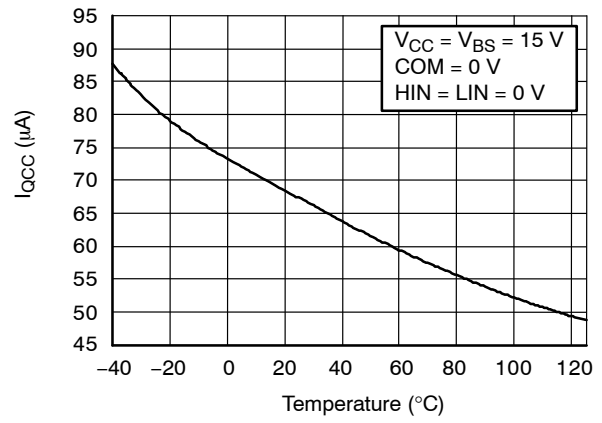

Figure 19.  $I_{QCC}$  vs. Temperature

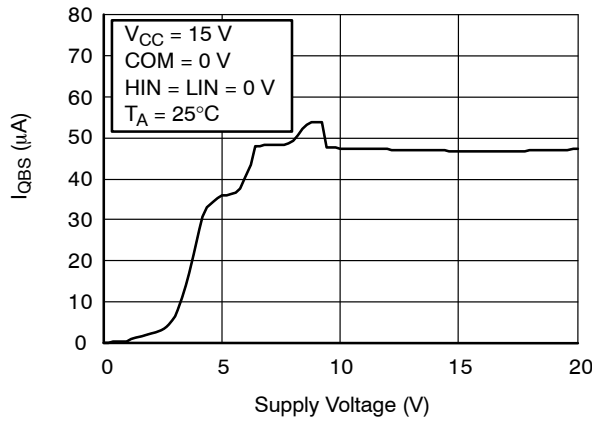

Figure 20.  $I_{QBS}$  vs. Supply Voltage

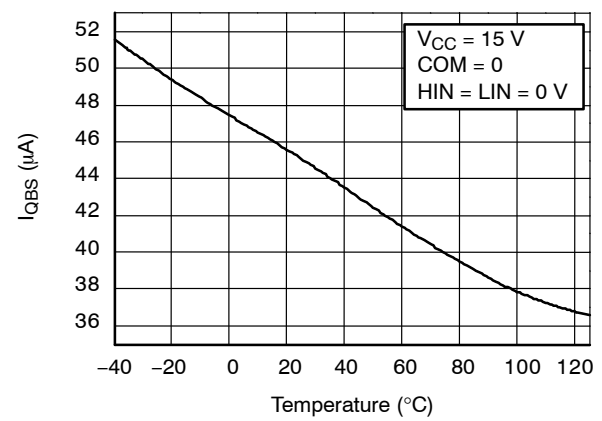

Figure 21.  $I_{QBS}$  vs. Temperature



TYPICAL CHARACTERISTICS (continued)

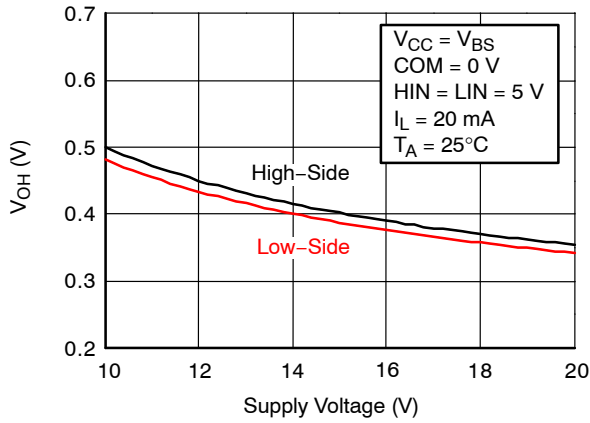

Figure 22. High-Level Output Voltage vs. Supply Voltage

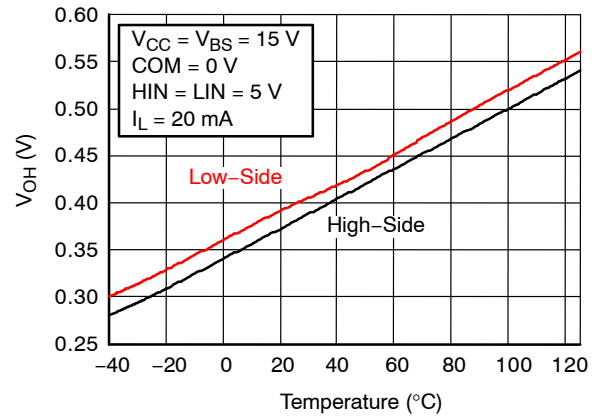

Figure 23. High-Level Output Voltage vs. Temperature

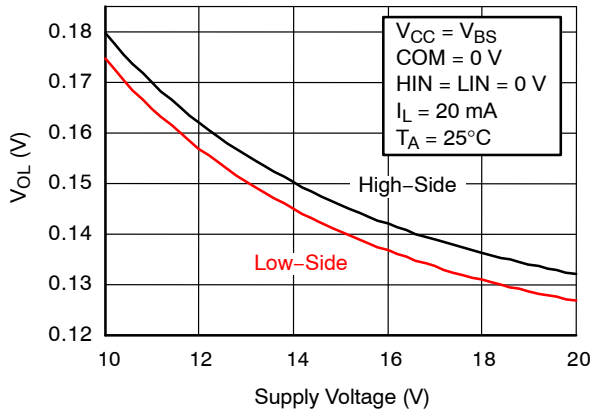

Figure 24. Low-Level Output Voltage vs. Supply Voltage

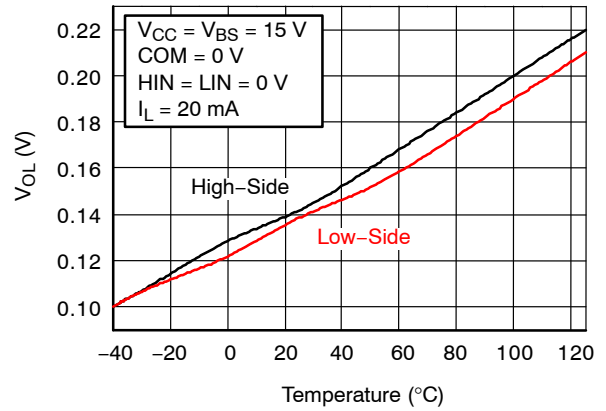

Figure 25. Low-Level Output Voltage vs. Temperature

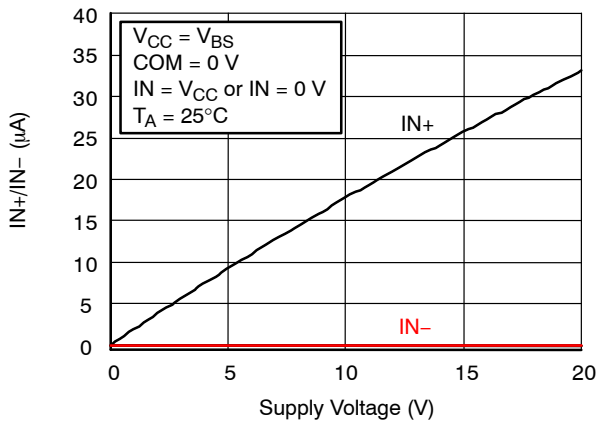

Figure 26. Input Bias Current vs. Supply Voltage

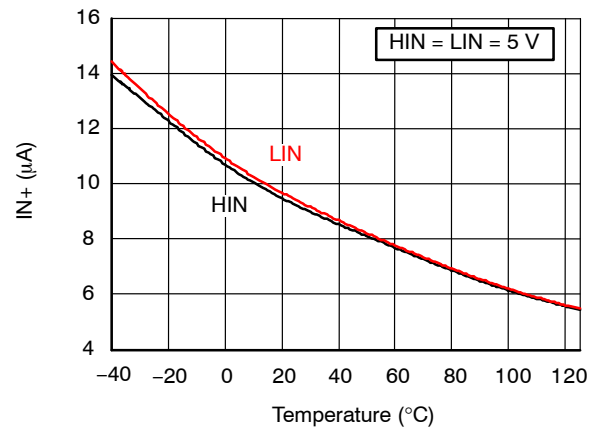

Figure 27. Input Bias Current vs. Temperature

TYPICAL CHARACTERISTICS (continued)

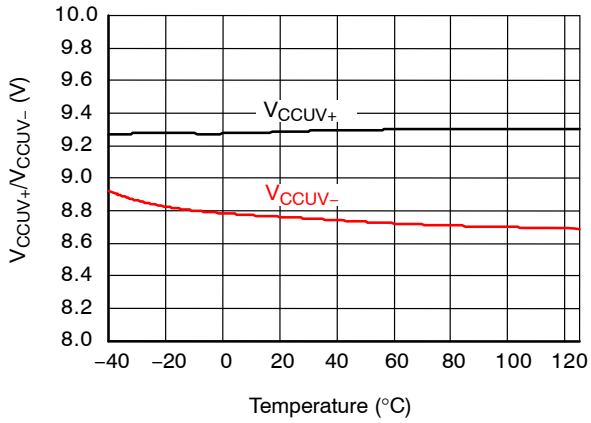

Figure 28. V<sub>CC</sub> UVLO Threshold Voltage vs. Temperature

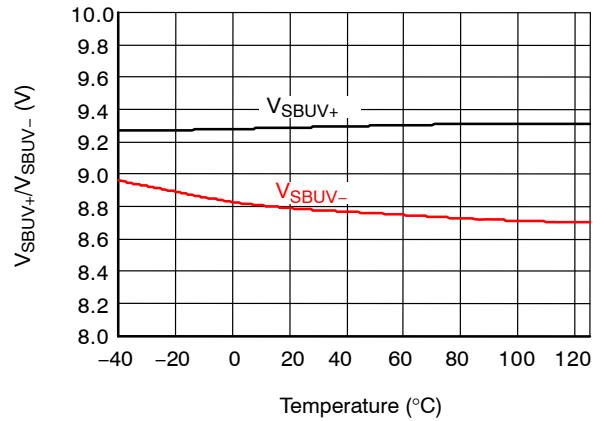

Figure 29. V<sub>BS</sub> UVLO Threshold Voltage vs. Temperature

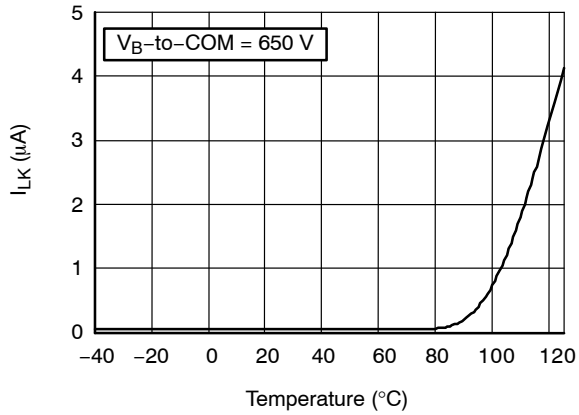

Figure 30. V<sub>B</sub> to COM Leakage Current vs. Temperature

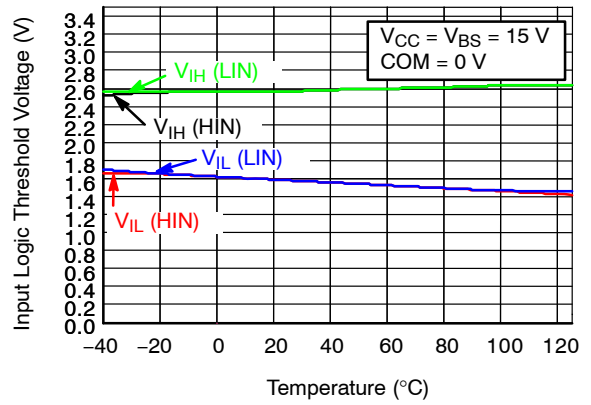

Figure 31. Input Logic Threshold Voltage vs. Temperature

TYPICAL CHARACTERISTICS (continued)

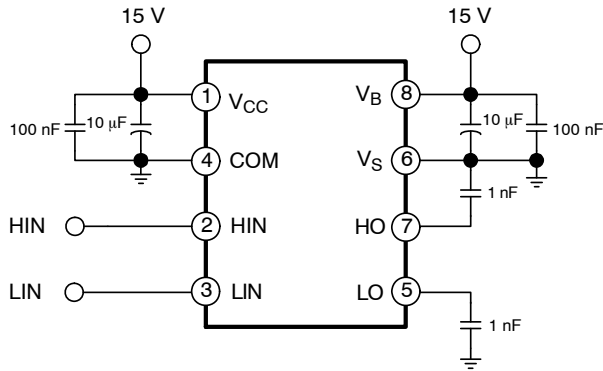

Figure 32. Switching Time Test Circuit

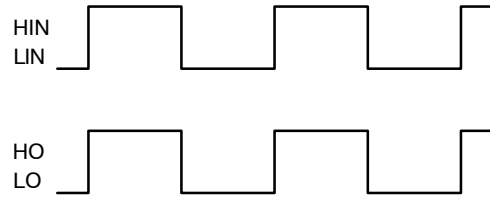

Figure 33. Input / Output Timing Diagram

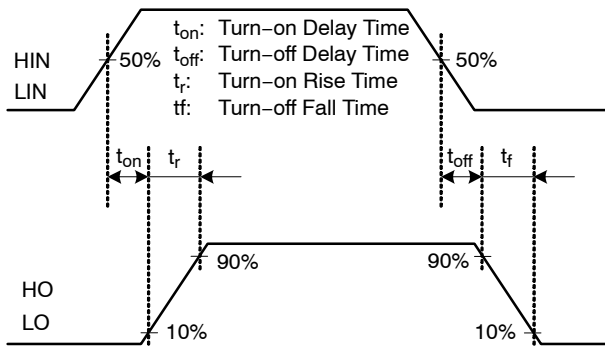

Figure 34. Switching Time Waveform Definition

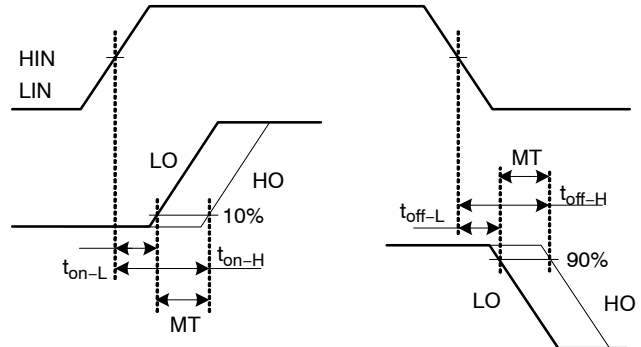

Figure 35. Delay Matching Waveform Definition

# FAN7382

## ORDERING INFORMATION

Part Number	Operating Temperature Range	Package	Shipping <sup>†</sup>
FAN7382MX (Note 5)	-40°C ~125°C	SOIC8 (Pb-Free)	3000 / Tape & Reel
FAN7382M1X (Note 5)		SOIC14 N (Pb-Free)	3000 / Tape & Reel

<sup>†</sup>For information on tape and reel specifications, including part orientation and tape sizes, please refer to our Tape and Reel Packaging Specifications Brochure, BRD8011/D.

5. These devices passed wave soldering test by JESD22A-111.

**MECHANICAL CASE OUTLINE**  
**PACKAGE DIMENSIONS**

ON Semiconductor®



**SOIC8**  
**CASE 751EG**  
**ISSUE O**

DATE 30 SEP 2016

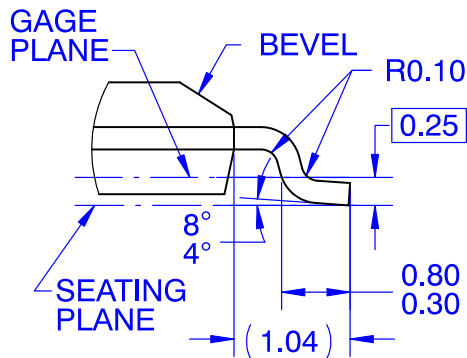
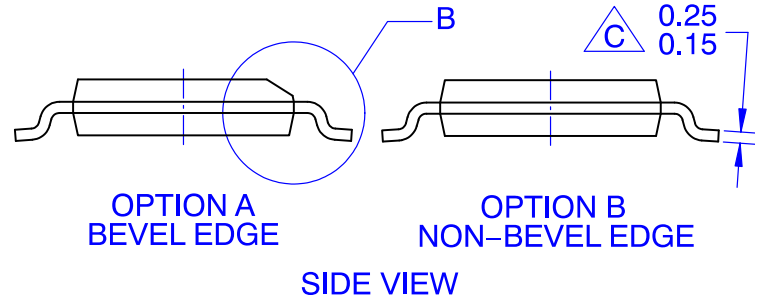
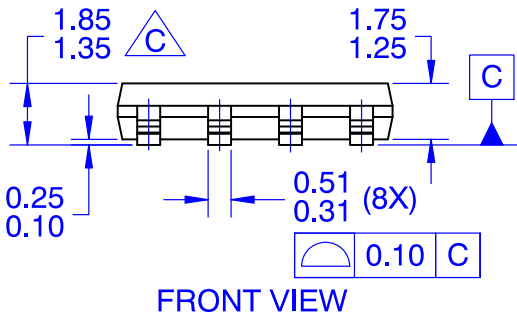
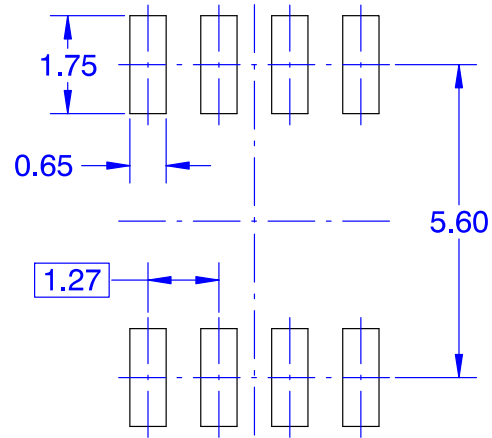
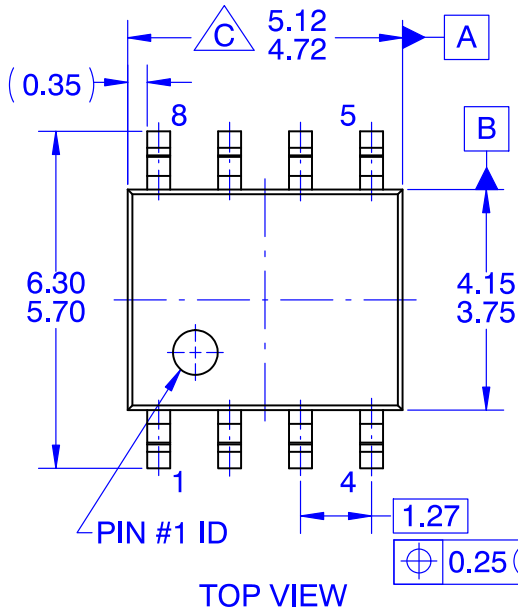

**NOTES: UNLESS OTHERWISE SPECIFIED**

- A. THIS PACKAGE CONFORMS TO JEDEC MS-012 VARIATION A EXCEPT WHERE NOTED.
- B. ALL DIMENSIONS ARE IN MILLIMETERS
- C. OUT OF JEDEC STANDARD VALUE
- D. DIMENSIONS ARE EXCLUSIVE OF BURRS, MOLD FLASH AND TIE BAR EXTRUSIONS.
- E. LAND PATTERN AS PER IPC SOIC127P600X175-8M

<b>DOCUMENT NUMBER:</b>	<b>98AON13741G</b>	Electronic versions are uncontrolled except when accessed directly from the Document Repository. Printed versions are uncontrolled except when stamped "CONTROLLED COPY" in red.
<b>DESCRIPTION:</b>	<b>SOIC8</b>	<b>PAGE 1 OF 1</b>

ON Semiconductor and are trademarks of Semiconductor Components Industries, LLC dba ON Semiconductor or its subsidiaries in the United States and/or other countries. ON Semiconductor reserves the right to make changes without further notice to any products herein. ON Semiconductor makes no warranty, representation or guarantee regarding the suitability of its products for any particular purpose, nor does ON Semiconductor assume any liability arising out of the application or use of any product or circuit, and specifically disclaims any and all liability, including without limitation special, consequential or incidental damages. ON Semiconductor does not convey any license under its patent rights nor the rights of others.

# MECHANICAL CASE OUTLINE

## PACKAGE DIMENSIONS

ON Semiconductor®



### SOIC14 N CASE 751ER ISSUE O

DATE 31 DEC 2016

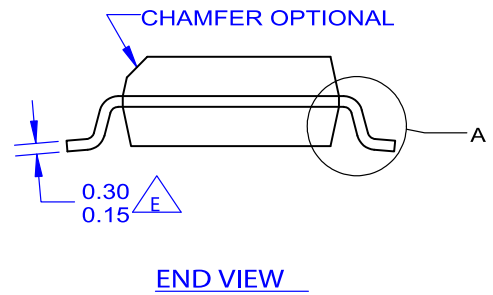
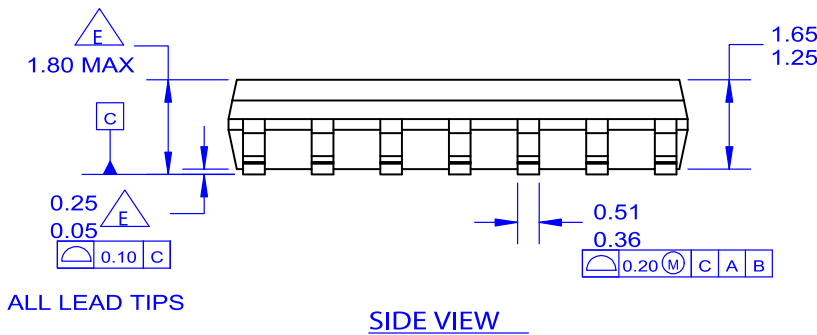
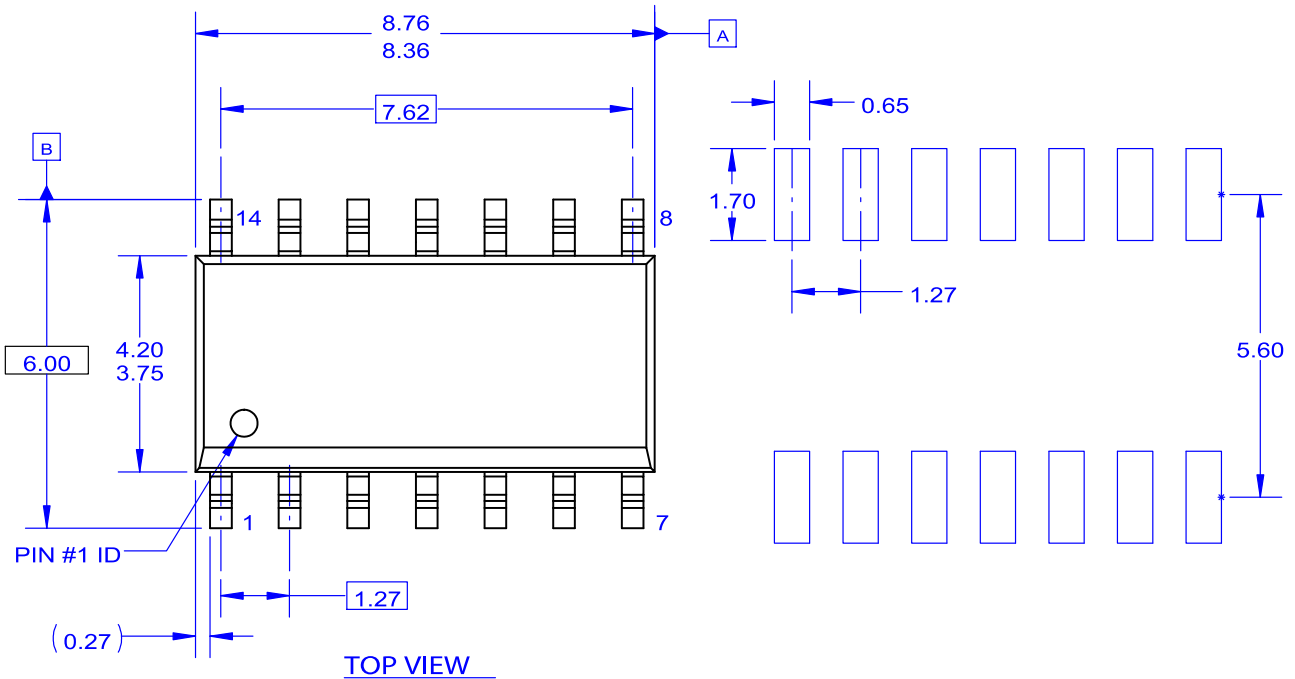

**NOTES: UNLESS OTHERWISE SPECIFIED**

- A. THIS PACKAGE REFERENCE TO JEDEC MS-012 VARIATION AB.
- B. ALL DIMENSIONS ARE IN MILLIMETERS.
- C. DIMENSIONS ARE EXCLUSIVE OF BURRS, MOLD FLASH AND TIE BAR EXTRUSIONS.
- D. DIMENSIONS AND TOLERANCES AS PER ASME Y14.5-1994.
- E. OUT OF JEDEC STANDARD VALUE.

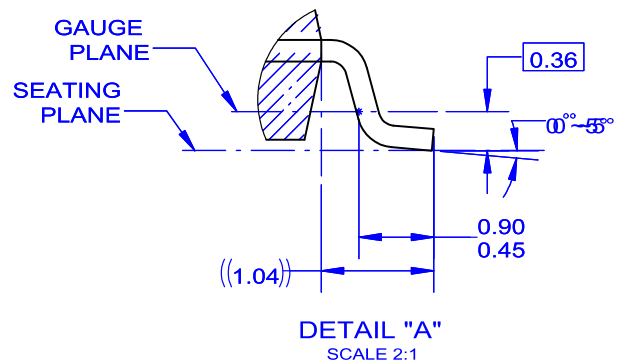

<b>DOCUMENT NUMBER:</b>	<b>98AON13761G</b>	Electronic versions are uncontrolled except when accessed directly from the Document Repository. Printed versions are uncontrolled except when stamped "CONTROLLED COPY" in red.
<b>DESCRIPTION:</b>	<b>SOIC14 N</b>	<b>PAGE 1 OF 1</b>

ON Semiconductor and are trademarks of Semiconductor Components Industries, LLC dba ON Semiconductor or its subsidiaries in the United States and/or other countries. ON Semiconductor reserves the right to make changes without further notice to any products herein. ON Semiconductor makes no warranty, representation or guarantee regarding the suitability of its products for any particular purpose, nor does ON Semiconductor assume any liability arising out of the application or use of any product or circuit, and specifically disclaims any and all liability, including without limitation special, consequential or incidental damages. ON Semiconductor does not convey any license under its patent rights nor the rights of others.

**onsemi**, **Onsemi**, and other names, marks, and brands are registered and/or common law trademarks of Semiconductor Components Industries, LLC dba "**onsemi**" or its affiliates and/or subsidiaries in the United States and/or other countries. **onsemi** owns the rights to a number of patents, trademarks, copyrights, trade secrets, and other intellectual property. A listing of **onsemi**'s product/patent coverage may be accessed at [www.onsemi.com/site/pdf/Patent-Marking.pdf](http://www.onsemi.com/site/pdf/Patent-Marking.pdf). **onsemi** reserves the right to make changes at any time to any products or information herein, without notice. The information herein is provided "as-is" and **onsemi** makes no warranty, representation or guarantee regarding the accuracy of the information, product features, availability, functionality, or suitability of its products for any particular purpose, nor does **onsemi** assume any liability arising out of the application or use of any product or circuit, and specifically disclaims any and all liability, including without limitation special, consequential or incidental damages. Buyer is responsible for its products and applications using **onsemi** products, including compliance with all laws, regulations and safety requirements or standards, regardless of any support or applications information provided by **onsemi**. "Typical" parameters which may be provided in **onsemi** data sheets and/or specifications can and do vary in different applications and actual performance may vary over time. All operating parameters, including "Typicals" must be validated for each customer application by customer's technical experts. **onsemi** does not convey any license under any of its intellectual property rights nor the rights of others. **onsemi** products are not designed, intended, or authorized for use as a critical component in life support systems or any FDA Class 3 medical devices or medical devices with a same or similar classification in a foreign jurisdiction or any devices intended for implantation in the human body. Should Buyer purchase or use **onsemi** products for any such unintended or unauthorized application, Buyer shall indemnify and hold **onsemi** and its officers, employees, subsidiaries, affiliates, and distributors harmless against all claims, costs, damages, and expenses, and reasonable attorney fees arising out of, directly or indirectly, any claim of personal injury or death associated with such unintended or unauthorized use, even if such claim alleges that **onsemi** was negligent regarding the design or manufacture of the part. **onsemi** is an Equal Opportunity/Affirmative Action Employer. This literature is subject to all applicable copyright laws and is not for resale in any manner.

## ADDITIONAL INFORMATION

### TECHNICAL PUBLICATIONS:

Technical Library: [www.onsemi.com/design/resources/technical-documentation](http://www.onsemi.com/design/resources/technical-documentation)  
onsemi Website: [www.onsemi.com](http://www.onsemi.com)

### ONLINE SUPPORT: [www.onsemi.com/support](http://www.onsemi.com/support)

For additional information, please contact your local Sales Representative at [www.onsemi.com/support/sales](http://www.onsemi.com/support/sales)