

REV.	DESCRIPTION	DRAWN	DATE
1	INITIAL RELEASE	Fros	2016/01/12
2	ECR2300003	Fros	2023/04/18
2.1	Corrected, 9.5 was 10.0	Fros	2023/06/16

**SPECIFICATION:**

- ELECTRICAL**
  - Current Rating: 0.5A per pin
  - Voltage Rating: 30V AC/DC
  - Contact Resistance: 30m $\Omega$
  - Insulation Resistance: 1000M $\Omega$
  - Dielectric Withstanding Voltage: 500VAC
- MECHANICAL**
  - Durability: 5000 Cycle
- ENVIRONMENTAL**
  - Operating temperature range: -40 $^{\circ}\text{C}$ ~+85 $^{\circ}\text{C}$
  - Storage temperature range: -40 $^{\circ}\text{C}$ ~+85 $^{\circ}\text{C}$
- SOLDER ABILITY**
  - Recommended IR-Reflow Temperature: 260 $^{\circ}\text{C}$

**SIM CARD PIN OUT**

PIN NO.	DESC	PIN NO.	DESC
C1	VCC	C5	GND
C2	RST	C6	VPP
C3	CLK	C7	I/O

**CARD DETECTION SWITCH**

When the SIM card is not loaded		When the SIM is loaded with led closed	
3	COVER	LCP, UL94V-0, Black	
2	CONTACT	Phosphor Bronze, Gold Flash on contact area, Tin plating on solder tails, Nickel under plating over all	
1	HOUSING	LCP, UL94V-0, Black	

NO.		PART NAME		DESCRIPTION	
UNLESS OTHERWISE SPECIFIED TOLERANCE					
UNIT:	DECIMAL	LINEAR	ANGLES		
	X.	$\pm 0.50$	$\pm 5^{\circ}$		
	X.X	$\pm 0.25$	$\pm 3^{\circ}$		
	X.XX	$\pm 0.12$	$\pm 1^{\circ}$		
www.attend.com.tw					
DRAWN	Fros	2015/10/28	DRAWN NAME:		
CHECKED	Angel	2015/10/28	SIM Card Socket, Hinge Type, 6+2 Pin, G/F, Reel, w/ PEG, w/Switch		
APPROVED	Ken	2015/10/28	PRODUCT NO.	115F-AAA2	
	SCALE	SHEET	SIZE	FILE NAME	
	1.2	1/3	A4	115F-AAA2_B_2.1	



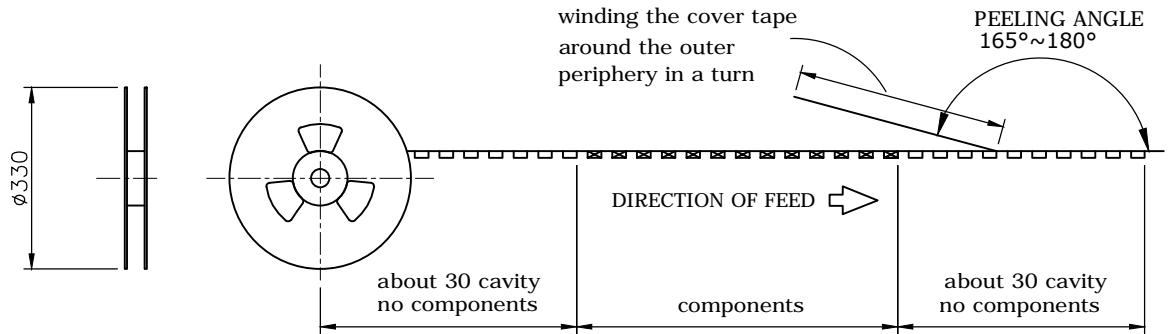

REV.	DESCRIPTION	DRAWN	DATE
------	-------------	-------	------

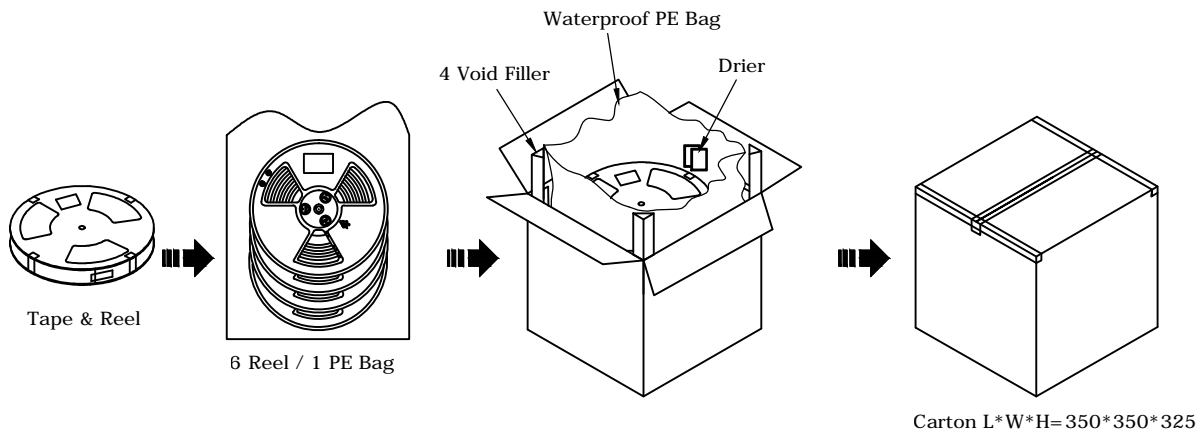
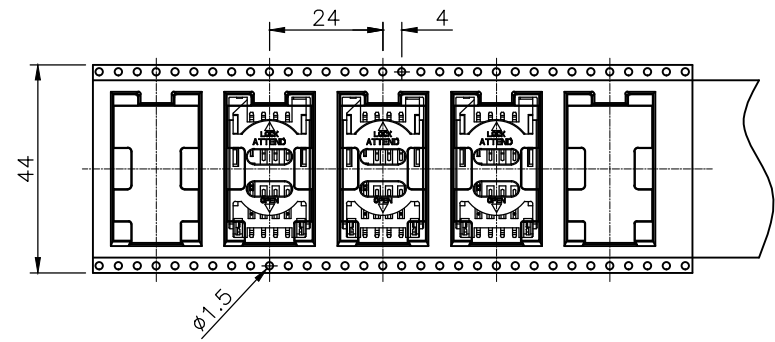

### PACKAGING SPECIFICATION:

1. MATERIAL
  - 1.1 Embossed Carrier Tape: PS Black
  - 1.2 Top Cover Tape: PET  
20-80g(Peel Speed 300mm/Minute)
  - 1.3 Taping Reel: Plastic
2. PACKING
  - 2.1 Quantity:
    - 650 Piece / Reel
    - 6 Reel / Carton
    - 3,900 Piece / Carton



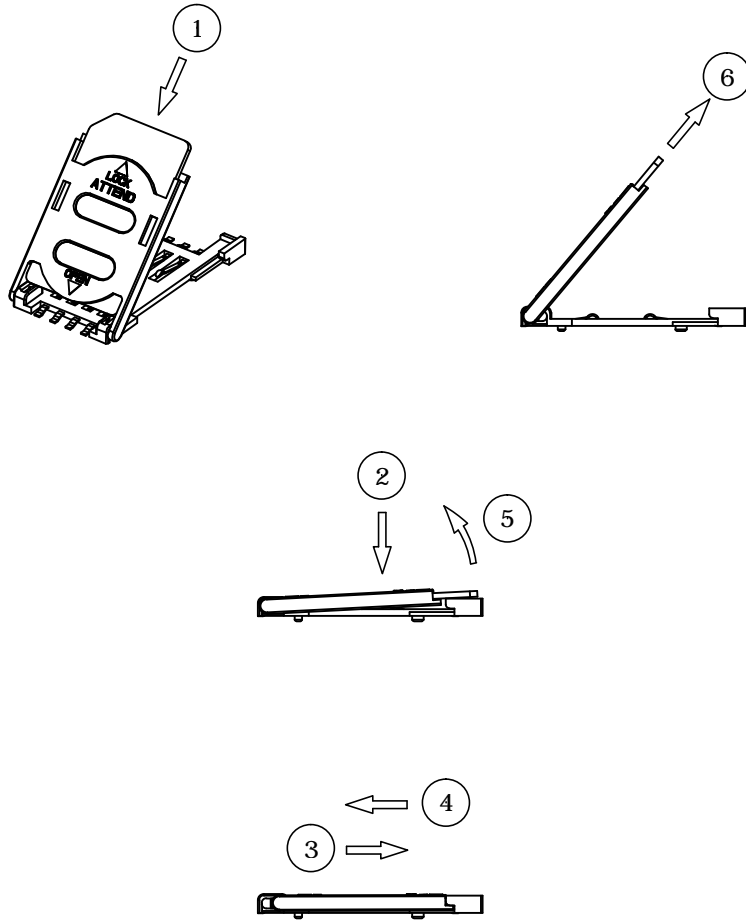

UNLESS OTHERWISE SPECIFIED TOLERANCE				 www.attend.com.tw
UNIT:	DECIMAL	LINEAR	ANGLES	
mm	X.	±0.50	±5°	
	X.X	±0.25	±3°	
	X.XX	±0.12	±1°	
DRAWN	Fros	2015/10/28	DRAWN NAME:	
CHECKED	Angel	2015/10/28	6+2 Pin, G/F, Reel, w/ PEG, w/Switch	
APPROVED	Ken	2015/10/28	PRODUCT NO. 115F-AAA2	
	SCALE n/a	SHEET 2/3	SIZE A4	FILE NAME 115F-AAA2_B_2.1

REV.	DESCRIPTION	DRAWN	DATE



Mating and unmating:

1. Locate the SIM card on the holder
2. Close the holder
3. Press and push forward to lock it.
4. Push backward to unlock it.
5. Lift up the holder.
6. Withdraw the SIM card from the holder.

UNLESS OTHERWISE SPECIFIED TOLERANCE				 www.attend.com.tw	
UNIT:	DECIMAL	LINEAR	ANGLES		
mm	X.	±0.50	±5°		
	X.X	±0.25	±3°		
	X.XX	±0.12	±1°		
DRAWN	Fros	2015/10/28	DRAWN NAME:		
CHECKED	Angel	2015/10/28	SIM Card Socket, Hinge Type, 6+2 Pin, G/F, Reel, w/ PEG, w/Switch		
APPROVED	Ken	2015/10/28	PRODUCT NO.	115F-AAA2	
	SCALE 1.2	SHEET 3/3	SIZE A4	FILE NAME	115F-AAA2_B_2.1