

# PNP Epitaxial Silicon Transistor

## KSA928A

### Features

- Audio Power Amplifier
- Complement to KSC2328A
- 3 W Output Application

### ABSOLUTE MAXIMUM RATINGS

(Values are at  $T_A = 25^\circ\text{C}$  unless otherwise noted.) (Notes 1, 2)

Symbol	Parameter	Value	Unit
$V_{CBO}$	Collector-Base Voltage	-30	V
$V_{CEO}$	Collector-Emitter Voltage	-30	V
$V_{EBO}$	Emitter-Base Voltage	-5	V
$I_C$	Collector Current	-2	A
$T_J$	Junction Temperature	150	$^\circ\text{C}$
$T_{STG}$	Storage Temperature	-55 to +150	$^\circ\text{C}$

Stresses exceeding those listed in the Maximum Ratings table may damage the device. If any of these limits are exceeded, device functionality should not be assumed, damage may occur and reliability may be affected.

1. These ratings are based on a maximum junction temperature of  $150^\circ\text{C}$ .
2. These are steady-state limits. **onsemi** should be consulted on applications involving pulsed or low-duty-cycle operations.

### THERMAL CHARACTERISTICS

(Values are at  $T_A = 25^\circ\text{C}$  unless otherwise noted.) (Note 3)

Symbol	Parameter	Value	Unit
$P_D$	Power Dissipation	1000	mW
	Derate Above $25^\circ\text{C}$	8.0	mW/ $^\circ\text{C}$
$R_{\theta JA}$	Thermal Resistance, Junction-to-Ambient	125	$^\circ\text{C}/\text{W}$

3. PCB size: FR-4, 76 mm  $\times$  114 mm  $\times$  1.57 mm (3.0 inch  $\times$  4.5 inch  $\times$  0.062 inch) with minimum land pattern size.

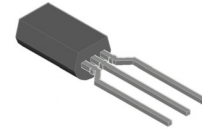

TO-92 3 LF  
CASE 135AM

### MARKING DIAGRAM

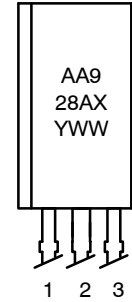

1: Emitter  
2: Collector  
3: Base

A = Assembly Code  
A928A = Device Code  
X = O / Y  
YWW = Date Code

### ORDERING INFORMATION

Device	Package	Shipping
KSA928AOTA	TO-92 3 LF (Pb-Free)	2000 / Fan-Fold
KSA928AYTA	TO-92 3 LF (Pb-Free)	2000 / Fan-Fold

# KSA928A

## ELECTRICAL CHARACTERISTICS

(Values are at  $T_A = 25^\circ\text{C}$  unless otherwise noted.)

Symbol	Parameter	Conditions	Min.	Typ.	Max.	Unit
$BV_{CBO}$	Collector-Base Breakdown Voltage	$I_C = -100 \mu\text{A}, I_E = 0$	-30	-	-	V
$BV_{CEO}$	Collector-Emitter Breakdown Voltage	$I_C = -10 \text{ mA}, I_B = 0$	-30	-	-	V
$BV_{EBO}$	Emitter-Base Breakdown Voltage	$I_E = -1 \text{ mA}, I_C = 0$	-5	-	-	V
$I_{CBO}$	Collector Cut-Off Current	$V_{CB} = -30 \text{ V}, I_E = 0$	-	-	-100	nA
$I_{EBO}$	Emitter Cut-Off Current	$V_{EB} = -5 \text{ V}, I_C = 0$	-	-	-100	nA
$h_{FE}$	DC Current Gain	$V_{CE} = -2 \text{ V}, I_C = -500 \text{ mA}$	100	-	320	
$V_{BE(on)}$	Base-Emitter On Voltage	$V_{CE} = -2 \text{ V}, I_C = -500 \text{ mA}$	-	-	-1.0	V
$V_{CE(sat)}$	Collector-Emitter Saturation Voltage	$I_C = -1.5 \text{ A}, I_B = -30 \text{ mA}$	-	-	-2.0	V
$f_T$	Current Gain Bandwidth Product	$V_{CE} = -2 \text{ V}, I_C = -500 \text{ mA}$	-	120	-	MHz
$C_{ob}$	Collector Output Capacitance	$V_{CB} = -10 \text{ V}, I_E = 0, f = 1 \text{ MHz}$	-	48	-	pF

Product parametric performance is indicated in the Electrical Characteristics for the listed test conditions, unless otherwise noted. Product performance may not be indicated by the Electrical Characteristics if operated under different conditions.

## $h_{FE}$ CLASSIFICATION

Classification	O	Y
$h_{FE}$	100 ~ 200	160 ~ 320

TYPICAL PERFORMANCE CHARACTERISTICS

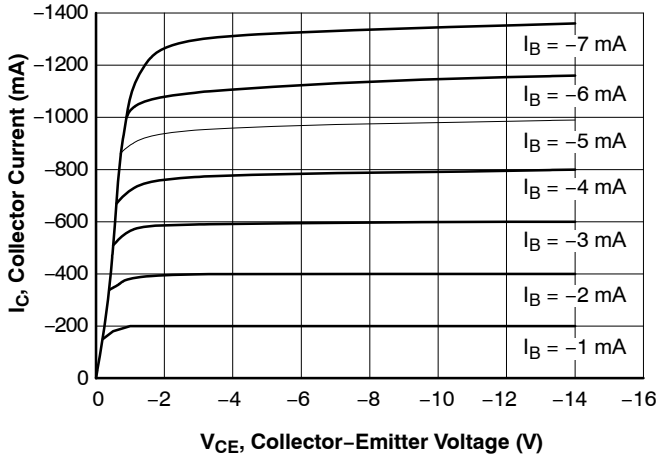

Figure 1. Static Characteristic

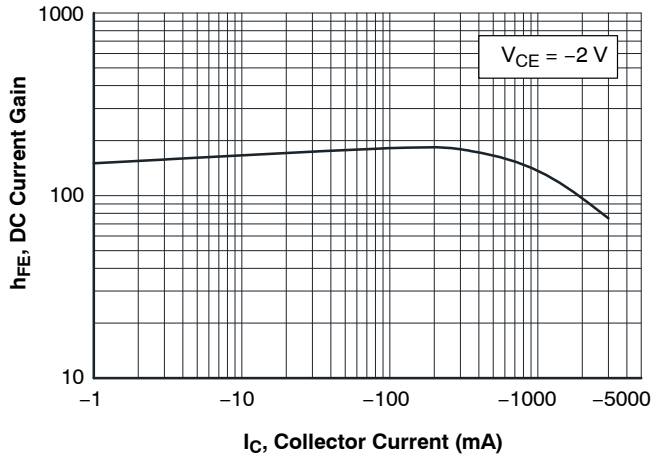

Figure 2. DC Current Gain

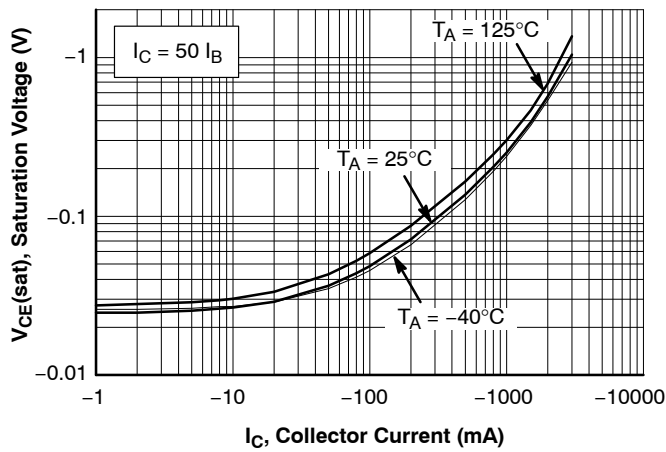

Figure 3. Collector-Emitter Saturation Voltage

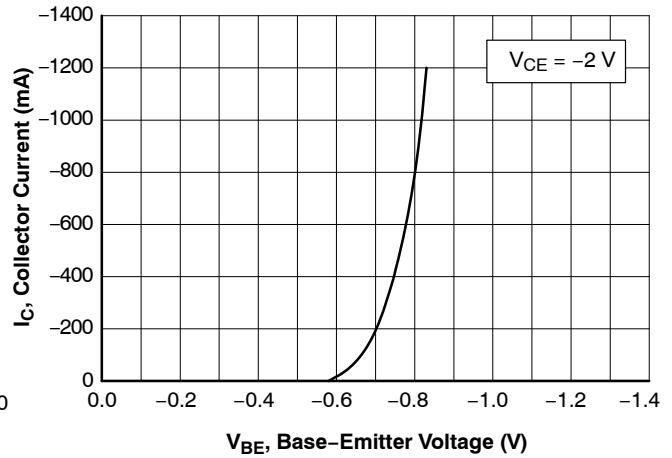

Figure 4. Base-Emitter On Voltage

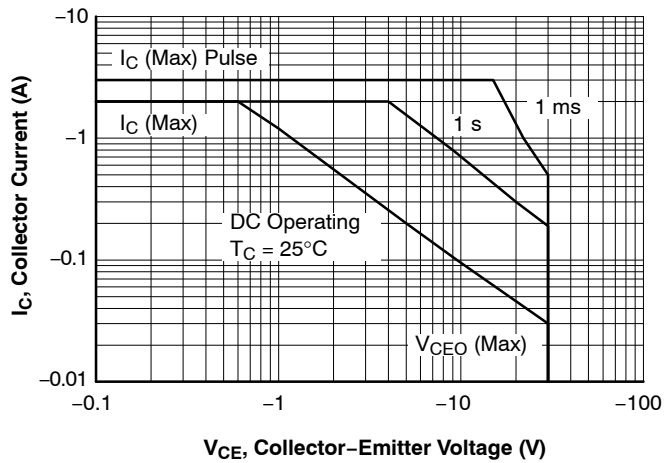

Figure 5. Safe Operating Area

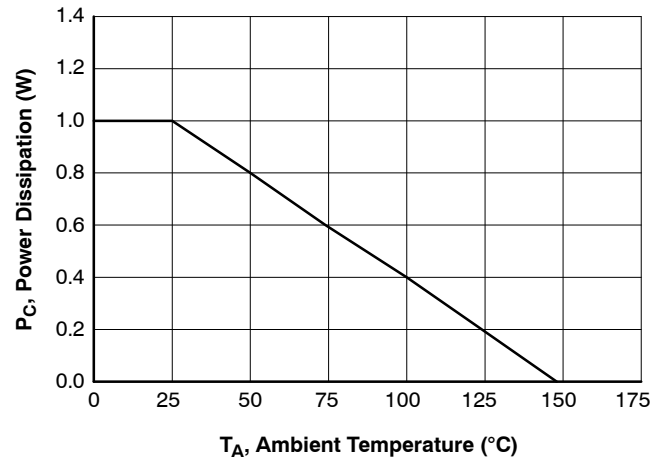

Figure 6. Power Derating



**onsemi**, **Onsemi**, and other names, marks, and brands are registered and/or common law trademarks of Semiconductor Components Industries, LLC dba "**onsemi**" or its affiliates and/or subsidiaries in the United States and/or other countries. **onsemi** owns the rights to a number of patents, trademarks, copyrights, trade secrets, and other intellectual property. A listing of **onsemi**'s product/patent coverage may be accessed at [www.onsemi.com/site/pdf/Patent-Marking.pdf](http://www.onsemi.com/site/pdf/Patent-Marking.pdf). **onsemi** reserves the right to make changes at any time to any products or information herein, without notice. The information herein is provided "as-is" and **onsemi** makes no warranty, representation or guarantee regarding the accuracy of the information, product features, availability, functionality, or suitability of its products for any particular purpose, nor does **onsemi** assume any liability arising out of the application or use of any product or circuit, and specifically disclaims any and all liability, including without limitation special, consequential or incidental damages. Buyer is responsible for its products and applications using **onsemi** products, including compliance with all laws, regulations and safety requirements or standards, regardless of any support or applications information provided by **onsemi**. "Typical" parameters which may be provided in **onsemi** data sheets and/or specifications can and do vary in different applications and actual performance may vary over time. All operating parameters, including "Typicals" must be validated for each customer application by customer's technical experts. **onsemi** does not convey any license under any of its intellectual property rights nor the rights of others. **onsemi** products are not designed, intended, or authorized for use as a critical component in life support systems or any FDA Class 3 medical devices or medical devices with a same or similar classification in a foreign jurisdiction or any devices intended for implantation in the human body. Should Buyer purchase or use **onsemi** products for any such unintended or unauthorized application, Buyer shall indemnify and hold **onsemi** and its officers, employees, subsidiaries, affiliates, and distributors harmless against all claims, costs, damages, and expenses, and reasonable attorney fees arising out of, directly or indirectly, any claim of personal injury or death associated with such unintended or unauthorized use, even if such claim alleges that **onsemi** was negligent regarding the design or manufacture of the part. **onsemi** is an Equal Opportunity/Affirmative Action Employer. This literature is subject to all applicable copyright laws and is not for resale in any manner.

## ADDITIONAL INFORMATION

### TECHNICAL PUBLICATIONS:

Technical Library: [www.onsemi.com/design/resources/technical-documentation](http://www.onsemi.com/design/resources/technical-documentation)  
onsemi Website: [www.onsemi.com](http://www.onsemi.com)

### ONLINE SUPPORT: [www.onsemi.com/support](http://www.onsemi.com/support)

For additional information, please contact your local Sales Representative at [www.onsemi.com/support/sales](http://www.onsemi.com/support/sales)