

# NST30010MXV6T1G, NSVT30010MXV6T1G

## Dual Matched General Purpose Transistor

### PNP Matched Pair

These transistors are housed in an ultra-small SOT563 package ideally suited for portable products. They are assembled to create a pair of devices highly matched in all parameters, eliminating the need for costly trimming. Applications are Current Mirrors; Differential, Sense and Balanced Amplifiers; Mixers; Detectors and Limiters.

#### Features

- Current Gain Matching to 10%
- Base-Emitter Voltage Matched to 2 mV
- Drop-In Replacement for Standard Device
- AEC-Q101 Qualified and PPAP Capable
- NSV Prefix for Automotive and Other Applications Requiring Unique Site and Control Change Requirements
- These are Pb-Free Devices\*

#### MAXIMUM RATINGS

Rating	Symbol	Value	Unit
Collector-Emitter Voltage	$V_{CEO}$	-30	V
Collector-Base Voltage	$V_{CBO}$	-30	V
Emitter-Base Voltage	$V_{EBO}$	-5.0	V
Collector Current - Continuous	$I_C$	-100	mAdc

Stresses exceeding Maximum Ratings may damage the device. Maximum Ratings are stress ratings only. Functional operation above the Recommended Operating Conditions is not implied. Extended exposure to stresses above the Recommended Operating Conditions may affect device reliability.



ON Semiconductor®

<http://onsemi.com>



SOT-563  
CASE 463A  
PLASTIC

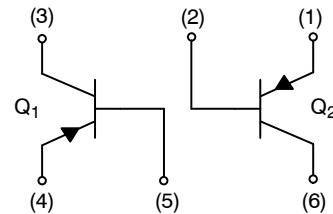

#### MARKING DIAGRAMS

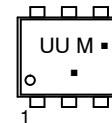

UU = Device Code  
M = Date Code  
▪ = Pb-Free Package

(Note: Microdot may be in either location)

#### ORDERING INFORMATION

Device	Package	Shipping†
NST30010MXV6T1G	SOT-563 (Pb-Free)	4,000 / Tape & Reel
NSVT30010MXV6T1G	SOT-563 (Pb-Free)	4,000 / Tape & Reel

†For information on tape and reel specifications, including part orientation and tape sizes, please refer to our Tape and Reel Packaging Specifications Brochure, BRD8011/D.

\*For additional information on our Pb-Free strategy and soldering details, please download the ON Semiconductor Soldering and Mounting Techniques Reference Manual, SOLDERRM/D.

# NST30010MXV6T1G, NSVT30010MXV6T1G

## THERMAL CHARACTERISTICS

Characteristic	Parameter	Symbol	One Device Heated	Both Devices Heated	Unit
Total Device Dissipation, T <sub>A</sub> = 25°C (Note 1) Derate above 25°C (Note 1) T <sub>A</sub> = 25°C (Note 2) Derate above 25°C (Note 2)	Two Devices Heated Total Package	P <sub>D</sub>	357 2.9 429 3.4	500 (250 ea) 4.0 661 (331 ea) 5.3	mW mW/°C mW mW/°C
Thermal Resistance Junction-to-Ambient (Note 1) Junction-to-Ambient (Note 2)	One Heated Device	R <sub>θJA</sub>	350 291	250 189	°C/W
Thermal Resistance Junction-to-Ambient (Note 1) Junction-to-Ambient (Note 2)	Unheated Device Heated by Heated Device	Ψ <sub>JA</sub>	149 88	- -	°C/W
Thermal Resistance Junction-to-Lead (Note 1) Junction-to-Lead (Note 2)	Lead Attached to Heated Device	Ψ <sub>JL</sub>	128 152	76 85	°C/W
Thermal Resistance Junction-to-Lead (Note 1) Junction-to-Lead (Note 2)	Heated Device Heating Lead Attached to Unheated Device	Ψ <sub>JL</sub>	224 222	- -	°C/W
Junction and Storage Temperature Range		T <sub>J</sub> , T <sub>stg</sub>	-55 to +150		°C

1. PCB with 51 square millimeter of 2 oz (0.070mm thick) copper heat spreading connected to package leads. Mounted on a FR4 PCB 76x76x1.5mm Single layer traces. Natural convection test according to JEDEC 51.
2. PCB with 250 square millimeter of 2 oz (0.070mm thick) copper heat spreading connected to package leads. Mounted on a FR4 PCB 76x76x1.5mm Single layer traces. Natural convection test according to JEDEC 51.

## ELECTRICAL CHARACTERISTICS (T<sub>A</sub> = 25°C unless otherwise noted)

Characteristic	Symbol	Min	Typ	Max	Unit
----------------	--------	-----	-----	-----	------

### OFF CHARACTERISTICS

Collector - Emitter Breakdown Voltage, (I <sub>C</sub> = -10 mA)	V <sub>(BR)CEO</sub>	-30	-	-	V
Collector - Emitter Breakdown Voltage, (I <sub>C</sub> = -10 μA, V <sub>EB</sub> = 0)	V <sub>(BR)CES</sub>	-30	-	-	V
Collector - Base Breakdown Voltage, (I <sub>C</sub> = -10 μA)	V <sub>(BR)CBO</sub>	-30	-	-	V
Emitter - Base Breakdown Voltage, (I <sub>E</sub> = -1.0 μA)	V <sub>(BR)EBO</sub>	-5.0	-	-	V
Collector Cutoff Current (V <sub>CB</sub> = -30 V) (V <sub>CB</sub> = -30 V, T <sub>A</sub> = 150°C)	I <sub>CBO</sub>	-	-	-15 -4.0	nA μA

### ON CHARACTERISTICS

DC Current Gain (I <sub>C</sub> = -10 μA, V <sub>CE</sub> = -5.0 V) (I <sub>C</sub> = -2.0 mA, V <sub>CE</sub> = -5.0 V) (I <sub>C</sub> = -2.0 mA, V <sub>CE</sub> = -5.0 V) (Note 3)	h <sub>FE</sub>  h <sub>FE(1)1</sub> /h <sub>FE(2)1</sub>	270 420 0.9	- 520 1.0	- 800 -	-
Collector - Emitter Saturation Voltage (I <sub>C</sub> = -10 mA, I <sub>B</sub> = -0.5 mA) (I <sub>C</sub> = -100 mA, I <sub>B</sub> = -5.0 mA)	V <sub>CE(sat)</sub>	- -	- -	-0.30 -0.60	V
Base - Emitter Saturation Voltage (I <sub>C</sub> = -10 mA, I <sub>B</sub> = -1.0 mA) (I <sub>C</sub> = -100 mA, I <sub>B</sub> = -10 mA)	V <sub>BE(sat)</sub>	- -	-0.75 -0.90	- -	V
Base - Emitter On Voltage (I <sub>C</sub> = -2.0 mA, V <sub>CE</sub> = -5.0 V) (I <sub>C</sub> = -10 mA, V <sub>CE</sub> = -5.0 V) (I <sub>C</sub> = -2.0 mA, V <sub>CE</sub> = -5.0 V) (Note 4)	V <sub>BE(on)</sub>  V <sub>BE(1)1</sub> - V <sub>BE(2)1</sub>	-0.60 - -	- - 1.0	-0.75 -0.82 2.0	V mV

### SMALL-SIGNAL CHARACTERISTICS

Current - Gain - Bandwidth Product, (I <sub>C</sub> = -10 mA, V <sub>CE</sub> = -5 Vdc, f = 100 MHz)	f <sub>T</sub>	100	-	-	MHz
Output Capacitance, (V <sub>CB</sub> = -10 V, f = 1.0 MHz)	C <sub>ob</sub>	-	-	4.5	pF
Noise Figure, (I <sub>C</sub> = -0.2 mA, V <sub>CE</sub> = -5 Vdc, R <sub>S</sub> = 2 kΩ, f = 1 kHz, BW = 200Hz)	NF	-	-	10	dB

3. h<sub>FE(1)1</sub>/h<sub>FE(2)1</sub> is the ratio of one transistor compared to the other transistor within the same package. The smaller h<sub>FE</sub> is used as numerator.
4. V<sub>BE(1)1</sub> - V<sub>BE(2)1</sub> is the absolute difference of one transistor compared to the other transistor within the same package.

TYPICAL CHARACTERISTICS

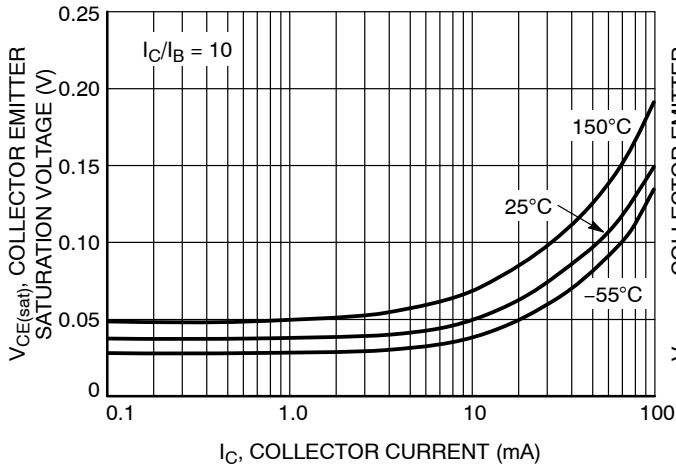

Figure 1. Collector Emitter Saturation Voltage vs. Collector Current

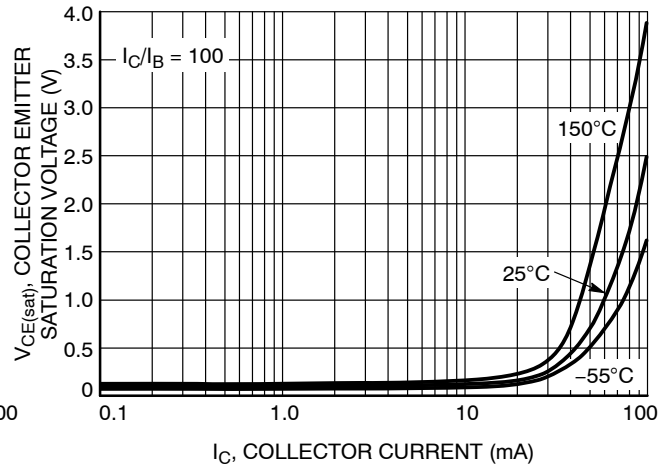

Figure 2. Collector Emitter Saturation Voltage vs. Collector Current

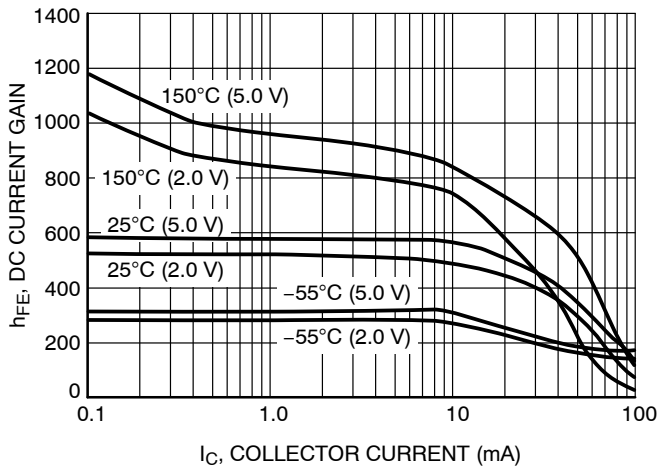

Figure 3. DC Current Gain vs. Collector Current

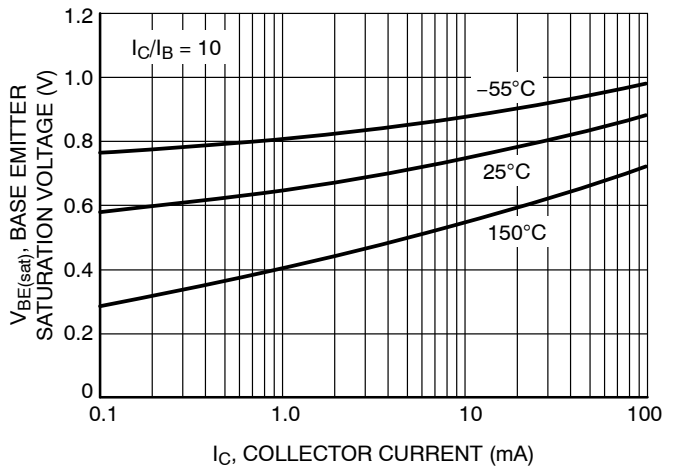

Figure 4. Base Emitter Saturation Voltage vs. Collector Current

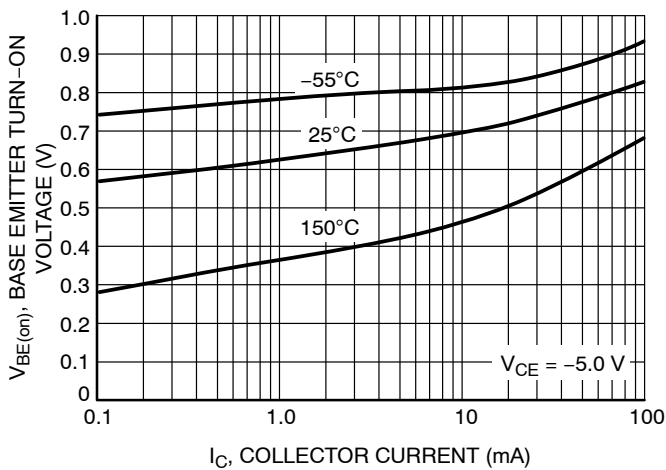

Figure 5. Base Emitter Turn-On Voltage vs. Collector Current

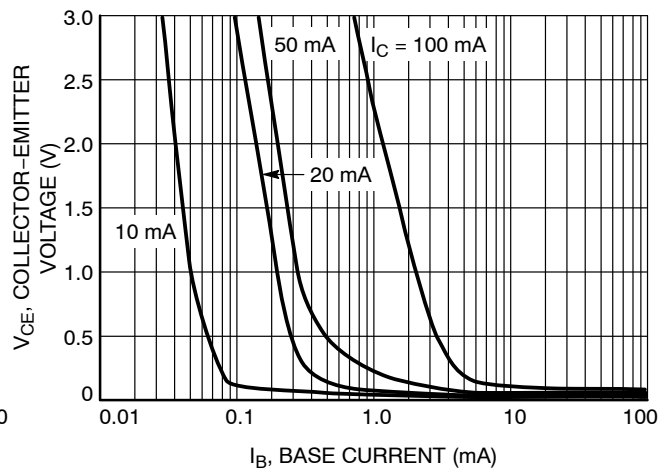

Figure 6. Saturation Region @ 25°C

# NST30010MXV6T1G, NSVT30010MXV6T1G

## TYPICAL CHARACTERISTICS

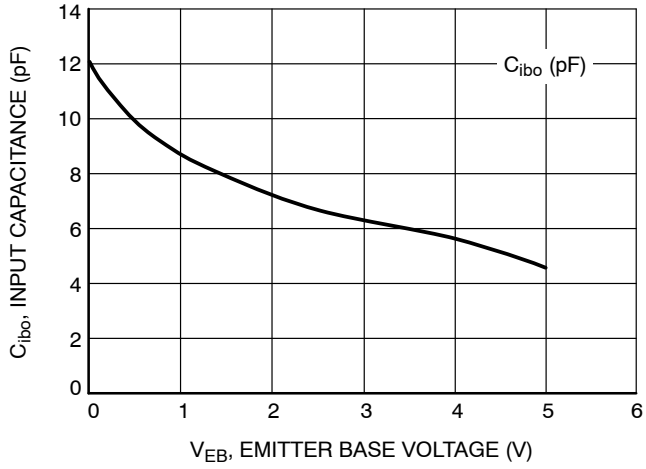

Figure 7. Input Capacitance

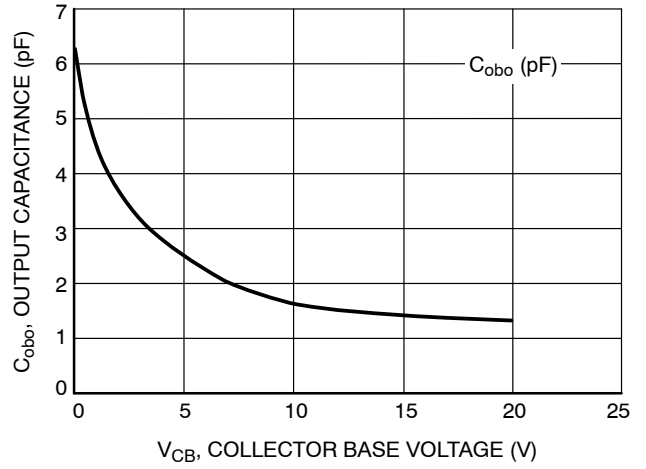
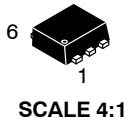

Figure 8. Output Capacitance

# MECHANICAL CASE OUTLINE

## PACKAGE DIMENSIONS



**SOT-563, 6 LEAD**  
CASE 463A  
ISSUE H

DATE 26 JAN 2021

**NOTES:**

1. DIMENSIONING AND TOLERANCING PER ASME Y14.5M, 2009.
2. CONTROLLING DIMENSION: MILLIMETERS
3. MAXIMUM LEAD THICKNESS INCLUDES LEAD FINISH THICKNESS. MINIMUM LEAD THICKNESS IS THE MINIMUM THICKNESS OF BASE MATERIAL.

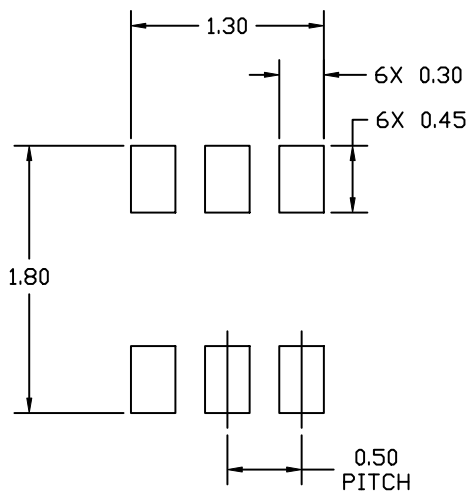
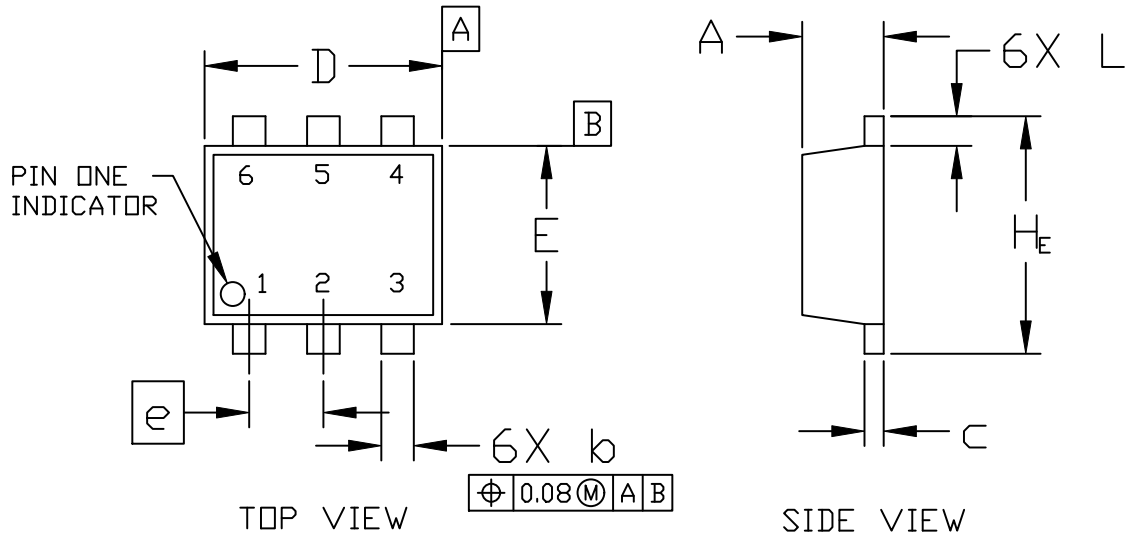

DIM	MILLIMETERS		
	MIN.	NOM.	MAX.
A	0.50	0.55	0.60
b	0.17	0.22	0.27
c	0.08	0.13	0.18
D	1.50	1.60	1.70
E	1.10	1.20	1.30
e	0.50 BSC		
L	0.10	0.20	0.30
H <sub>E</sub>	1.50	1.60	1.70

**RECOMMENDED MOUNTING FOOTPRINT\***

\* For additional information on our Pb-Free strategy and soldering details, please download the ON Semiconductor Soldering and Mounting Techniques Reference Manual, SOLDERRM/D.

<b>DOCUMENT NUMBER:</b>	<b>98AON11126D</b>	Electronic versions are uncontrolled except when accessed directly from the Document Repository. Printed versions are uncontrolled except when stamped "CONTROLLED COPY" in red.
<b>DESCRIPTION:</b>	<b>SOT-563, 6 LEAD</b>	<b>PAGE 1 OF 2</b>

onsemi and ONSEMI are trademarks of Semiconductor Components Industries, LLC dba onsemi or its subsidiaries in the United States and/or other countries. onsemi reserves the right to make changes without further notice to any products herein. onsemi makes no warranty, representation or guarantee regarding the suitability of its products for any particular purpose, nor does onsemi assume any liability arising out of the application or use of any product or circuit, and specifically disclaims any and all liability, including without limitation special, consequential or incidental damages. onsemi does not convey any license under its patent rights nor the rights of others.

# MECHANICAL CASE OUTLINE

## PACKAGE DIMENSIONS



### SOT-563, 6 LEAD

#### CASE 463A

#### ISSUE H

DATE 26 JAN 2021

- |   |  |   |
|---|--|---|
| <b>STYLE 1:</b><br>PIN 1. EMITTER 1<br>2. BASE 1<br>3. COLLECTOR 2<br>4. EMITTER 2<br>5. BASE 2<br>6. COLLECTOR 1 | <b>STYLE 2:</b><br>PIN 1. EMITTER 1<br>2. EMITTER 2<br>3. BASE 2<br>4. COLLECTOR 2<br>5. BASE 1<br>6. COLLECTOR 1  | <b>STYLE 3:</b><br>PIN 1. CATHODE 1<br>2. CATHODE 1<br>3. ANODE/ANODE 2<br>4. CATHODE 2<br>5. CATHODE 2<br>6. ANODE/ANODE 1 |
| <b>STYLE 4:</b><br>PIN 1. COLLECTOR<br>2. COLLECTOR<br>3. BASE<br>4. EMITTER<br>5. COLLECTOR<br>6. COLLECTOR      | <b>STYLE 5:</b><br>PIN 1. CATHODE<br>2. CATHODE<br>3. ANODE<br>4. ANODE<br>5. CATHODE<br>6. CATHODE                | <b>STYLE 6:</b><br>PIN 1. CATHODE<br>2. ANODE<br>3. CATHODE<br>4. CATHODE<br>5. CATHODE<br>6. CATHODE                       |
| <b>STYLE 7:</b><br>PIN 1. CATHODE<br>2. ANODE<br>3. CATHODE<br>4. CATHODE<br>5. ANODE<br>6. CATHODE               | <b>STYLE 8:</b><br>PIN 1. DRAIN<br>2. DRAIN<br>3. GATE<br>4. SOURCE<br>5. DRAIN<br>6. DRAIN                        | <b>STYLE 9:</b><br>PIN 1. SOURCE 1<br>2. GATE 1<br>3. DRAIN 2<br>4. SOURCE 2<br>5. GATE 2<br>6. DRAIN 1                     |
| <b>STYLE 10:</b><br>PIN 1. CATHODE 1<br>2. N/C<br>3. CATHODE 2<br>4. ANODE 2<br>5. N/C<br>6. ANODE 1              | <b>STYLE 11:</b><br>PIN 1. EMITTER 2<br>2. BASE 2<br>3. COLLECTOR 1<br>4. EMITTER 1<br>5. BASE 1<br>6. COLLECTOR 2 |   |

### GENERIC MARKING DIAGRAM\*

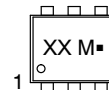

XX = Specific Device Code  
 M = Month Code  
 ▪ = Pb-Free Package

\*This information is generic. Please refer to device data sheet for actual part marking. Pb-Free indicator, "G" or microdot "▪", may or may not be present. Some products may not follow the Generic Marking.

<b>DOCUMENT NUMBER:</b>	<b>98AON11126D</b>	Electronic versions are uncontrolled except when accessed directly from the Document Repository. Printed versions are uncontrolled except when stamped "CONTROLLED COPY" in red.
<b>DESCRIPTION:</b>	<b>SOT-563, 6 LEAD</b>	<b>PAGE 2 OF 2</b>

onsemi and onsemi are trademarks of Semiconductor Components Industries, LLC dba onsemi or its subsidiaries in the United States and/or other countries. onsemi reserves the right to make changes without further notice to any products herein. onsemi makes no warranty, representation or guarantee regarding the suitability of its products for any particular purpose, nor does onsemi assume any liability arising out of the application or use of any product or circuit, and specifically disclaims any and all liability, including without limitation special, consequential or incidental damages. onsemi does not convey any license under its patent rights nor the rights of others.

**onsemi**, **Onsemi**, and other names, marks, and brands are registered and/or common law trademarks of Semiconductor Components Industries, LLC dba "**onsemi**" or its affiliates and/or subsidiaries in the United States and/or other countries. **onsemi** owns the rights to a number of patents, trademarks, copyrights, trade secrets, and other intellectual property. A listing of **onsemi**'s product/patent coverage may be accessed at [www.onsemi.com/site/pdf/Patent-Marking.pdf](http://www.onsemi.com/site/pdf/Patent-Marking.pdf). **onsemi** reserves the right to make changes at any time to any products or information herein, without notice. The information herein is provided "as-is" and **onsemi** makes no warranty, representation or guarantee regarding the accuracy of the information, product features, availability, functionality, or suitability of its products for any particular purpose, nor does **onsemi** assume any liability arising out of the application or use of any product or circuit, and specifically disclaims any and all liability, including without limitation special, consequential or incidental damages. Buyer is responsible for its products and applications using **onsemi** products, including compliance with all laws, regulations and safety requirements or standards, regardless of any support or applications information provided by **onsemi**. "Typical" parameters which may be provided in **onsemi** data sheets and/or specifications can and do vary in different applications and actual performance may vary over time. All operating parameters, including "Typicals" must be validated for each customer application by customer's technical experts. **onsemi** does not convey any license under any of its intellectual property rights nor the rights of others. **onsemi** products are not designed, intended, or authorized for use as a critical component in life support systems or any FDA Class 3 medical devices or medical devices with a same or similar classification in a foreign jurisdiction or any devices intended for implantation in the human body. Should Buyer purchase or use **onsemi** products for any such unintended or unauthorized application, Buyer shall indemnify and hold **onsemi** and its officers, employees, subsidiaries, affiliates, and distributors harmless against all claims, costs, damages, and expenses, and reasonable attorney fees arising out of, directly or indirectly, any claim of personal injury or death associated with such unintended or unauthorized use, even if such claim alleges that **onsemi** was negligent regarding the design or manufacture of the part. **onsemi** is an Equal Opportunity/Affirmative Action Employer. This literature is subject to all applicable copyright laws and is not for resale in any manner.

---

## ADDITIONAL INFORMATION

### TECHNICAL PUBLICATIONS:

Technical Library: [www.onsemi.com/design/resources/technical-documentation](http://www.onsemi.com/design/resources/technical-documentation)  
onsemi Website: [www.onsemi.com](http://www.onsemi.com)

### ONLINE SUPPORT: [www.onsemi.com/support](http://www.onsemi.com/support)

For additional information, please contact your local Sales Representative at [www.onsemi.com/support/sales](http://www.onsemi.com/support/sales)