

Bipolar Transistor

(-)160 V, (-)0.7 A, Low $V_{CE(sat)}$,
 (PNP) NPN Single PCP

2SA1418, 2SC3648

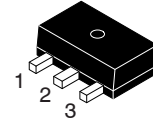

SOT-89 / PCP-1
 CASE 419AU

Features

- Adoption of FBET, MBIT Processes
- Fast Switching Speed
- Ultrasmall Size Making it Easy to Provide High-density, Small-sized Hybrid IC's
- High Breakdown Voltage and Large Current Capacity
- This is a Pb-Free Device

Applications

- Color TV Audio Output, Inverter

Specifications

(): 2SA1418

ABSOLUTE MAXIMUM RATINGS ($T_A = 25^\circ\text{C}$)

Parameter	Symbol	Conditions	Ratings	Unit
Collector-to-Base Voltage	V_{CBO}		(-)180	V
Collector-to-Emitter Voltage	V_{CEO}		(-)160	V
Emitter-to-Base Voltage	V_{EBO}		(-)6	V
Collector Current	I_C		(-)0.7	A
Collector Current (Pulse)	I_{CP}		(-)1.5	A
Collector Dissipation	P_C		500	mW
		When mounted on ceramic substrate (250 mm ² x 0.8 mm)	1.3	W
Junction Temperature	T_j		150	°C
Storage Temperature	T_{stg}		-55 to +150	°C

Stresses exceeding those listed in the Maximum Ratings table may damage the device. If any of these limits are exceeded, device functionality should not be assumed, damage may occur and reliability may be affected.

MARKING DIAGRAM

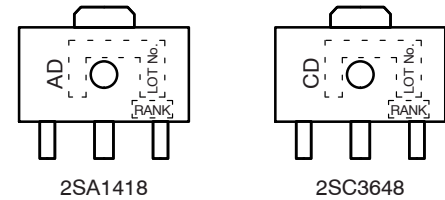

2SA1418

2SC3648

ELECTRICAL CONNECTION

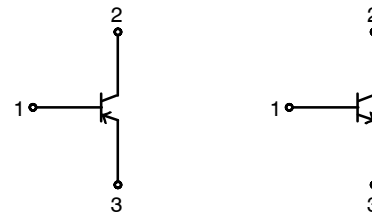

2SA1418

2SC3648

ORDERING INFORMATION

Device	Package	Shipping†
2SA1418S-TD-E	PCP (Pb-Free)	1000 / Tape & Reel
2SC3648S-TD-E		
2SC3648T-TD-E		

†For information on tape and reel specifications, including part orientation and tape sizes, please refer to our Tape and Reel Packaging Specifications Brochure, [BRD8011/D](#).

2SA1418, 2SC3648

ELECTRICAL CHARACTERISTICS (T_A = 25°C)

Parameter	Symbol	Conditions	Min	Typ	Max	Unit
Collector Cutoff Current	I _{CBO}	V _{CB} = (-)120 V, I _E = 0 A	-	-	(-)0.1	μA
Emitter Cutoff Current	I _{EBO}	V _{EB} = (-)4 V, I _C = 0 A	-	-	(-)0.1	μA
DC Current Gain	h _{FE1}	V _{CE} = (-)5 V, I _C = (-)100 mA	100*	-	400*	
	h _{FE2}	V _{CE} = (-)5 V, I _C = (-)10 mA	90	-	-	
Gain-Bandwidth Product	f _T	V _{CE} = (-)10 V, I _C = (-)50 mA	-	120	-	MHz
Output Capacitance	C _{ob}	V _{CB} = (-)10 V, f = 1 MHz	-	(11)8	-	pF
Collector-to-Emitter Saturation Voltage	V _{CE(sat)}	I _C = (-)250 mA, I _B = (-)25 mA	-	(-0.2) 0.12	(-0.5) 0.4	V
Base-to-Emitter Saturation Voltage	V _{BE(sat)}	I _C = (-)250 mA, I _B = (-)25 mA	-	(-)0.85	(-)1.2	V
Collector-to-Base Breakdown Voltage	V _{(BR)CBO}	I _C = (-)10 μA, I _E = 0 A	(-)180	-	-	V
Collector-to-Emitter Breakdown Voltage	V _{(BR)CEO}	I _C = (-)1 mA, R _{BE} = ∞	(-)160	-	-	V
Emitter-to-Base Breakdown Voltage	V _{(BR)EBO}	I _E = (-)10 μA, I _C = 0 A	(-)6	-	-	V
Turn-ON Time	t _{on}	See specified Test Circuit	-	(60) 50	-	ns
Storage Time	t _{stg}		-	(900) 1000	-	ns
Fall Time	t _f		-	(60) 60	-	ns

Product parametric performance is indicated in the Electrical Characteristics for the listed test conditions, unless otherwise noted. Product performance may not be indicated by the Electrical Characteristics if operated under different conditions.

* The 2SA1418 / 2SC3648 are classified by 100 mA h_{FE} as follows:

Rank	R	S	T
h _{FE}	100 to 200	140 to 280	200 to 400

Switching Time Test Circuit

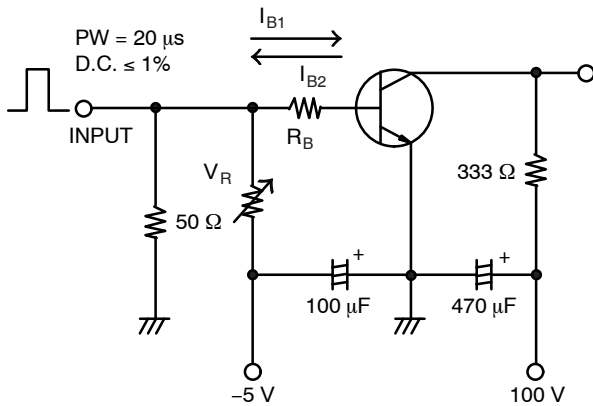

I_C = 20I_{B1} = -20I_{B2} = 300 mA
(For PNP, the polarity is reversed)

Figure 1. Switching Time Test Circuit

2SA1418, 2SC3648

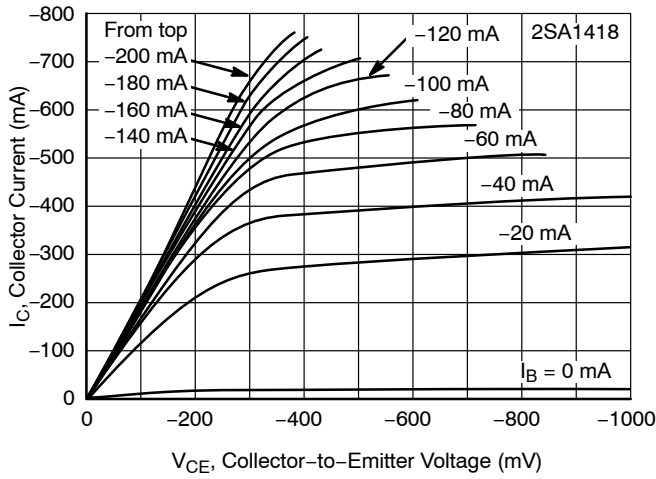

Figure 2. $I_C - V_{CE}$

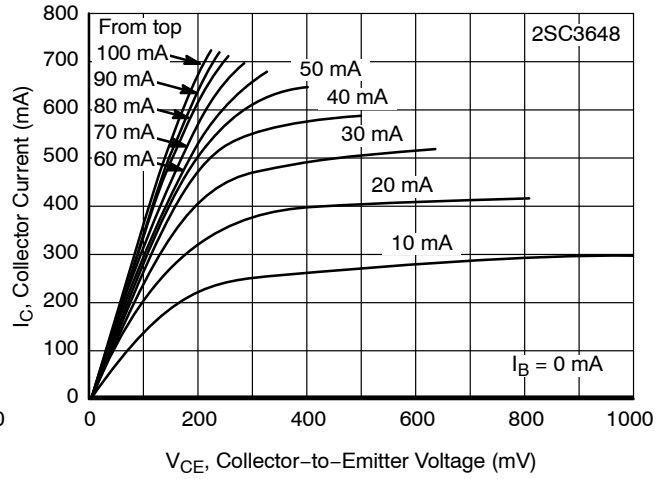

Figure 3. $I_C - V_{CE}$

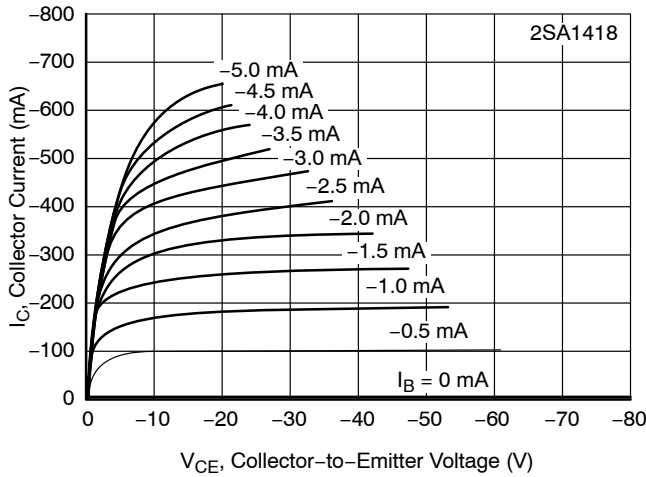

Figure 4. $I_C - V_{CE}$

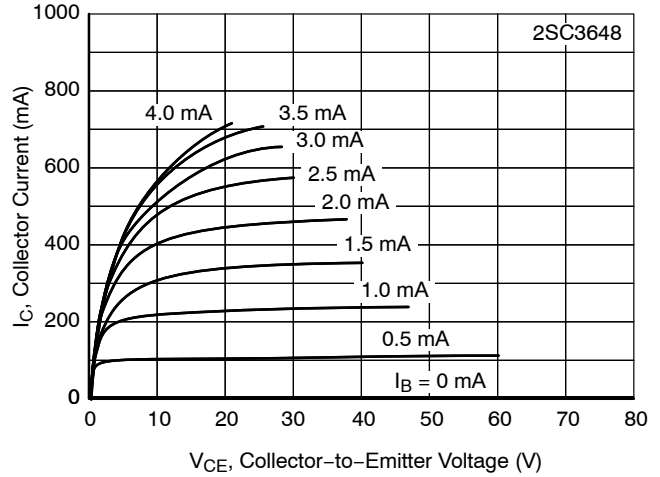

Figure 5. $I_C - V_{CE}$

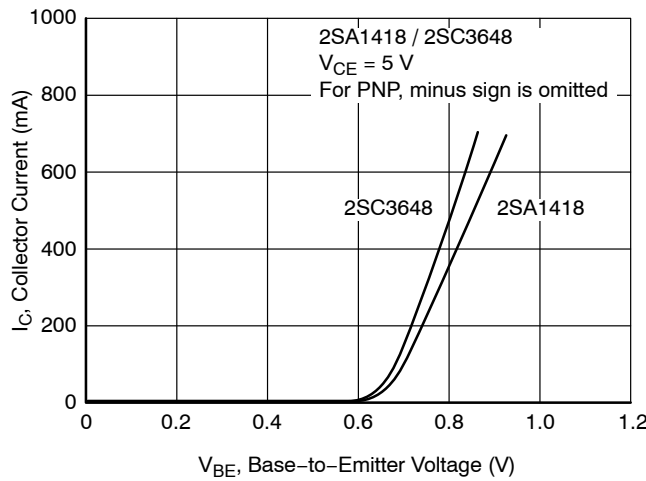

Figure 6. $I_C - V_{BE}$

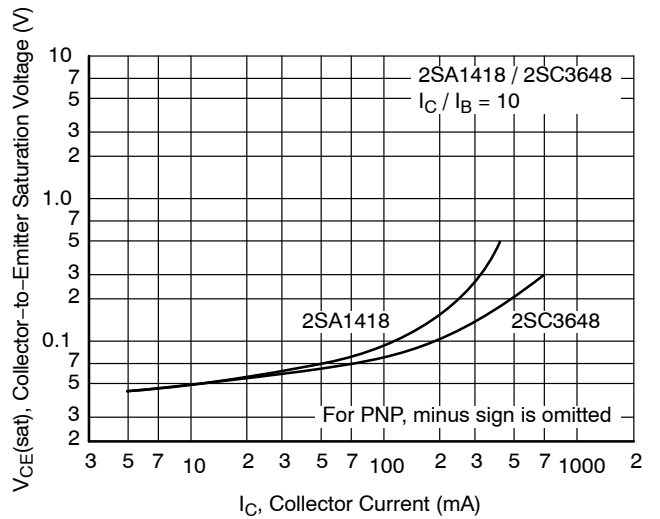

Figure 7. $V_{CE(sat)} - I_C$

2SA1418, 2SC3648

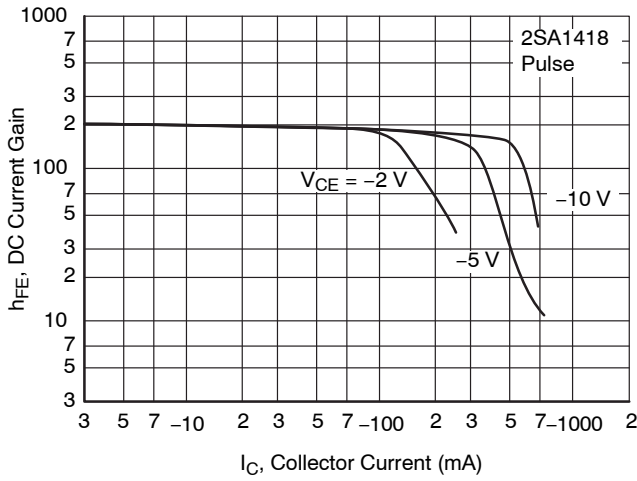

Figure 8. $h_{FE} - I_C$

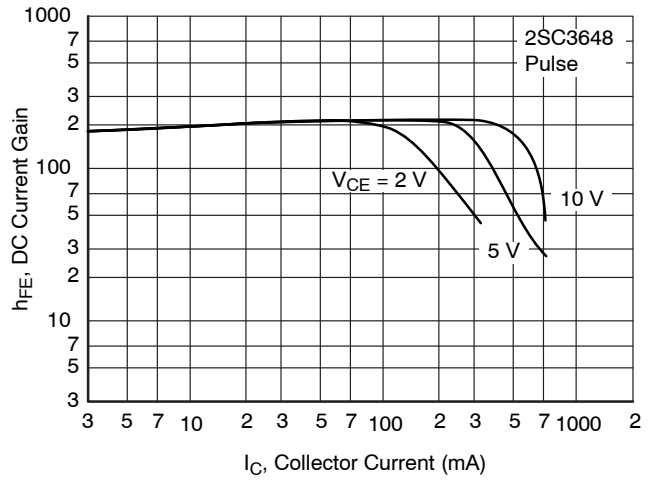

Figure 9. $h_{FE} - I_C$

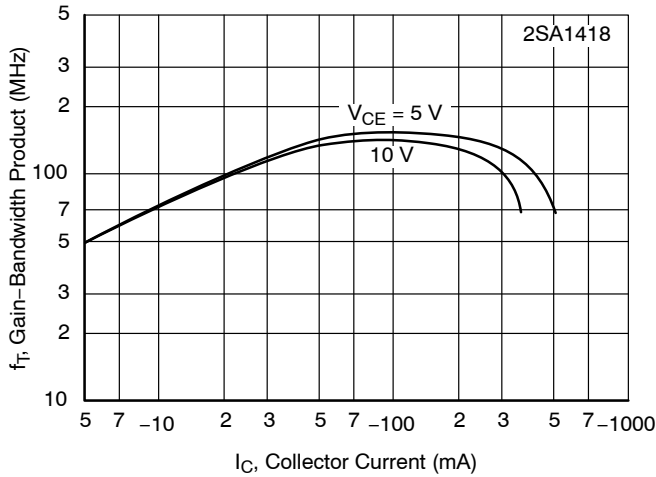

Figure 10. $f_T - I_C$

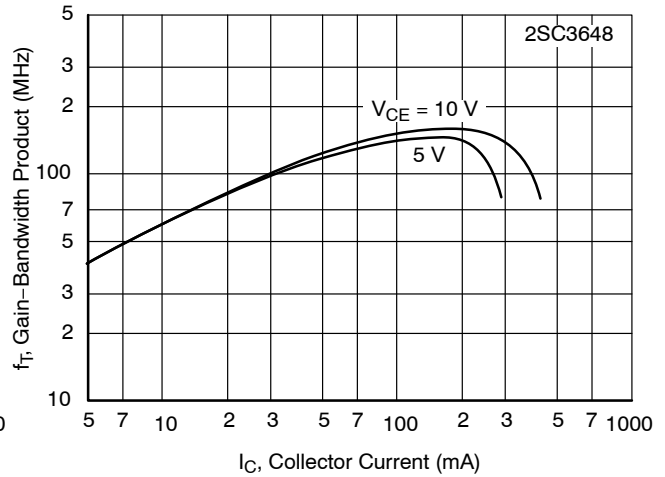

Figure 11. $f_T - I_C$

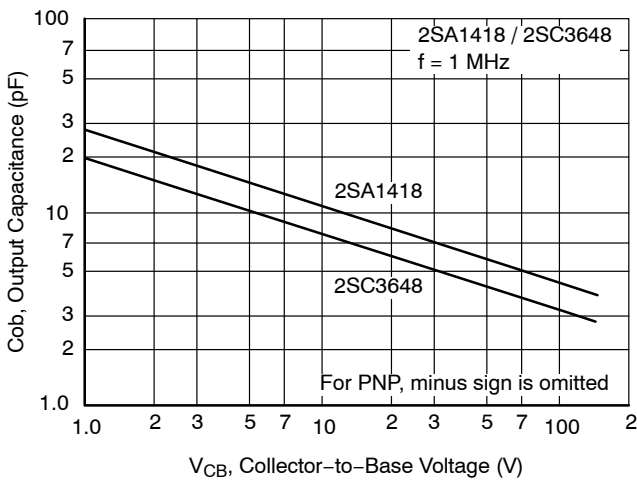

Figure 12. $C_{ob} - V_{CB}$

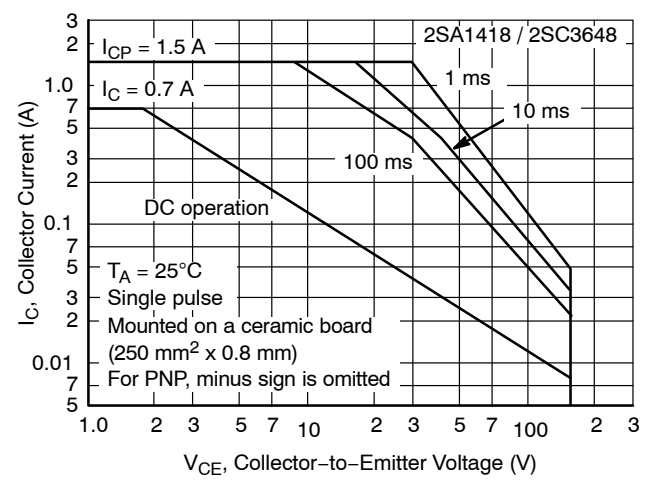

Figure 13. ASO

2SA1418, 2SC3648

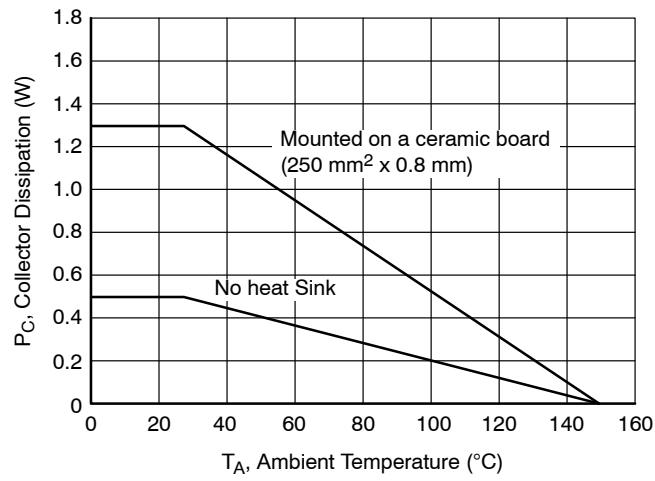
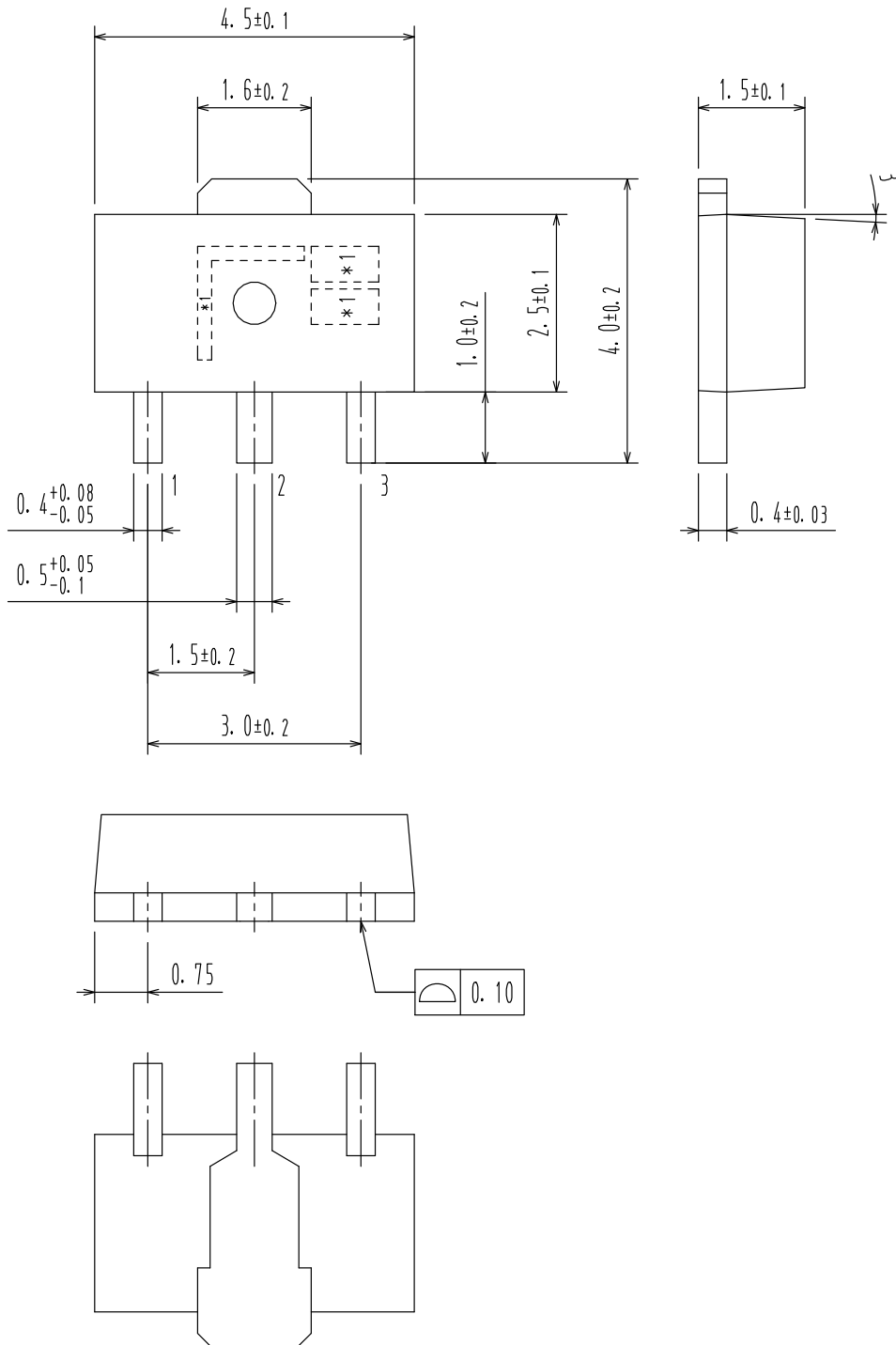

Figure 14. $P_C - T_A$

MECHANICAL CASE OUTLINE
PACKAGE DIMENSIONS

SOT-89 / PCP-1
CASE 419AU
ISSUE 0

DATE 30 APR 2012



DOCUMENT NUMBER:	98AON79746E	Electronic versions are uncontrolled except when accessed directly from the Document Repository. Printed versions are uncontrolled except when stamped "CONTROLLED COPY" in red.
DESCRIPTION:	SOT-89 / PCP-1	PAGE 1 OF 1

ON Semiconductor and  are trademarks of Semiconductor Components Industries, LLC dba ON Semiconductor or its subsidiaries in the United States and/or other countries. ON Semiconductor reserves the right to make changes without further notice to any products herein. ON Semiconductor makes no warranty, representation or guarantee regarding the suitability of its products for any particular purpose, nor does ON Semiconductor assume any liability arising out of the application or use of any product or circuit, and specifically disclaims any and all liability, including without limitation special, consequential or incidental damages. ON Semiconductor does not convey any license under its patent rights nor the rights of others.

onsemi, **Onsemi**, and other names, marks, and brands are registered and/or common law trademarks of Semiconductor Components Industries, LLC dba "**onsemi**" or its affiliates and/or subsidiaries in the United States and/or other countries. **onsemi** owns the rights to a number of patents, trademarks, copyrights, trade secrets, and other intellectual property. A listing of **onsemi**'s product/patent coverage may be accessed at www.onsemi.com/site/pdf/Patent-Marking.pdf. **onsemi** reserves the right to make changes at any time to any products or information herein, without notice. The information herein is provided "as-is" and **onsemi** makes no warranty, representation or guarantee regarding the accuracy of the information, product features, availability, functionality, or suitability of its products for any particular purpose, nor does **onsemi** assume any liability arising out of the application or use of any product or circuit, and specifically disclaims any and all liability, including without limitation special, consequential or incidental damages. Buyer is responsible for its products and applications using **onsemi** products, including compliance with all laws, regulations and safety requirements or standards, regardless of any support or applications information provided by **onsemi**. "Typical" parameters which may be provided in **onsemi** data sheets and/or specifications can and do vary in different applications and actual performance may vary over time. All operating parameters, including "Typicals" must be validated for each customer application by customer's technical experts. **onsemi** does not convey any license under any of its intellectual property rights nor the rights of others. **onsemi** products are not designed, intended, or authorized for use as a critical component in life support systems or any FDA Class 3 medical devices or medical devices with a same or similar classification in a foreign jurisdiction or any devices intended for implantation in the human body. Should Buyer purchase or use **onsemi** products for any such unintended or unauthorized application, Buyer shall indemnify and hold **onsemi** and its officers, employees, subsidiaries, affiliates, and distributors harmless against all claims, costs, damages, and expenses, and reasonable attorney fees arising out of, directly or indirectly, any claim of personal injury or death associated with such unintended or unauthorized use, even if such claim alleges that **onsemi** was negligent regarding the design or manufacture of the part. **onsemi** is an Equal Opportunity/Affirmative Action Employer. This literature is subject to all applicable copyright laws and is not for resale in any manner.

ADDITIONAL INFORMATION

TECHNICAL PUBLICATIONS:

Technical Library: www.onsemi.com/design/resources/technical-documentation
onsemi Website: www.onsemi.com

ONLINE SUPPORT: www.onsemi.com/support

For additional information, please contact your local Sales Representative at www.onsemi.com/support/sales