

Bipolar Transistor

**-160 V, -1.5 A, Low $V_{CE(sat)}$ PNP
Single LFPAK**

NST1601CL

This device is bipolar junction transistor featuring high current, low saturation voltage, and high speed switching.

Suitable for automotive applications. AEC-Q101 qualified and PPAP capable. (NSVT1601CLTWG)

Features

- Complement to NST1602CL
- Large Current Capacitance
- Low Collector to Emitter Saturation Voltage
- Thin Profile LFPAK8 3.3 x 3.3 mm Package
- High-Speed Switching
- High Allowable Power Dissipation
- AEC-Q101 Qualified and PPAP Capable (NSVT1601CLTWG)
- These Devices are Pb-Free, Halogen Free/BFR Free and are RoHS Compliant

Typical Applications

- Load Switch
- Gate Driver Buffer
- DC-DC Converters

Specifications

ABSOLUTE MAXIMUM RATING at $T_a = 25^\circ\text{C}$

Parameter	Symbol	Value	Unit
Collector to Base Voltage	V_{CBO}	-180	V
Collector to Emitter Voltage	V_{CEO}	-160	V
Emitter to Base Voltage	V_{EBO}	-6	V
Collector Current	I_C	-1.5	A
Collector Current (Pulse)	I_{CP}	-2.5	A
Collector Dissipation	P_C (Note 1)	0.8	W
	P_C (Note 2)	2.2	
Junction Temperature	T_j	175	$^\circ\text{C}$
Storage Temperature	T_{stg}	-55 to +175	$^\circ\text{C}$

Stresses exceeding those listed in the Maximum Ratings table may damage the device. If any of these limits are exceeded, device functionality should not be assumed, damage may occur and reliability may be affected.

1. Mounted on FRB with minimum pad of Copper 2 oz
2. Mounted on FRB with 1 in/sq pad of Copper 2 oz

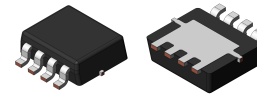

LFPAK8 3.3x3.3, 0.65P
CASE 760AD

ELECTRICAL CONNECTION

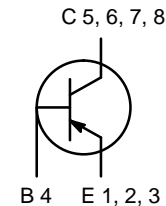

MARKING DIAGRAM

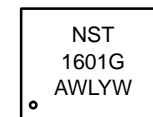

- NST1601 = Specific Device Code
A = Assembly Location
WL = Wafer Lot
Y = Year
W = Work Week
G = Pb-Free Package

ORDERING INFORMATION

See detailed ordering and shipping information in the package dimensions section on page 5 of this data sheet.

NST1601CL

ELECTRICAL CHARACTERISTICS at Ta = 25°C

Parameter	Symbol	Conditions	Value			Unit
			Min	Typ	Max	
Collector Cutoff Current	ICBO	V _{CB} = -180 V I _E = 0 A	-	-	-0.1	μA
Emitter Cutoff Current	IEBO	V _{EB} = -6 V I _C = 0 A	-	-	-0.1	μA
DC Current Gain	hFE1	V _{CE} = -5 V I _C = -100 mA	140	-	280	
	hFE2	V _{CE} = -5 V I _C = -500 mA	130	-	-	
Gain-Bandwidth Product	f _T	V _{CE} = -10 V I _C = -100 mA	-	87	-	MHz
Output Capacitance	C _{ob}	V _{CB} = -10 V f = 1 MHz	-	19	-	pF
Collector to Emitter Saturation Voltage	V _{CE(sat)1}	I _C = -250 mA I _B = -25 mA	-	-0.08	-0.16	V
	V _{CE(sat)2}	I _C = -250 mA I _B = -50 mA	-	-0.06	-0.12	V
	V _{CE(sat)3}	I _C = -500 mA I _B = -50 mA	-	-0.1	-0.2	V
Base to Emitter Saturation Voltage	V _{BE(sat)}	I _C = -250 mA I _B = -25 mA	-	-0.8	-1.2	V
Collector to Base Breakdown Voltage	V(BR)CBO	I _C = -10 μA, I _E = 0 A	-180	-	-	V
Collector to Emitter Breakdown Voltage	V(BR)CEO	I _C = -1 mA, R _{BE} = ∞	-160	-	-	V
Emitter to Base Breakdown Voltage	V(BR)EBO	I _E = -10 μA, I _C = 0 A	-6	-	-	V
Turn-On Time	t _{on}	See Figure 1	-	50	-	ns
Storage Time	t _{stg}		-	1150	-	ns
Fall Time	t _f		-	40	-	ns

Product parametric performance is indicated in the Electrical Characteristics for the listed test conditions, unless otherwise noted. Product performance may not be indicated by the Electrical Characteristics if operated under different conditions.

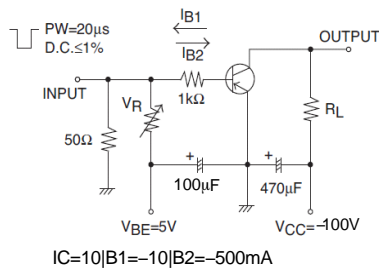

Figure 1. Switching Time Test Circuit

ESD RATING

Parameter	Symbol	Value	Unit	Class
Electrostatic Discharge –Human Body Model	HBM	>2000, <4000	V	Class 2
Electrostatic Discharge –Machine Model	MM	>400	V	Class M4

TYPICAL CHARACTERISTICS

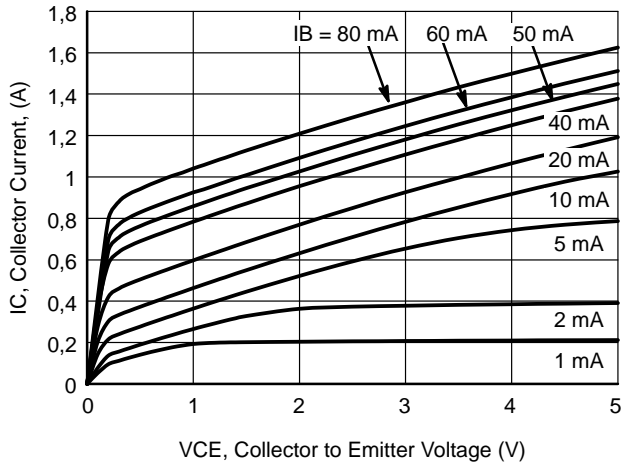

Figure 2. IC – VCE

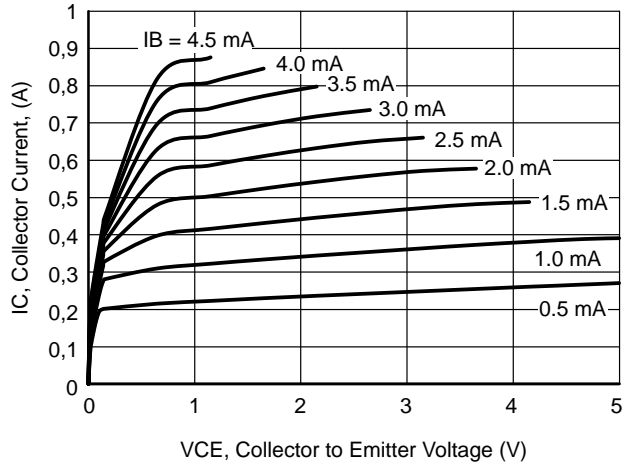

Figure 3. IC – VCE

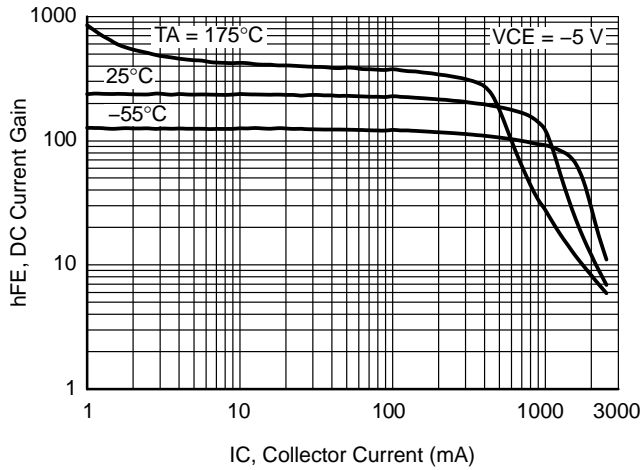

Figure 4. hFE – IC

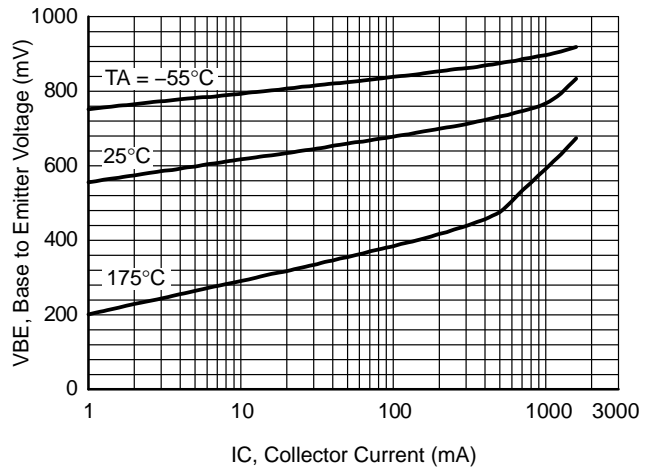

Figure 5. VBE – IC

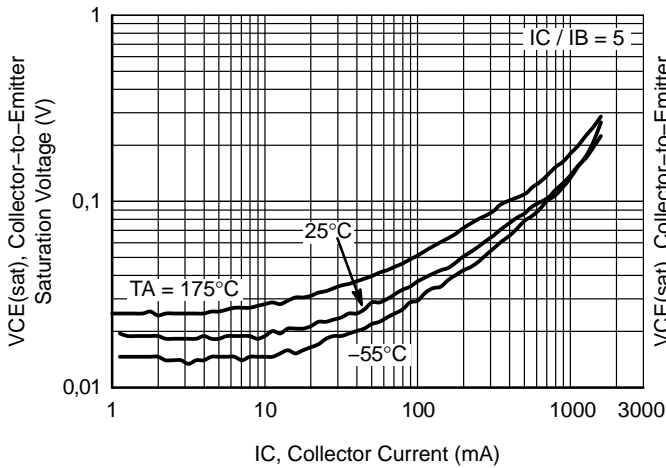

Figure 6. VCE(sat) – IC

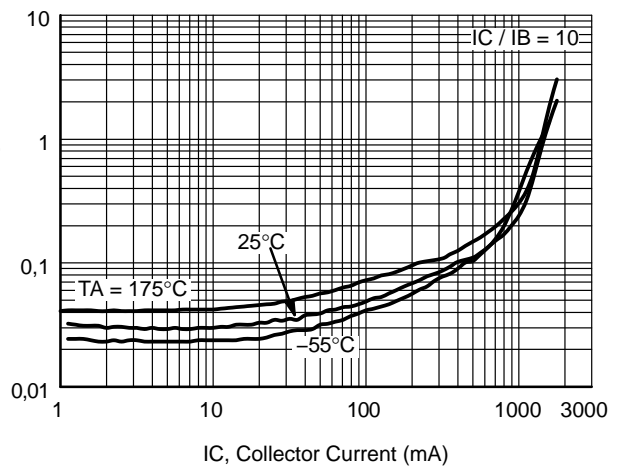

Figure 7. VCE(sat) – IC

TYPICAL CHARACTERISTICS

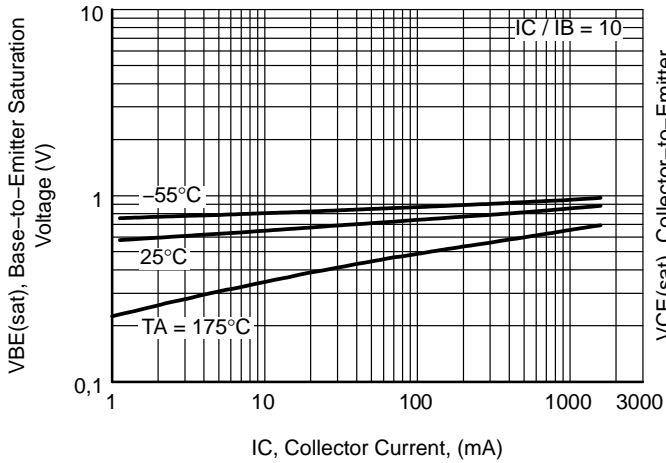

Figure 8. VBE(sat) – IC

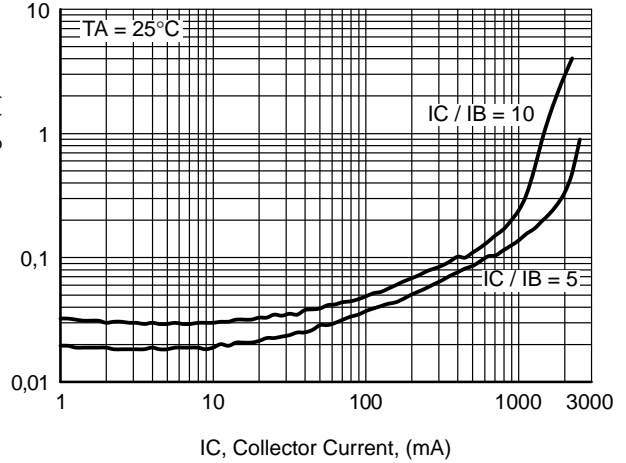

Figure 9. VCE(sat) – IC

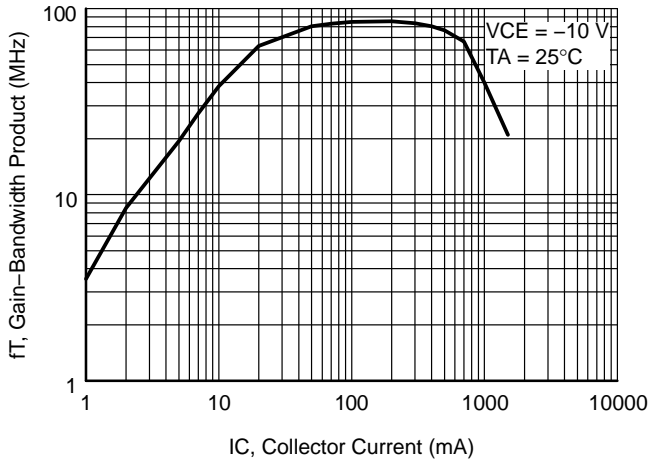

Figure 10. fT – IC

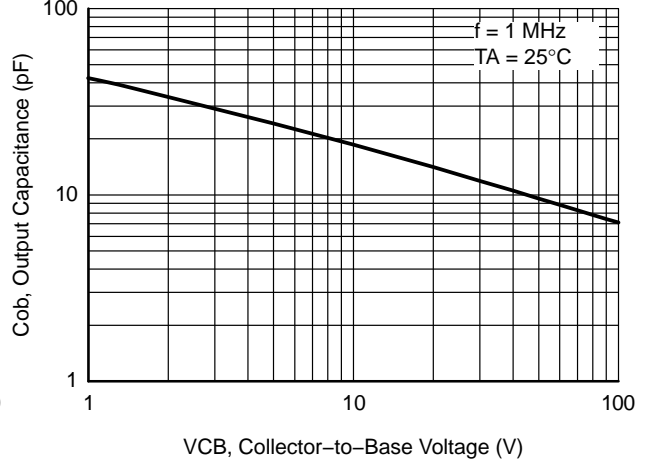

Figure 11. Cob – VCB

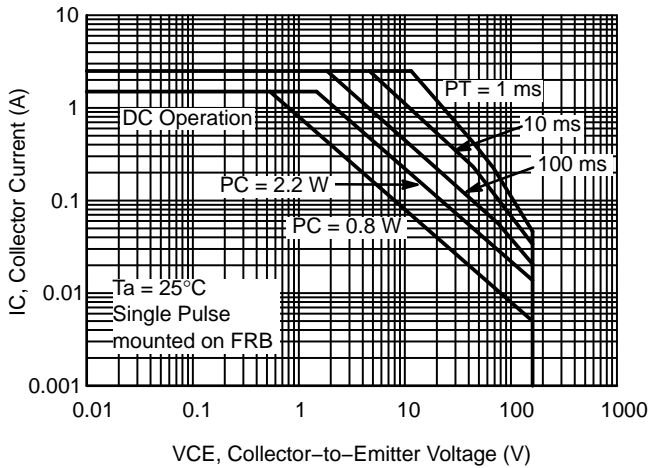

Figure 12. Safe Operating Area

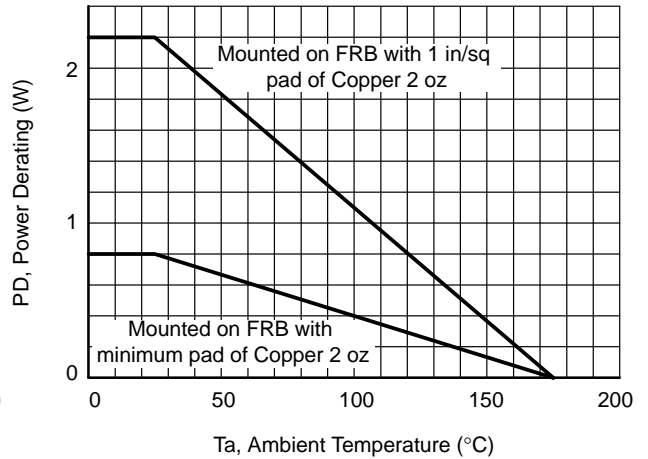

Figure 13. Power Derating

NST1601CL

ORDERING INFORMATION

Device	Marking	Package	Shipping (Qty / Packing) [†]
NSVT1601CLTWG	NST1601G	LFPAK8 (Pb-Free / Halogen Free)	3,000 / Tape & Reel
NST1601CLTWG	NST1601G	LFPAK8 (Pb-Free / Halogen Free)	3,000 / Tape & Reel

[†]For information on tape and reel specifications, including part orientation and tape sizes, please refer to our Tape and Reel Packaging Specifications Brochure, BRD8011/D

MECHANICAL CASE OUTLINE PACKAGE DIMENSIONS

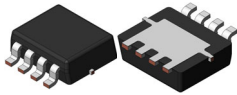

LFPAK8 3.3x3.3, 0.65P CASE 760AD ISSUE E

DATE 16 NOV 2020

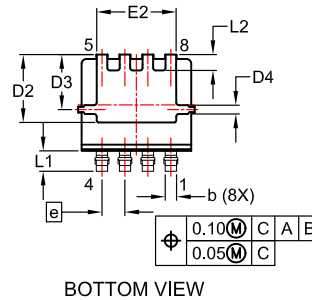
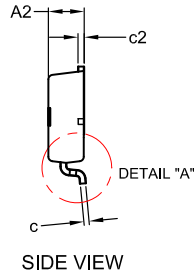
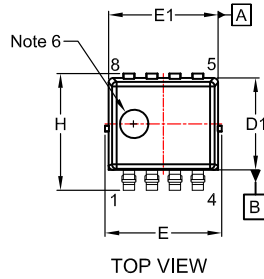

DIM	MILLIMETERS		
	MIN.	NOM.	MAX.
A	0.95	1.05	1.15
A1	0.00	0.05	0.10
A2	0.95	1.00	1.05
A3	0.15 REF		
b	0.27	0.32	0.37
c	0.12	0.17	0.22
c2	0.12	0.17	0.22
D1	2.50	2.60	2.70
D2	1.82	1.92	2.02
D3	1.46	1.56	1.66
D4	0.20	0.25	0.30
E	3.20	3.30	3.40
E1	3.00	3.10	3.20
E2	2.15	2.25	2.35
e	0.65 BSC		
H	3.20	3.30	3.40
L	0.25	0.37	0.50
L1	0.48	0.58	0.68
L2	0.35	0.45	0.55
Q	0.45	0.50	0.55
θ	0°	4°	8°

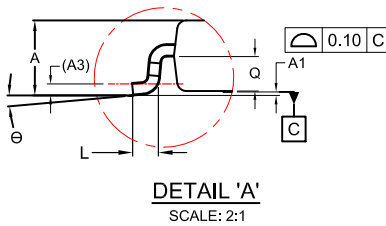

NOTES:

1. DIMENSIONING AND TOLERANCING PER ASME Y14.5M, 1994.
2. CONTROLLING DIMENSION: MILLIMETERS
3. DIMENSIONS D AND E DO NOT INCLUDE MOLD FLASH, PROTRUSIONS, OR BURRS. MOLD FLASH, PROTRUSIONS OR BURRS SHALL NOT EXCEED 0.150mm PER SIDE.
4. DIMENSIONS D AND E ARE DETERMINED AT THE OUTERMOST EXTREMES OF THE PLASTIC BODY.
5. DATUMS A AND B ARE DETERMINED AT DATUM PLANE H.
6. OPTIONAL MOLD FEATURE.

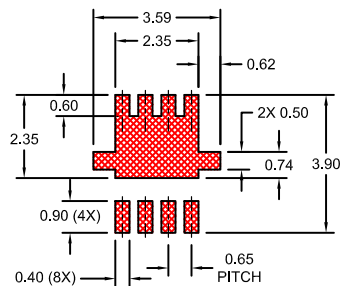

*FOR ADDITIONAL INFORMATION ON OUR Pb-FREE STRATEGY AND SOLDERING DETAILS, PLEASE DOWNLOAD THE ON SEMICONDUCTOR SOLDERING AND MOUNTING TECHNIQUES REFERENCE MANUAL, SOLDERRM/D.

GENERIC MARKING DIAGRAM*



- XXXX = Specific Device Code
- A = Assembly Location
- WL = Wafer Lot
- Y = Year
- W = Work Week

*This information is generic. Please refer to device data sheet for actual part marking. Pb-Free indicator, "G" or microdot "•", may or may not be present. Some products may not follow the Generic Marking.

DOCUMENT NUMBER:	98AON05544H	Electronic versions are uncontrolled except when accessed directly from the Document Repository. Printed versions are uncontrolled except when stamped "CONTROLLED COPY" in red.
DESCRIPTION:	LFPAK8 3.3x3.3, 0.65P	PAGE 1 OF 1

onsemi and onsemi are trademarks of Semiconductor Components Industries, LLC dba onsemi or its subsidiaries in the United States and/or other countries. onsemi reserves the right to make changes without further notice to any products herein. onsemi makes no warranty, representation or guarantee regarding the suitability of its products for any particular purpose, nor does onsemi assume any liability arising out of the application or use of any product or circuit, and specifically disclaims any and all liability, including without limitation special, consequential or incidental damages. onsemi does not convey any license under its patent rights nor the rights of others.

onsemi, **Onsemi**, and other names, marks, and brands are registered and/or common law trademarks of Semiconductor Components Industries, LLC dba "**onsemi**" or its affiliates and/or subsidiaries in the United States and/or other countries. **onsemi** owns the rights to a number of patents, trademarks, copyrights, trade secrets, and other intellectual property. A listing of **onsemi**'s product/patent coverage may be accessed at www.onsemi.com/site/pdf/Patent-Marking.pdf. **onsemi** reserves the right to make changes at any time to any products or information herein, without notice. The information herein is provided "as-is" and **onsemi** makes no warranty, representation or guarantee regarding the accuracy of the information, product features, availability, functionality, or suitability of its products for any particular purpose, nor does **onsemi** assume any liability arising out of the application or use of any product or circuit, and specifically disclaims any and all liability, including without limitation special, consequential or incidental damages. Buyer is responsible for its products and applications using **onsemi** products, including compliance with all laws, regulations and safety requirements or standards, regardless of any support or applications information provided by **onsemi**. "Typical" parameters which may be provided in **onsemi** data sheets and/or specifications can and do vary in different applications and actual performance may vary over time. All operating parameters, including "Typicals" must be validated for each customer application by customer's technical experts. **onsemi** does not convey any license under any of its intellectual property rights nor the rights of others. **onsemi** products are not designed, intended, or authorized for use as a critical component in life support systems or any FDA Class 3 medical devices or medical devices with a same or similar classification in a foreign jurisdiction or any devices intended for implantation in the human body. Should Buyer purchase or use **onsemi** products for any such unintended or unauthorized application, Buyer shall indemnify and hold **onsemi** and its officers, employees, subsidiaries, affiliates, and distributors harmless against all claims, costs, damages, and expenses, and reasonable attorney fees arising out of, directly or indirectly, any claim of personal injury or death associated with such unintended or unauthorized use, even if such claim alleges that **onsemi** was negligent regarding the design or manufacture of the part. **onsemi** is an Equal Opportunity/Affirmative Action Employer. This literature is subject to all applicable copyright laws and is not for resale in any manner.

ADDITIONAL INFORMATION

TECHNICAL PUBLICATIONS:

Technical Library: www.onsemi.com/design/resources/technical-documentation
onsemi Website: www.onsemi.com

ONLINE SUPPORT: www.onsemi.com/support

For additional information, please contact your local Sales Representative at www.onsemi.com/support/sales