

# Dual NPN General Purpose Amplifier Transistor

## EMX1DXV6T1G, EMX1DXV6T5G

This NPN transistor is designed for general purpose amplifier applications. This device is housed in the SOT-563 package which is designed for low power surface mount applications, where board space is at a premium.

### Features

- Reduces Board Space
- High  $h_{FE}$ , 210–460 (Typical)
- Low  $V_{CE(sat)}$ , < 0.5 V
- NSV Prefix for Automotive and Other Applications Requiring Unique Site and Control Change Requirements; AEC-Q101 Qualified and PPAP Capable
- These Devices are Pb-Free, Halogen Free/BFR Free and are RoHS Compliant

### MAXIMUM RATINGS ( $T_A = 25^\circ\text{C}$ )

Rating	Symbol	Value	Unit
Collector-Base Voltage	$V_{(BR)CBO}$	60	Vdc
Collector-Emitter Voltage	$V_{(BR)CEO}$	50	Vdc
Emitter-Base Voltage	$V_{(BR)EBO}$	7.0	Vdc
Collector Current – Continuous	$I_C$	100	mAdc

### THERMAL CHARACTERISTICS

Characteristic (One Junction Heated)	Symbol	Max	Unit
Total Device Dissipation $T_A = 25^\circ\text{C}$ Derate above $25^\circ\text{C}$	$P_D$	357 (Note 1) 2.9 (Note 1)	mW mW/ $^\circ\text{C}$
Thermal Resistance – Junction-to-Ambient	$R_{\theta JA}$	350 (Note 1)	$^\circ\text{C}/\text{W}$
Characteristic (Both Junctions Heated)	Symbol	Max	Unit
Total Device Dissipation $T_A = 25^\circ\text{C}$ Derate above $25^\circ\text{C}$	$P_D$	500 (Note 1) 4.0 (Note 1)	mW mW/ $^\circ\text{C}$
Thermal Resistance – Junction-to-Ambient	$R_{\theta JA}$	250 (Note 1)	$^\circ\text{C}/\text{W}$
Junction and Storage Temperature Range	$T_J, T_{stg}$	-55 to +150	$^\circ\text{C}$

Stresses exceeding those listed in the Maximum Ratings table may damage the device. If any of these limits are exceeded, device functionality should not be assumed, damage may occur and reliability may be affected.

1. FR-4 @ Minimum Pad

## DUAL NPN GENERAL PURPOSE AMPLIFIER TRANSISTORS SURFACE MOUNT

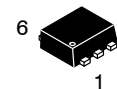
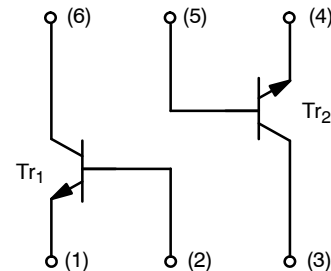

SOT-563  
CASE 463A  
STYLE 1

### MARKING DIAGRAM

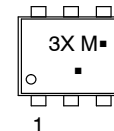

- 3X = Specific Device Code
- M = Month Code
- = Pb-Free Package

(Note: Microdot may be in either location)

### ORDERING INFORMATION

See detailed ordering and shipping information in the package dimensions section on page 2 of this data sheet.

# EMX1DXV6T1G, EMX1DXV6T5G

## ELECTRICAL CHARACTERISTICS (T<sub>A</sub> = 25°C)

Characteristic	Symbol	Min	Typ	Max	Unit
Collector-Base Breakdown Voltage (I <sub>C</sub> = 50 μAdc, I <sub>E</sub> = 0)	V <sub>(BR)CBO</sub>	60	-	-	Vdc
Collector-Emitter Breakdown Voltage (I <sub>C</sub> = 1.0 mAdc, I <sub>B</sub> = 0)	V <sub>(BR)CEO</sub>	50	-	-	Vdc
Emitter-Base Breakdown Voltage (I <sub>E</sub> = 50 μAdc, I <sub>C</sub> = 0)	V <sub>(BR)EBO</sub>	7.0	-	-	Vdc
Collector-Base Cutoff Current (V <sub>CB</sub> = 60 Vdc, I <sub>E</sub> = 0)	I <sub>CBO</sub>	-	-	0.5	μA
Emitter-Base Cutoff Current (V <sub>EB</sub> = 7.0 Vdc, I <sub>B</sub> = 0)	I <sub>EBO</sub>	-	-	0.5	μA
Collector-Emitter Saturation Voltage (Note 2) (I <sub>C</sub> = 50 mAdc, I <sub>B</sub> = 5.0 mAdc)	V <sub>CE(sat)</sub>	-	-	0.4	Vdc
DC Current Gain (Note 3) (V <sub>CE</sub> = 6.0 Vdc, I <sub>C</sub> = 1.0 mAdc)	h <sub>FE</sub>	120	-	560	-
Transition Frequency (V <sub>CE</sub> = 12 Vdc, I <sub>C</sub> = 2.0 mAdc, f = 30 MHz)	f <sub>T</sub>	-	180	-	MHz
Output Capacitance (V <sub>CB</sub> = 12 Vdc, I <sub>C</sub> = 0 Adc, f = 1 MHz)	C <sub>OB</sub>	-	2.0	-	pF

Product parametric performance is indicated in the Electrical Characteristics for the listed test conditions, unless otherwise noted. Product performance may not be indicated by the Electrical Characteristics if operated under different conditions.

2. Device mounted on a FR-4 glass epoxy printed circuit board using the minimum recommended footprint.

3. Pulse Test: Pulse Width ≤ 300 μs, D.C. ≤ 2%.

## ORDERING INFORMATION

Device	Package	Shipping†
EMX1DXV6T1G, NSVEMX1DXV6T1G	SOT-563 (Pb-Free)	4000 Units / Tape & Reel
EMX1DXV6T5G	SOT-563 (Pb-Free)	8000 Units / Tape & Reel

†For information on tape and reel specifications, including part orientation and tape sizes, please refer to our Tape and Reel Packaging Specifications Brochure, BRD8011/D.

# EMX1DXV6T1G, EMX1DXV6T5G

## TYPICAL ELECTRICAL CHARACTERISTICS

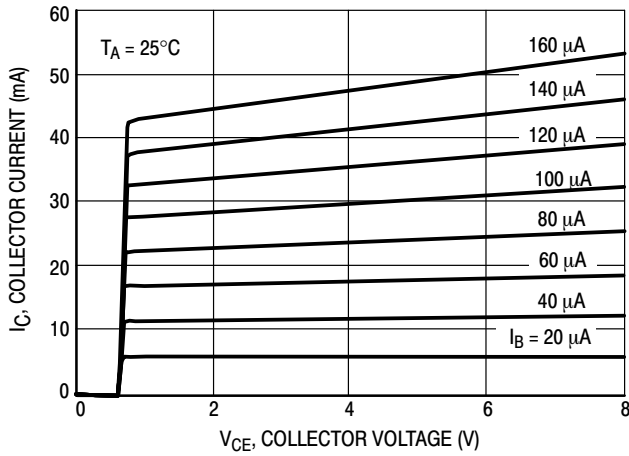

Figure 1.  $I_C - V_{CE}$

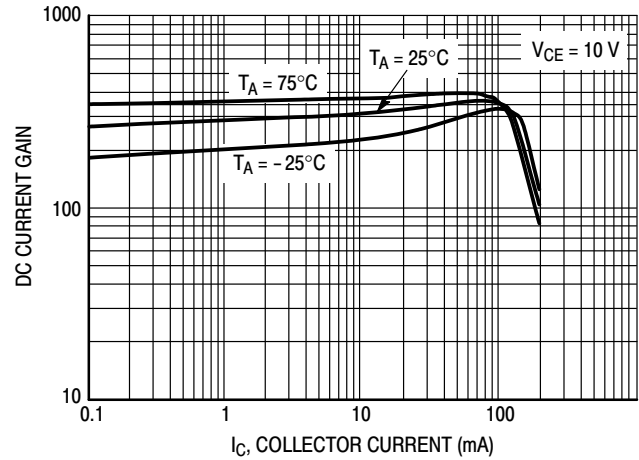

Figure 2. DC Current Gain

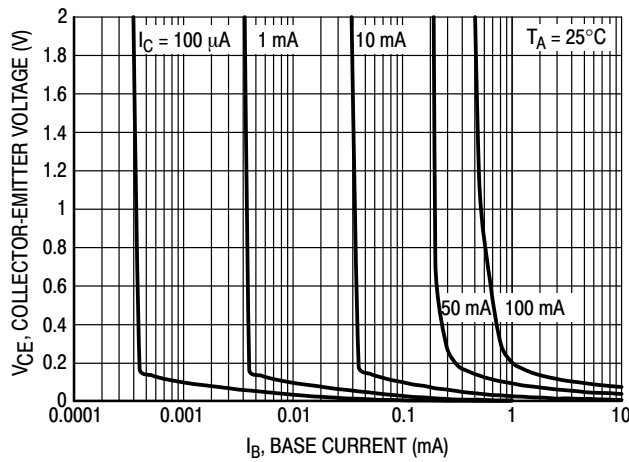

Figure 3. Collector Saturation Region

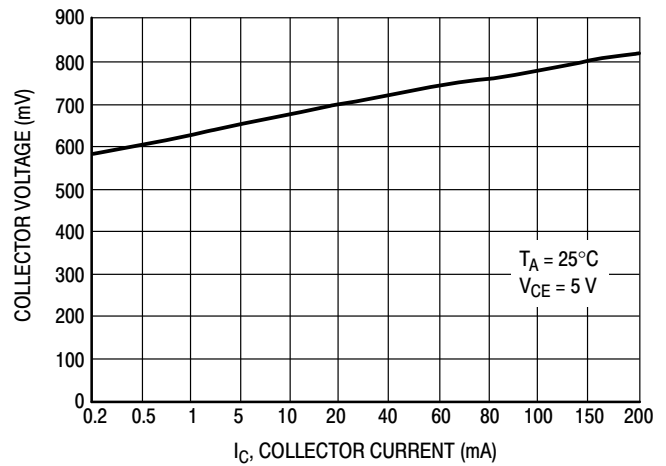

Figure 4. On Voltage

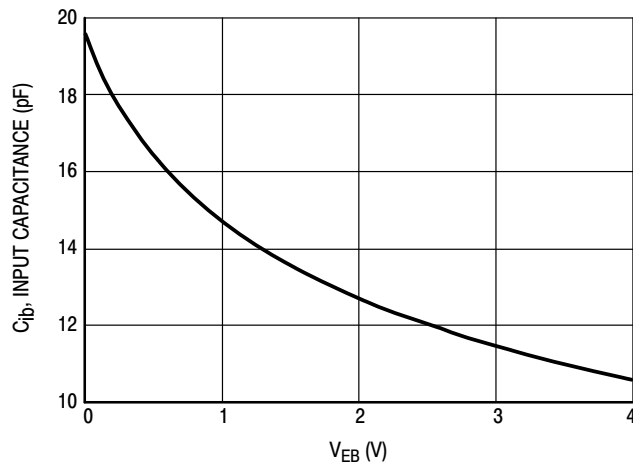

Figure 5. Capacitance

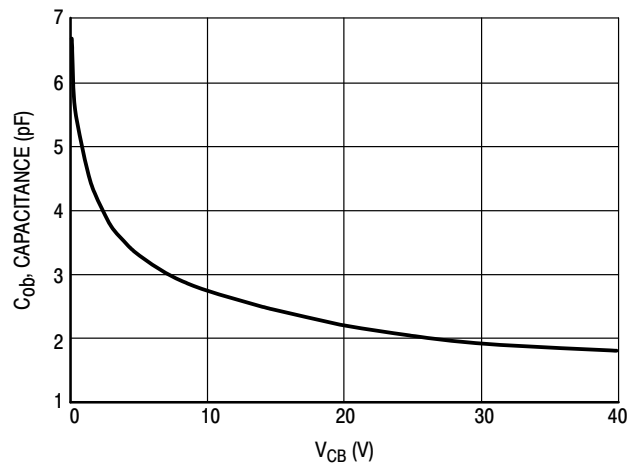
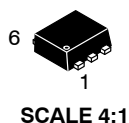

Figure 6. Capacitance

# MECHANICAL CASE OUTLINE

## PACKAGE DIMENSIONS



**SOT-563, 6 LEAD**  
CASE 463A  
ISSUE H

DATE 26 JAN 2021

**NOTES:**

1. DIMENSIONING AND TOLERANCING PER ASME Y14.5M, 2009.
2. CONTROLLING DIMENSION: MILLIMETERS
3. MAXIMUM LEAD THICKNESS INCLUDES LEAD FINISH THICKNESS. MINIMUM LEAD THICKNESS IS THE MINIMUM THICKNESS OF BASE MATERIAL.

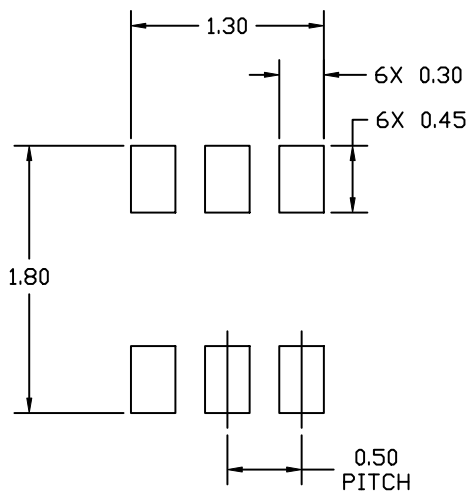
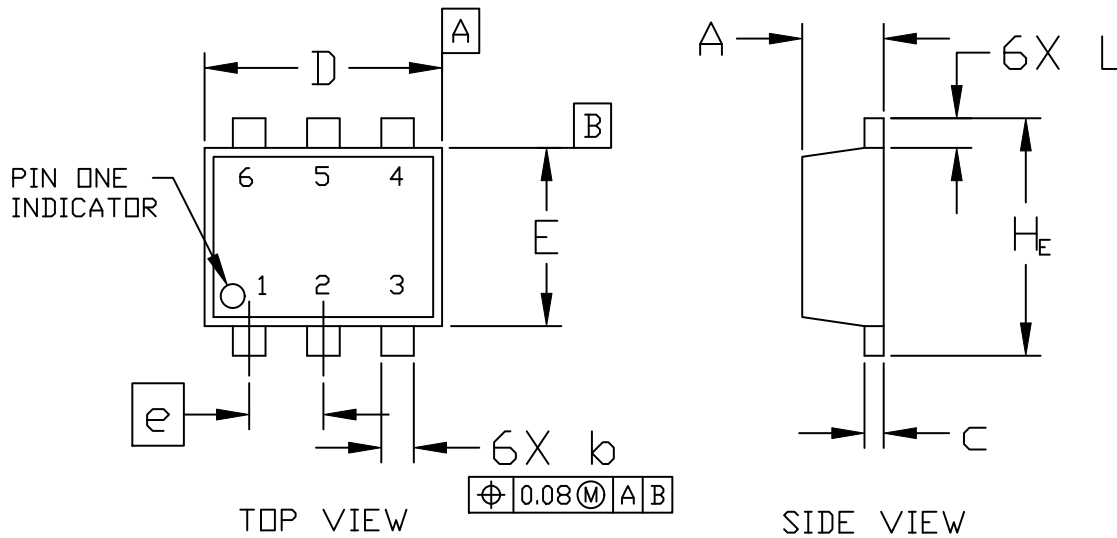

DIM	MILLIMETERS		
	MIN.	NOM.	MAX.
A	0.50	0.55	0.60
b	0.17	0.22	0.27
c	0.08	0.13	0.18
D	1.50	1.60	1.70
E	1.10	1.20	1.30
e	0.50 BSC		
L	0.10	0.20	0.30
H <sub>E</sub>	1.50	1.60	1.70

**RECOMMENDED MOUNTING FOOTPRINT\***

\* For additional information on our Pb-Free strategy and soldering details, please download the ON Semiconductor Soldering and Mounting Techniques Reference Manual, SOLDERRM/D.

<b>DOCUMENT NUMBER:</b>	<b>98AON11126D</b>	Electronic versions are uncontrolled except when accessed directly from the Document Repository. Printed versions are uncontrolled except when stamped "CONTROLLED COPY" in red.
<b>DESCRIPTION:</b>	<b>SOT-563, 6 LEAD</b>	<b>PAGE 1 OF 2</b>

onsemi and ONSEMI are trademarks of Semiconductor Components Industries, LLC dba onsemi or its subsidiaries in the United States and/or other countries. onsemi reserves the right to make changes without further notice to any products herein. onsemi makes no warranty, representation or guarantee regarding the suitability of its products for any particular purpose, nor does onsemi assume any liability arising out of the application or use of any product or circuit, and specifically disclaims any and all liability, including without limitation special, consequential or incidental damages. onsemi does not convey any license under its patent rights nor the rights of others.

# MECHANICAL CASE OUTLINE

## PACKAGE DIMENSIONS



### SOT-563, 6 LEAD

CASE 463A  
ISSUE H

DATE 26 JAN 2021

- |   |  |   |
|---|--|---|
| <p>STYLE 1:<br/>PIN 1. EMITTER 1<br/>2. BASE 1<br/>3. COLLECTOR 2<br/>4. EMITTER 2<br/>5. BASE 2<br/>6. COLLECTOR 1</p> | <p>STYLE 2:<br/>PIN 1. EMITTER 1<br/>2. EMITTER 2<br/>3. BASE 2<br/>4. COLLECTOR 2<br/>5. BASE 1<br/>6. COLLECTOR 1</p>  | <p>STYLE 3:<br/>PIN 1. CATHODE 1<br/>2. CATHODE 1<br/>3. ANODE/ANODE 2<br/>4. CATHODE 2<br/>5. CATHODE 2<br/>6. ANODE/ANODE 1</p> |
| <p>STYLE 4:<br/>PIN 1. COLLECTOR<br/>2. COLLECTOR<br/>3. BASE<br/>4. EMITTER<br/>5. COLLECTOR<br/>6. COLLECTOR</p>      | <p>STYLE 5:<br/>PIN 1. CATHODE<br/>2. CATHODE<br/>3. ANODE<br/>4. ANODE<br/>5. CATHODE<br/>6. CATHODE</p>                | <p>STYLE 6:<br/>PIN 1. CATHODE<br/>2. ANODE<br/>3. CATHODE<br/>4. CATHODE<br/>5. CATHODE<br/>6. CATHODE</p>                       |
| <p>STYLE 7:<br/>PIN 1. CATHODE<br/>2. ANODE<br/>3. CATHODE<br/>4. CATHODE<br/>5. ANODE<br/>6. CATHODE</p>               | <p>STYLE 8:<br/>PIN 1. DRAIN<br/>2. DRAIN<br/>3. GATE<br/>4. SOURCE<br/>5. DRAIN<br/>6. DRAIN</p>                        | <p>STYLE 9:<br/>PIN 1. SOURCE 1<br/>2. GATE 1<br/>3. DRAIN 2<br/>4. SOURCE 2<br/>5. GATE 2<br/>6. DRAIN 1</p>                     |
| <p>STYLE 10:<br/>PIN 1. CATHODE 1<br/>2. N/C<br/>3. CATHODE 2<br/>4. ANODE 2<br/>5. N/C<br/>6. ANODE 1</p>              | <p>STYLE 11:<br/>PIN 1. EMITTER 2<br/>2. BASE 2<br/>3. COLLECTOR 1<br/>4. EMITTER 1<br/>5. BASE 1<br/>6. COLLECTOR 2</p> |   |

### GENERIC MARKING DIAGRAM\*

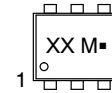

XX = Specific Device Code  
M = Month Code  
▪ = Pb-Free Package

\*This information is generic. Please refer to device data sheet for actual part marking. Pb-Free indicator, "G" or microdot "▪", may or may not be present. Some products may not follow the Generic Marking.

<b>DOCUMENT NUMBER:</b>	<b>98AON11126D</b>	Electronic versions are uncontrolled except when accessed directly from the Document Repository. Printed versions are uncontrolled except when stamped "CONTROLLED COPY" in red.
<b>DESCRIPTION:</b>	<b>SOT-563, 6 LEAD</b>	<b>PAGE 2 OF 2</b>

onsemi and onsemi are trademarks of Semiconductor Components Industries, LLC dba onsemi or its subsidiaries in the United States and/or other countries. onsemi reserves the right to make changes without further notice to any products herein. onsemi makes no warranty, representation or guarantee regarding the suitability of its products for any particular purpose, nor does onsemi assume any liability arising out of the application or use of any product or circuit, and specifically disclaims any and all liability, including without limitation special, consequential or incidental damages. onsemi does not convey any license under its patent rights nor the rights of others.

**onsemi**, **Onsemi**, and other names, marks, and brands are registered and/or common law trademarks of Semiconductor Components Industries, LLC dba "**onsemi**" or its affiliates and/or subsidiaries in the United States and/or other countries. **onsemi** owns the rights to a number of patents, trademarks, copyrights, trade secrets, and other intellectual property. A listing of **onsemi**'s product/patent coverage may be accessed at [www.onsemi.com/site/pdf/Patent-Marking.pdf](http://www.onsemi.com/site/pdf/Patent-Marking.pdf). **onsemi** reserves the right to make changes at any time to any products or information herein, without notice. The information herein is provided "as-is" and **onsemi** makes no warranty, representation or guarantee regarding the accuracy of the information, product features, availability, functionality, or suitability of its products for any particular purpose, nor does **onsemi** assume any liability arising out of the application or use of any product or circuit, and specifically disclaims any and all liability, including without limitation special, consequential or incidental damages. Buyer is responsible for its products and applications using **onsemi** products, including compliance with all laws, regulations and safety requirements or standards, regardless of any support or applications information provided by **onsemi**. "Typical" parameters which may be provided in **onsemi** data sheets and/or specifications can and do vary in different applications and actual performance may vary over time. All operating parameters, including "Typicals" must be validated for each customer application by customer's technical experts. **onsemi** does not convey any license under any of its intellectual property rights nor the rights of others. **onsemi** products are not designed, intended, or authorized for use as a critical component in life support systems or any FDA Class 3 medical devices or medical devices with a same or similar classification in a foreign jurisdiction or any devices intended for implantation in the human body. Should Buyer purchase or use **onsemi** products for any such unintended or unauthorized application, Buyer shall indemnify and hold **onsemi** and its officers, employees, subsidiaries, affiliates, and distributors harmless against all claims, costs, damages, and expenses, and reasonable attorney fees arising out of, directly or indirectly, any claim of personal injury or death associated with such unintended or unauthorized use, even if such claim alleges that **onsemi** was negligent regarding the design or manufacture of the part. **onsemi** is an Equal Opportunity/Affirmative Action Employer. This literature is subject to all applicable copyright laws and is not for resale in any manner.

## ADDITIONAL INFORMATION

### TECHNICAL PUBLICATIONS:

Technical Library: [www.onsemi.com/design/resources/technical-documentation](http://www.onsemi.com/design/resources/technical-documentation)  
onsemi Website: [www.onsemi.com](http://www.onsemi.com)

### ONLINE SUPPORT: [www.onsemi.com/support](http://www.onsemi.com/support)

For additional information, please contact your local Sales Representative at [www.onsemi.com/support/sales](http://www.onsemi.com/support/sales)