

## TPDxEUSB30 2-, 4-Channel ESD Protection for Super-Speed USB 3.0 Interface

### 1 Features

- Supports USB 3.0 data rates (5 Gbps)
- IEC 61000-4-2 ESD protection (level 4 contact)
- IEC 61000-4-5 surge protection
  - 5 A (8/20  $\mu$ s)
- Low capacitance
  - DRT: 0.7 pF (typical)
  - DQA: 0.8 pF (typical)
- Dynamic resistance: 0.6  $\Omega$  (typical)
- Space-saving DRT, DQA packages
- Flow-through pin mapping

### 2 Applications

- Notebooks
- Set-top boxes
- DVD players
- Media players
- Portable computers

### 3 Description

The TPD2EUSB30, TPD2EUSB30A, and TPD4EUSB30 are 2 and 4 channel Transient Voltage Suppressor (TVS) based Electrostatic Discharge (ESD) protection diode arrays. The TPDxEUSB30/A devices are rated to dissipate ESD strikes at the maximum level specified in the IEC 61000-4-2 international standard (Contact). These devices also offer 5 A (8/20  $\mu$ s) peak pulse current ratings per IEC 61000-4-5 (Surge) specification.

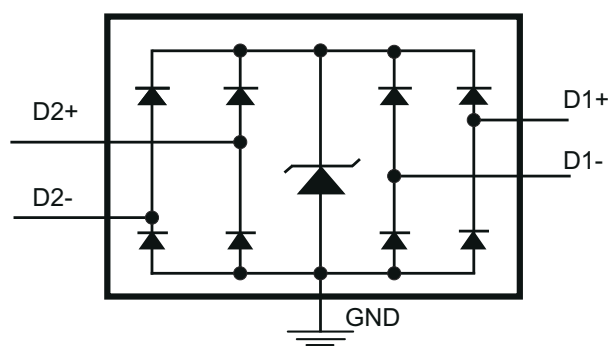
The TPD2EUSB30A offers low 4.5-V DC break-down voltage. The low capacitance, low break-down voltage, and low dynamic resistance make the TPD2EUSB30A a superior protection device for high-speed differential IOs.

The TPD2EUSB30 and TPD2EUSB30A are offered in space saving DRT (1 mm  $\times$  1 mm) package. The TPD4EUSB30 is offered in space saving DQA (2.5 mm  $\times$  1.0 mm) package.

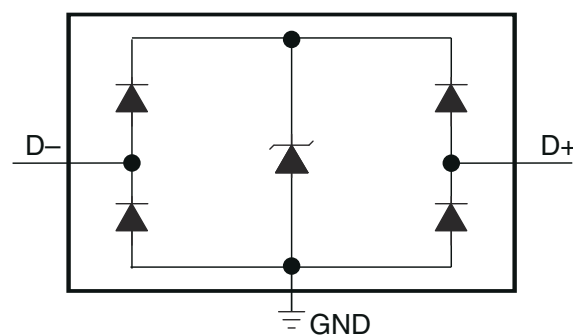
#### Device Information<sup>(1)</sup>

PART NUMBER	PACKAGE	BODY SIZE (NOM)
TPD2EUSB30	SOT (3)	1.00 mm $\times$ 0.80 mm
TPD2EUSB30A		
TPD4EUSB30	USON (10)	2.50 mm $\times$ 1.00 mm

(1) For all available packages, see the orderable addendum at the end of the data sheet.



TPD4EUSB30 Circuit



TPD2EUSB30/A Circuit



## Table of Contents

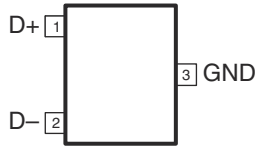
<b>1 Features</b> .....	1	7.4 Device Functional Modes.....	8
<b>2 Applications</b> .....	1	<b>8 Application and Implementation</b> .....	9
<b>3 Description</b> .....	1	8.1 Application Information.....	9
<b>4 Revision History</b> .....	2	8.2 Typical Application.....	9
<b>5 Pin Configuration and Functions</b> .....	3	<b>9 Power Supply Recommendations</b> .....	11
<b>6 Specifications</b> .....	4	<b>10 Layout</b> .....	11
6.1 Absolute Maximum Ratings.....	4	10.1 Layout Guidelines.....	11
6.2 ESD Ratings.....	4	10.2 Layout Examples.....	12
6.3 Recommended Operating Conditions.....	4	<b>11 Device and Documentation Support</b> .....	14
6.4 Thermal Information.....	4	11.1 Receiving Notification of Documentation Updates..	14
6.5 Electrical Characteristics.....	5	11.2 Support Resources.....	14
6.6 Typical Characteristics.....	6	11.3 Trademarks.....	14
<b>7 Detailed Description</b> .....	8	11.4 Electrostatic Discharge Caution.....	14
7.1 Overview.....	8	11.5 Glossary.....	14
7.2 Functional Block Diagrams.....	8	<b>12 Mechanical, Packaging, and Orderable Information</b> .....	14
7.3 Feature Description.....	8		

## 4 Revision History

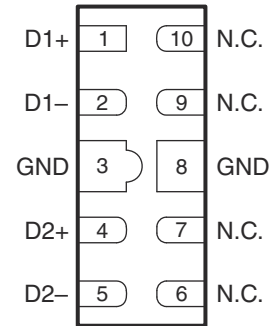
NOTE: Page numbers for previous revisions may differ from page numbers in the current version.

<b>Changes from Revision F (October 2015) to Revision G (June 2021)</b>	<b>Page</b>
• Updated the numbering format for tables, figures, and cross-references throughout the document.....	1
• Changed the <i>Pin Functions</i> table to clarify pin order and function.....	3
<b>Changes from Revision E (August 2014) to Revision F (October 2015)</b>	<b>Page</b>
• Moved the storage temperature to the <i>Absolute Maximum Ratings</i> table and updated the <i>Handling Ratings</i> table to an <i>ESD Ratings</i> table.....	4
• Added test condition frequency to capacitance .....	5
<b>Changes from Revision D (August 2012) to Revision E (July 2014)</b>	<b>Page</b>
• Added <i>Handling Rating</i> table, <i>Feature Description</i> section, <i>Device Functional Modes</i> , <i>Application and Implementation</i> section, <i>Power Supply Recommendations</i> section, <i>Layout</i> section, <i>Device and Documentation Support</i> section, and <i>Mechanical, Packaging, and Orderable Information</i> section .....	1
<b>Changes from Revision C (December 2011) to Revision D (August 2012)</b>	<b>Page</b>
• Updated Dynamic Resistance value.....	1
• Updated Dynamic Resistance value.....	5
<b>Changes from Revision B (July 2011) to Revision C (December 2011)</b>	<b>Page</b>
• Added Insertion Loss graphic to TYPICAL OPERATING CHARACTERISTICS section.....	6
<b>Changes from Revision A (December 2010) to Revision B (July 2011)</b>	<b>Page</b>
• Changed TOP-SIDE MARKING column in the Ordering Information Table .....	3
<b>Changes from Revision * (August 2010) to Revision A (December 2010)</b>	<b>Page</b>
• Added TPS2EUSB30A part to document.....	1

## 5 Pin Configuration and Functions



**Figure 5-1. DRT Package 3-Pin SOT Top View**



**Figure 5-2. DQA Package 10-Pin USON Top View**

**Table 5-1. Pin Functions**

PIN			TYPE	DESCRIPTION
NAME	DRT	DQA		
D1+	1	1	ESD port	High-speed ESD clamp, provides ESD protection to the high-speed differential data lines.
D1–	2	2		
D2+	—	4		
D2–	—	5		
GND	3	3, 8	GND	Ground
N.C.	—	6, 7, 9, 10	—	Not normally connected

## 6 Specifications

### 6.1 Absolute Maximum Ratings

over operating free-air temperature range (unless otherwise noted)<sup>(1)</sup>

		MIN	MAX	UNIT
IO voltage (D+ and D- pins)	TPD2EUSB30, TPD4EUSB30	0	6	V
	TPD2EUSB30A	0	4	
IEC 61000-4-5 surge current ( $t_p = 8/20 \mu\text{s}$ )		D+, D- pins		5
IEC 61000-4-5 surge peak power ( $t_p = 8/20 \mu\text{s}$ )		D+, D- pins		45
$T_A$	Operating free-air temperature	-40	85	°C
$T_{\text{stg}}$	Storage temperature	-65	125	°C

- (1) Stresses beyond those listed under Absolute Maximum Ratings may cause permanent damage to the device. These are stress ratings only, and functional operation of the device at these or any other conditions beyond those indicated in the operational sections of the specifications is not implied. Exposure to absolute maximum-rated conditions for extended periods may affect device reliability.

### 6.2 ESD Ratings

		VALUE	UNIT	
$V_{\text{(ESD)}}$ Electrostatic discharge	Human body model (HBM), per ANSI/ESDA/JEDEC JS-001, all pins <sup>(1)</sup>	2500	V	
	Charged device model (CDM), per JEDEC specification JESD22-C101, all pins <sup>(2)</sup>	1500		
	IEC 61000-4-2 Contact Discharge	D+, D- pins		8000
	IEC 61000-4-2 Air-Gap Discharge (TPD2EUSB30/A)	D+, D- pins		8000
	IEC 61000-4-2 Air-Gap Discharge (TPD4EUSB30)	D+, D- pins		9000

- (1) JEDEC document JEP155 states that 500-V HBM allows safe manufacturing with a standard ESD control process.  
 (2) JEDEC document JEP157 states that 250-V CDM allows safe manufacturing with a standard ESD control process.

### 6.3 Recommended Operating Conditions

over operating free-air temperature range (unless otherwise noted)

		MIN	MAX	UNIT
$T_A$	operating free-air temperature	-40	85	°C
Operating Voltage	TPD2EUSB30, TPD4EUSB30	0	5.5	V
	TPD2EUSB30A	0	3.6	

### 6.4 Thermal Information

THERMAL METRIC <sup>(1)</sup>		TPD2EUSB30	TPD2EUSB30A	TPD4EUSB30	UNIT
		DRT (SOT)	DRT (SOT)	DQA (USON)	
		3 PINS	3 PINS	10 PINS	
$R_{\theta JA}$	Junction-to-ambient thermal resistance	610.2	610.2	162.2	°C/W
$R_{\theta JC(\text{top})}$	Junction-to-case (top) thermal resistance	288.0	288.0	128.3	°C/W
$R_{\theta JB}$	Junction-to-board thermal resistance	118.4	118.4	56.7	°C/W
$\psi_{JT}$	Junction-to-top characterization parameter	20.2	20.2	13.8	°C/W
$\psi_{JB}$	Junction-to-board characterization parameter	116.4	116.4	56.6	°C/W
$R_{\theta JC(\text{bot})}$	Junction-to-case (bottom) thermal resistance	N/A	N/A	8.1	°C/W

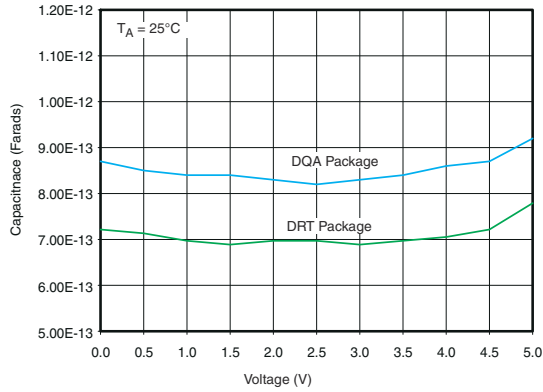
- (1) For more information about traditional and new thermal metrics, see the *Semiconductor and IC Package Thermal Metrics* application report, [SPRA953](#).

## 6.5 Electrical Characteristics

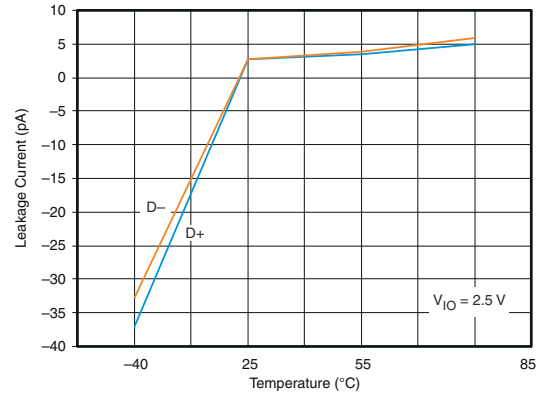
over operating free-air temperature range (unless otherwise noted)

PARAMETER		TEST CONDITIONS	MIN	TYP	MAX	UNIT
$V_{RWM}$	Reverse stand-off voltage (D+ and D- pins)	TPD2EUSB30, TPD4EUSB30			5.5	V
		TPD2EUSB30A			3.6	V
$V_{clamp}$	Clamp voltage	D+,D- pins to ground, $I_{IO} = 1\text{ A}$			8	V
$I_{IO}$	Current from IO port to supply pins	$V_{IO} = 2.5\text{ V}$ , $I_D = 8\text{ mA}$		0.01	0.1	$\mu\text{A}$
$V_D$	Diode forward voltage	D+,D- pins, lower clamp diode, $V_{IO} = 2.5\text{ V}$ , $I_D = 8\text{ mA}$	0.6	0.8	0.95	V
$R_{dyn}$	Dynamic resistance	D+,D- pins $I = 1\text{ A}$		0.6		$\Omega$
$C_{IO-IO}$	Capacitance IO to IO	D+,D- pins $V_{IO} = 2.5\text{ V}$ ; $f = 100\text{ kHz}$		0.05		pF
$C_{IO-GND}$	Capacitance IO to GND	D+,D- pins (DRT)		0.7		pF
		D1+, D1-, D2+, D2- (DQA)	$V_{IO} = 2.5\text{ V}$ ; $f = 100\text{ kHz}$	0.8		
$V_{BR}$	Break-down voltage, TPD2EUSB30, TPD4EUSB30	$I_{IO} = 1\text{ mA}$		7		V
	Break-down voltage, TPD2EUSB30A	$I_{IO} = 1\text{ mA}$		4.5		V

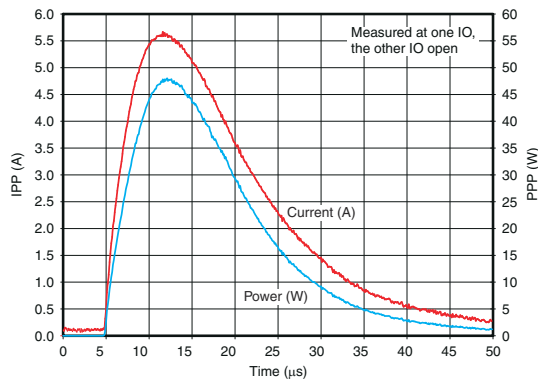
## 6.6 Typical Characteristics



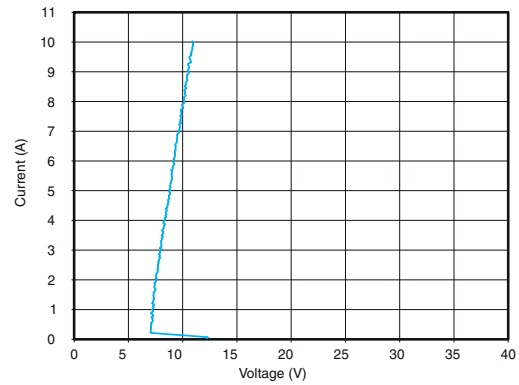
$T_A = 25^\circ\text{C}$   
**Figure 6-1. IO Capacitance vs IO Voltage**



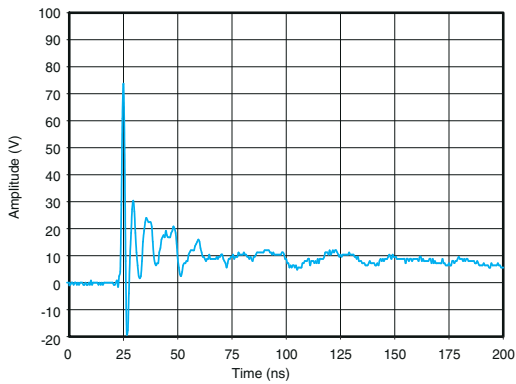
$V_{IO} = 2.5\text{ V}$   
**Figure 6-2. Leakage Current vs Temperature**



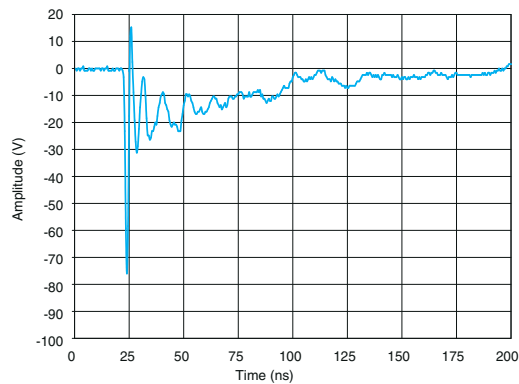
Measured at one IO, the other IO open  
**Figure 6-3. Peak Pulse Waveforms**



**Figure 6-4. D+,D- Transmission Line Pulsar Plot for TPD2EUSB30 (100 ns Pulse, 10 ns Rise Time)**

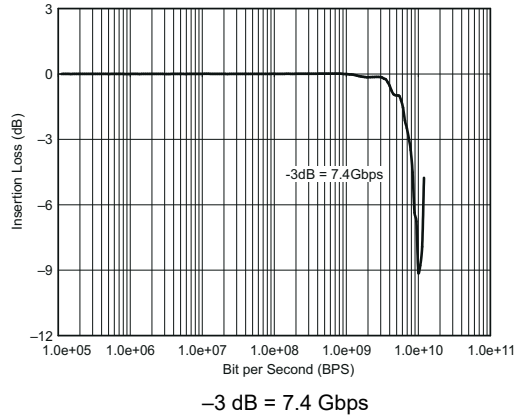


**Figure 6-5. IEC Clamping Waveforms (8 kV Contact)**



**Figure 6-6. IEC Clamping Waveforms (-8 kV Contact)**

## 6.6 Typical Characteristics (continued)



**Figure 6-7. Insertion Loss**

## 7 Detailed Description

### 7.1 Overview

The TPD2EUSB30, TPD2EUSB30A, and TPD4EUSB30 are 2 and 4 channel Transient Voltage Suppressor (TVS) based Electrostatic Discharge (ESD) protection diode arrays. The TPDxEUSB30/A devices are rated to dissipate ESD strikes at the maximum contact level specified in the IEC 61000-4-2 international standard (Contact). These devices also offer 5 A (8/20  $\mu$ s) peak pulse current ratings per IEC 61000-4-5 (surge) specification.

### 7.2 Functional Block Diagrams

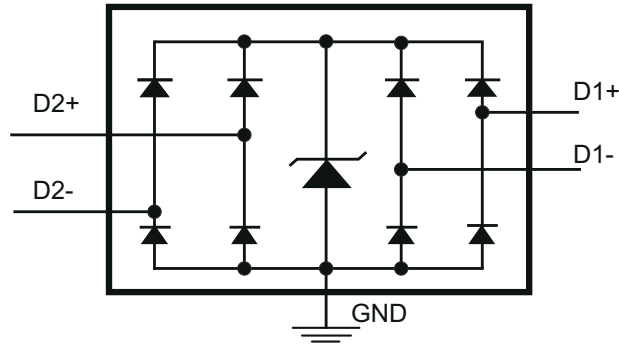


Figure 7-1. TPD4EUSB30 Circuit

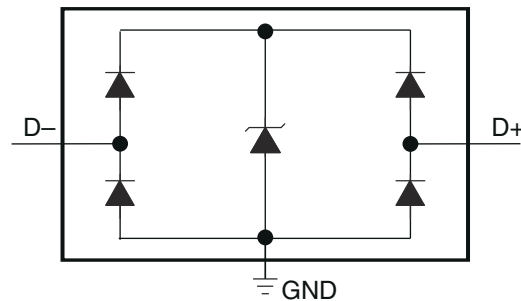


Figure 7-2. TPD2EUSB30/A Circuit

### 7.3 Feature Description

TPDxEUSB30/A is a family of uni-directional Electrostatic Discharge (ESD) protection devices with low capacitance. Each IO line is rated to dissipate ESD strikes at or above the maximum level specified in the IEC 61000-4-2 (Level 4 Contact) international standard. The TPDxEUSB30/A's low loading capacitance makes it ideal for protection super speed high-speed signals.

### 7.4 Device Functional Modes

The TPDxEUSB30/A family of devices are passive integrated circuits that activate whenever voltages above  $V_{BR}$  or below the lower diodes  $V_{forward}$  ( $-0.6V$ ) are present upon the circuit being protected. During ESD events, voltages as high as  $\pm 8$  kV (contact) can be directed to ground via the internal diode network. Once the voltages on the protected lines fall below the trigger voltage of the device (usually within 10's of nano-seconds) the device reverts to passive.



## 8 Application and Implementation

### Note

Information in the following applications sections is not part of the TI component specification, and TI does not warrant its accuracy or completeness. TI's customers are responsible for determining suitability of components for their purposes, as well as validating and testing their design implementation to confirm system functionality.

### 8.1 Application Information

The TPDxEUSB30/A family is a family of diode array type transient voltage suppressors (TVS) which are typically used to provide a path to ground for dissipating ESD events on hi-speed signal lines between a human interface connector and a system. As the current from ESD passes through the TVS, only a small voltage drop is present across the diode. This is the voltage presented to the protected IC. The low  $R_{DYN}$  of the triggered TVS holds this voltage,  $V_{CLAMP}$ , to a tolerable level to the protected IC.

### 8.2 Typical Application

This application describes a TPDxEUSB30/A eye pattern test. Figure 10-2 shows the lab board that was designed to demonstrate the degradation of the eye pattern quality with and without the TPD2EUSB30/A in the USB 3.0 signal path. The measurements show that there is only ~2 ps jitter penalty to the differential signal when the TPD2EUSB30/A device is added in the signal path. A similar setup was employed to measure the eye diagram for the TPD4EUSB30.

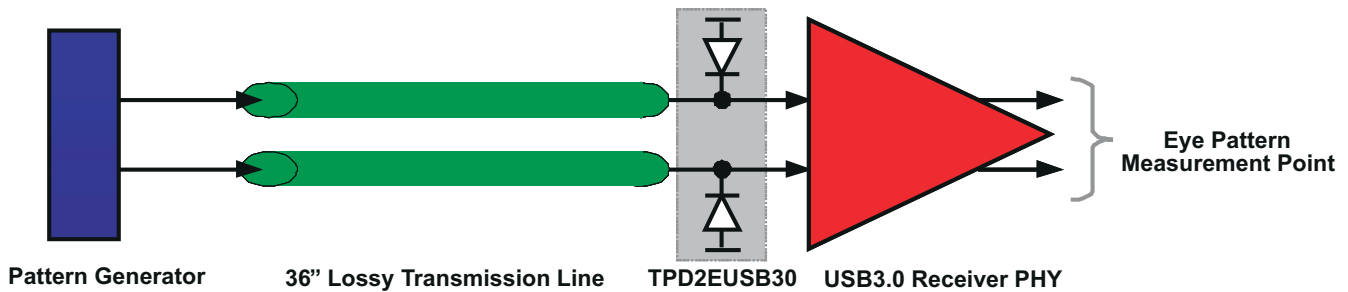


Figure 8-1. Measurement Setup to collect the Eye Pattern on a Reference Board with TPD2EUSB30/A

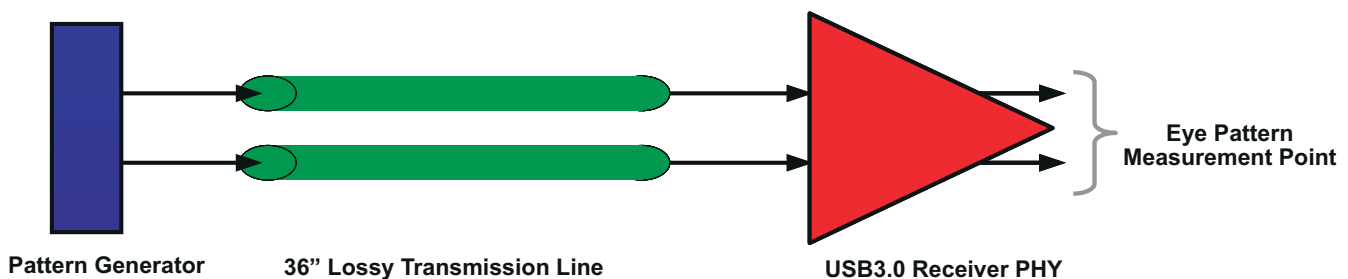


Figure 8-2. Measurement Setup to collect the Eye Pattern on a Reference Board with TPD2EUSB30/A

#### 8.2.1 Design Requirements

For this design example, a single TPD2EUSB30/A is used to protect a differential data pair lines, similar to a USB 3.0 application. Given the USB application, the following parameters are known.

Table 8-1. Design Parameters

DESIGN PARAMETER	VALUE
Signal range on D+, and D-	0 V to 3.3 V
Operating Frequency	2.5 GHz

## 8.2.2 Detailed Design Procedure

To begin the design process, some parameters must be decided upon; the designer needs to know the following:

- Signal range on all the protected lines
- Operating frequency

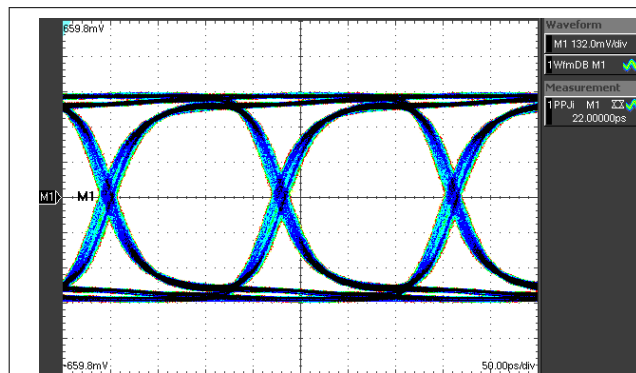
### 8.2.2.1 Signal Range on D+, D- Pins

The TPD2EUSB30 has 2 pins which support 0 to 5.5 V and the TPD2EUSB30A has 2 pins which support 0 to 3.6 V.

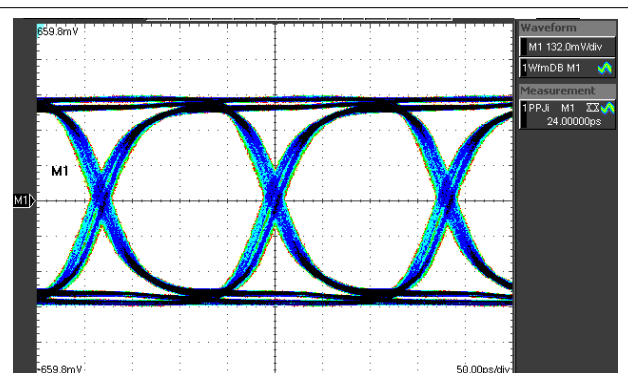
### 8.2.2.2 Operating Frequency

The 0.7 pF (TPD2EUSB30/A typ) line capacitance supports data rates in excess of 5 Gbps.

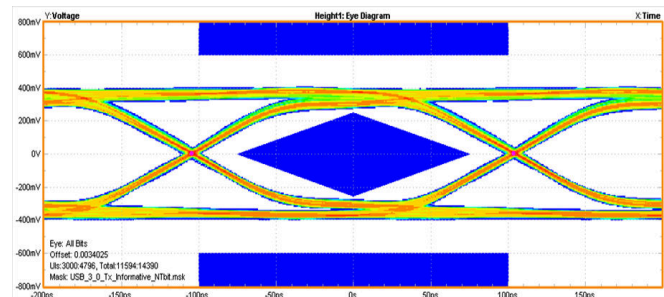
## 8.2.3 Application Curves



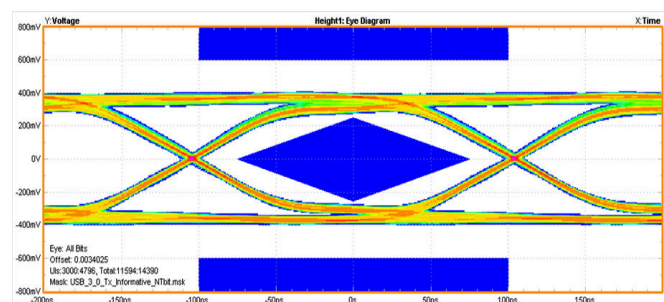
**Figure 8-3. Output Eye Diagram Without TPD2EUSB30/A (Figure 8-2 Setup, 5 Gbps Data Rate)**



**Figure 8-4. Output Eye Diagram With the TPD2EUSB30/A (Figure 8-2 Setup, 5 Gbps Data Rate)**



**Figure 8-5. Output Eye Diagram Without the TPD4EUSB30 (5 Gbps Data Rate)**



**Figure 8-6. Output Eye Diagram with the TPD4EUSB30 (5 Gbps Data Rate)**

## 9 Power Supply Recommendations

This family of devices are passive ESD protection devices and there is no need to power them. Care should be taken to not violate the maximum voltage specification to ensure that the device functions properly. The D+ and D– lines share a TVS diode which can tolerate up to 6 V.

## 10 Layout

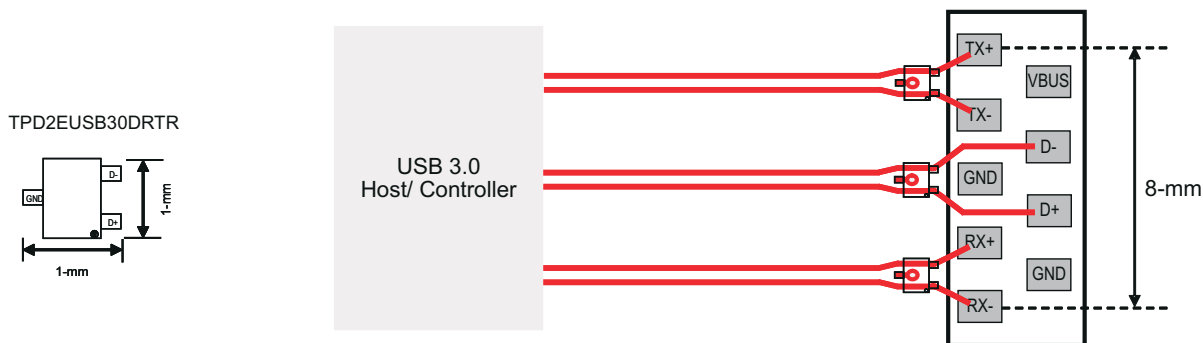
### 10.1 Layout Guidelines

- The optimum placement is as close to the connector as possible.
  - EMI during an ESD event can couple from the trace being struck to other nearby unprotected traces, resulting in early system failures.
  - The PCB designer needs to minimize the possibility of EMI coupling by keeping any unprotected traces away from the protected traces which are between the TVS and the connector.
- Route the protected traces as straight as possible.
- Eliminate any sharp corners on the protected traces between the TVS and the connector by using rounded corners with the largest radii possible.
  - Electric fields tend to build up on corners, increasing EMI coupling.

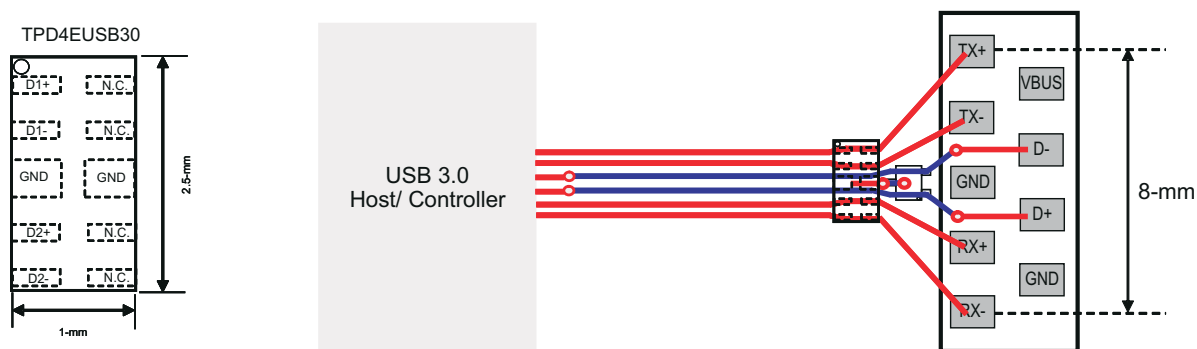
Refer to [Figure 10-1](#), the TPD2EUSB30/A are offered in space saving DRT package. The DRT is a 1-mm × 1-mm package with flow-through pin-mapping for the high-speed differential lines. The TPD4EUSB30 is offered in space saving DQA package. The DQA is a 1-mm × 2.5-mm package with flow-through pin-mapping for the high-speed differential lines. It is recommended to place the package right next to the USB 3.0 connector. The GND pin should be connected to GND plane of the board through a large VIA. If a dedicated GND plane is not present right underneath, it is recommended to route to the GND plane through a wide trace. The current associated with IEC ESD stress can be in the range of 30Amps or higher momentarily. A good, low impedance GND path ensures the system robustness against IEC ESD stress.

The TPDxEUSB30/A can provide system level ESD protection to the high-speed differential ports (> 5 Gbps data rate). The flow-through package offers flexibility for board routing with traces up to 15 mils wide. It allows the differential signal pairs couple together right after they touch the ESD ports of the TPDxEUSB30/A.

## 10.2 Layout Examples



Three TPD2EUSB30 to Protect USB3.0 Class A connector (One Layer Routing)



One TPD4EUSB30 & One TPD2EUSB30 to Protect USB3.0 Class A connector (Two Layer Routing)

**Figure 10-1. TPDxUSB30/A at the USB3.0 Class A Connector**

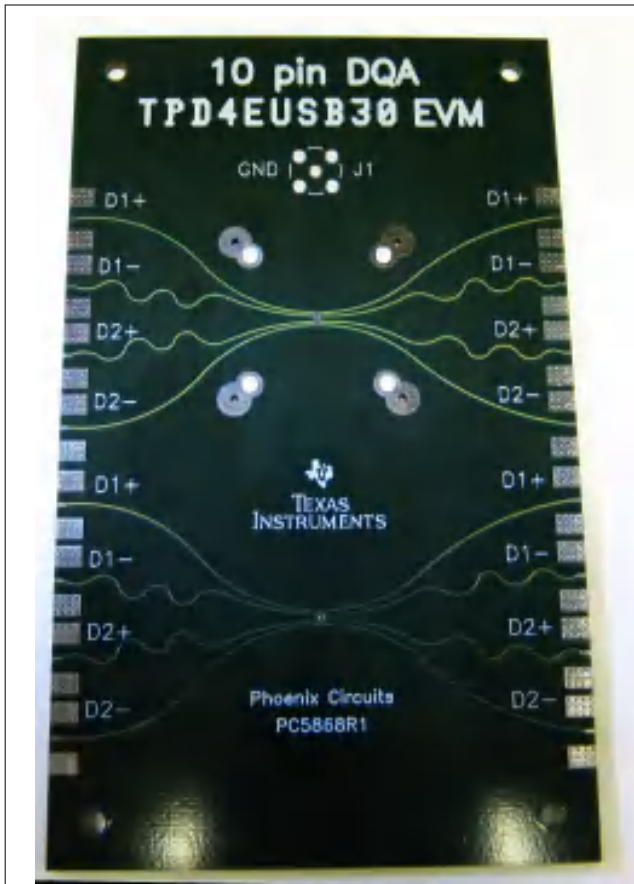


Figure 10-2. TPDxUSB30/A EVM – TPD4EUSB30 Side

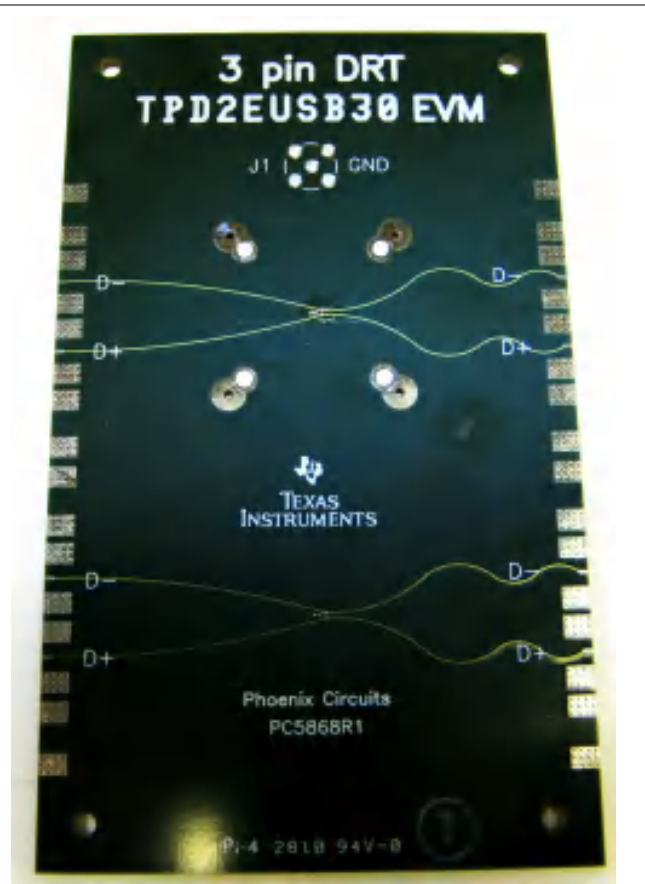


Figure 10-3. TPDxUSB30/A EVM – TPD2EUSB30/A Side

## 11 Device and Documentation Support

### 11.1 Receiving Notification of Documentation Updates

To receive notification of documentation updates, navigate to the device product folder on [ti.com](http://ti.com). Click on *Subscribe to updates* to register and receive a weekly digest of any product information that has changed. For change details, review the revision history included in any revised document.

### 11.2 Support Resources

TI E2E™ [support forums](#) are an engineer's go-to source for fast, verified answers and design help — straight from the experts. Search existing answers or ask your own question to get the quick design help you need.

Linked content is provided "AS IS" by the respective contributors. They do not constitute TI specifications and do not necessarily reflect TI's views; see TI's [Terms of Use](#).

### 11.3 Trademarks

TI E2E™ is a trademark of Texas Instruments.  
All trademarks are the property of their respective owners.

### 11.4 Electrostatic Discharge Caution



This integrated circuit can be damaged by ESD. Texas Instruments recommends that all integrated circuits be handled with appropriate precautions. Failure to observe proper handling and installation procedures can cause damage.

ESD damage can range from subtle performance degradation to complete device failure. Precision integrated circuits may be more susceptible to damage because very small parametric changes could cause the device not to meet its published specifications.

### 11.5 Glossary

[TI Glossary](#) This glossary lists and explains terms, acronyms, and definitions.

## 12 Mechanical, Packaging, and Orderable Information

The following pages include mechanical, packaging, and orderable information. This information is the most current data available for the designated devices. This data is subject to change without notice and revision of this document. For browser-based versions of this data sheet, refer to the left-hand navigation.

**PACKAGING INFORMATION**

Orderable Device	Status (1)	Package Type	Package Drawing	Pins	Package Qty	Eco Plan (2)	Lead finish/ Ball material (6)	MSL Peak Temp (3)	Op Temp (°C)	Device Marking (4/5)	Samples
TPD2EUSB30ADRTR	ACTIVE	SOT-9X3	DRT	3	3000	RoHS & Green	NIPDAU	Level-1-260C-UNLIM	-40 to 85	5S	<a href="#">Samples</a>
TPD2EUSB30DRTR	ACTIVE	SOT-9X3	DRT	3	3000	RoHS & Green	NIPDAU	Level-1-260C-UNLIM	-40 to 85	5P	<a href="#">Samples</a>
TPD4EUSB30DQAR	ACTIVE	USON	DQA	10	3000	RoHS & Green	NIPDAU   NIPDAUAG	Level-1-260C-UNLIM	-40 to 85	(667, 66O, 66R, 66V, BMR)	<a href="#">Samples</a>

(1) The marketing status values are defined as follows:

**ACTIVE:** Product device recommended for new designs.

**LIFEBUY:** TI has announced that the device will be discontinued, and a lifetime-buy period is in effect.

**NRND:** Not recommended for new designs. Device is in production to support existing customers, but TI does not recommend using this part in a new design.

**PREVIEW:** Device has been announced but is not in production. Samples may or may not be available.

**OBSOLETE:** TI has discontinued the production of the device.

(2) **RoHS:** TI defines "RoHS" to mean semiconductor products that are compliant with the current EU RoHS requirements for all 10 RoHS substances, including the requirement that RoHS substance do not exceed 0.1% by weight in homogeneous materials. Where designed to be soldered at high temperatures, "RoHS" products are suitable for use in specified lead-free processes. TI may reference these types of products as "Pb-Free".

**RoHS Exempt:** TI defines "RoHS Exempt" to mean products that contain lead but are compliant with EU RoHS pursuant to a specific EU RoHS exemption.

**Green:** TI defines "Green" to mean the content of Chlorine (Cl) and Bromine (Br) based flame retardants meet JS709B low halogen requirements of <=1000ppm threshold. Antimony trioxide based flame retardants must also meet the <=1000ppm threshold requirement.

(3) MSL, Peak Temp. - The Moisture Sensitivity Level rating according to the JEDEC industry standard classifications, and peak solder temperature.

(4) There may be additional marking, which relates to the logo, the lot trace code information, or the environmental category on the device.

(5) Multiple Device Markings will be inside parentheses. Only one Device Marking contained in parentheses and separated by a "~" will appear on a device. If a line is indented then it is a continuation of the previous line and the two combined represent the entire Device Marking for that device.

(6) Lead finish/Ball material - Orderable Devices may have multiple material finish options. Finish options are separated by a vertical ruled line. Lead finish/Ball material values may wrap to two lines if the finish value exceeds the maximum column width.

**Important Information and Disclaimer:**The information provided on this page represents TI's knowledge and belief as of the date that it is provided. TI bases its knowledge and belief on information provided by third parties, and makes no representation or warranty as to the accuracy of such information. Efforts are underway to better integrate information from third parties. TI has taken and continues to take reasonable steps to provide representative and accurate information but may not have conducted destructive testing or chemical analysis on incoming materials and chemicals. TI and TI suppliers consider certain information to be proprietary, and thus CAS numbers and other limited information may not be available for release.

In no event shall TI's liability arising out of such information exceed the total purchase price of the TI part(s) at issue in this document sold by TI to Customer on an annual basis.



**TAPE AND REEL INFORMATION**

**QUADRANT ASSIGNMENTS FOR PIN 1 ORIENTATION IN TAPE**


\*All dimensions are nominal

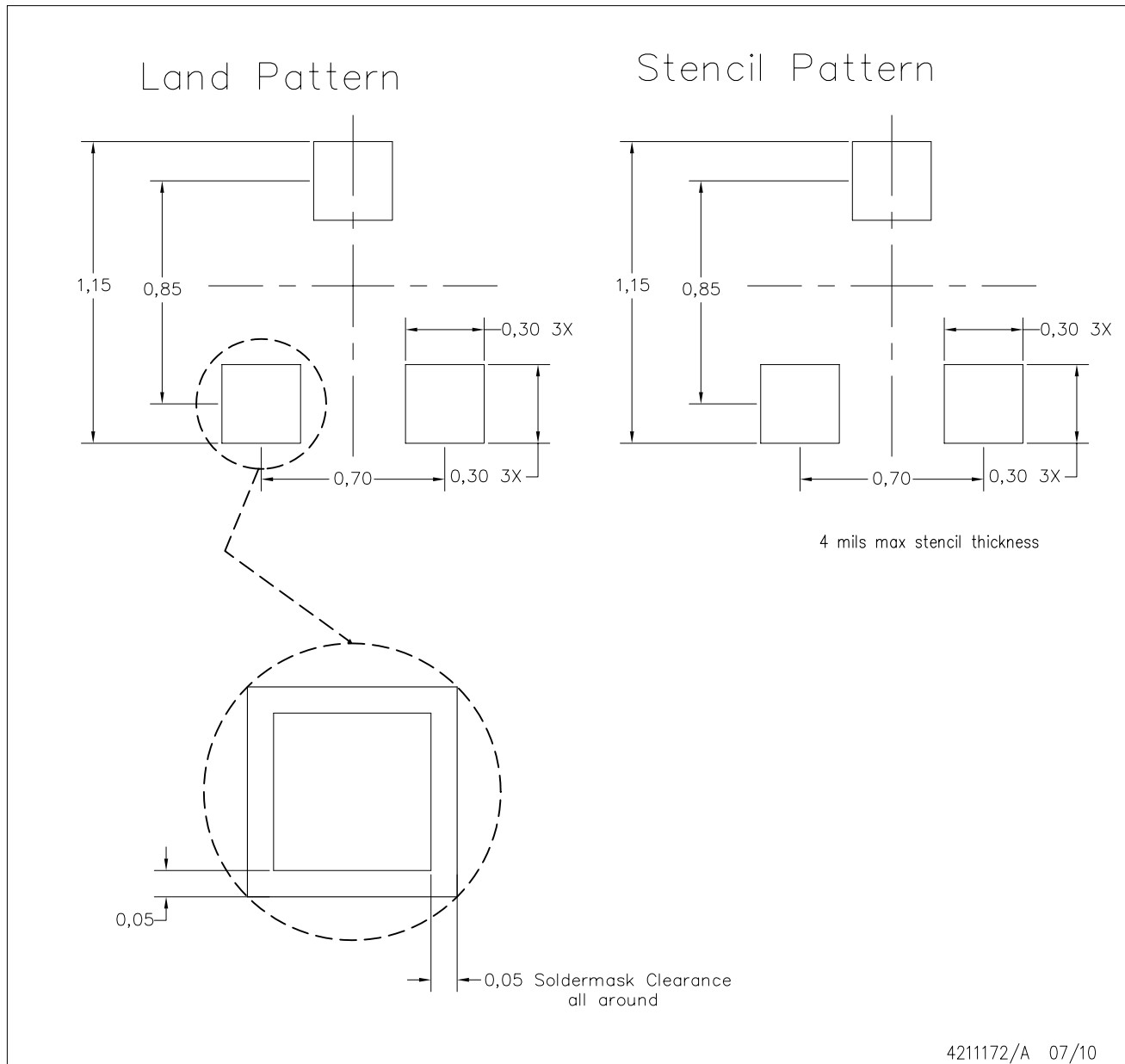
Device	Package Type	Package Drawing	Pins	SPQ	Reel Diameter (mm)	Reel Width W1 (mm)	A0 (mm)	B0 (mm)	K0 (mm)	P1 (mm)	W (mm)	Pin1 Quadrant
TPD2EUSB30ADRTR	SOT-9X3	DRT	3	3000	180.0	8.4	1.16	1.16	0.63	4.0	8.0	Q3
TPD2EUSB30DRTR	SOT-9X3	DRT	3	3000	180.0	8.4	1.16	1.16	0.63	4.0	8.0	Q3
TPD4EUSB30DQAR	USON	DQA	10	3000	180.0	9.5	1.23	2.7	0.7	4.0	8.0	Q1
TPD4EUSB30DQAR	USON	DQA	10	3000	180.0	9.5	1.18	2.68	0.72	4.0	8.0	Q1

**TAPE AND REEL BOX DIMENSIONS**


\*All dimensions are nominal

Device	Package Type	Package Drawing	Pins	SPQ	Length (mm)	Width (mm)	Height (mm)
TPD2EUSB30ADRTR	SOT-9X3	DRT	3	3000	183.0	183.0	20.0
TPD2EUSB30DRTR	SOT-9X3	DRT	3	3000	183.0	183.0	20.0
TPD4EUSB30DQAR	USON	DQA	10	3000	184.0	184.0	19.0
TPD4EUSB30DQAR	USON	DQA	10	3000	189.0	185.0	36.0





- NOTES:
- All linear dimensions are in millimeters.
  - This drawing is subject to change without notice.
  - Publication IPC-7351 is recommended for alternate designs.
  - Customers should contact their board fabrication site for minimum solder mask web tolerances between signal pads.
  - Maximum stencil thickness 0,1016 mm (4 mils). All linear dimensions are in millimeters.
  - Laser cutting apertures with trapezoidal walls and also rounding corners will offer better paste release. Customers should contact their board assembly site for stencil design recommendations. Refer to IPC 7525 for stencil design considerations.
  - Side aperture dimensions over-print land for acceptable area ratio > 0.66. Customer may reduce side aperture dimensions if stencil manufacturing process allows for sufficient release at smaller opening.

## GENERIC PACKAGE VIEW

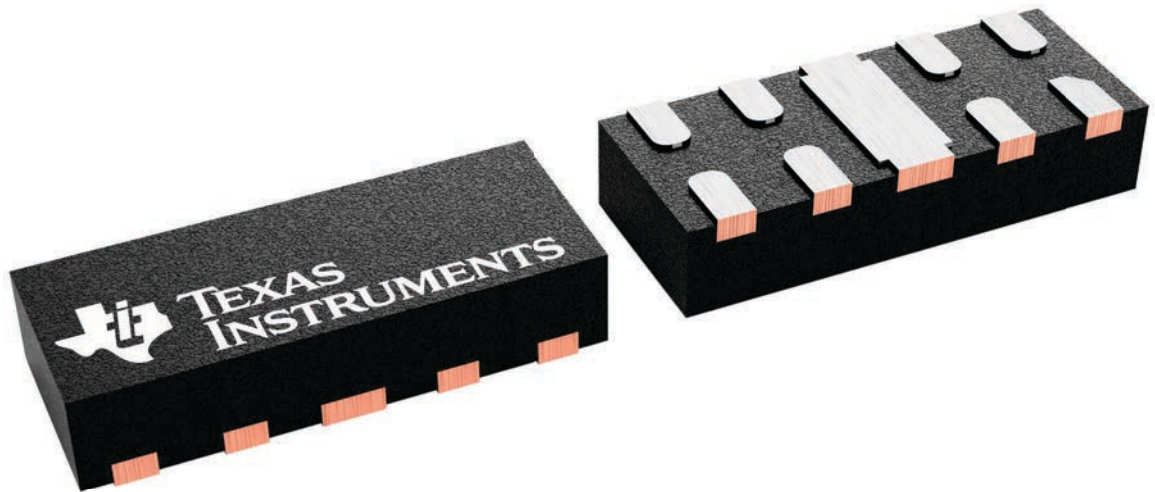
**DQA 10**

**USON - 0.55 mm max height**

1 x 2.5, 0.5 mm pitch

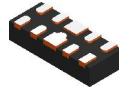
PLASTIC SMALL OUTLINE - NO LEAD

This image is a representation of the package family, actual package may vary.  
Refer to the product data sheet for package details.



4230320/A

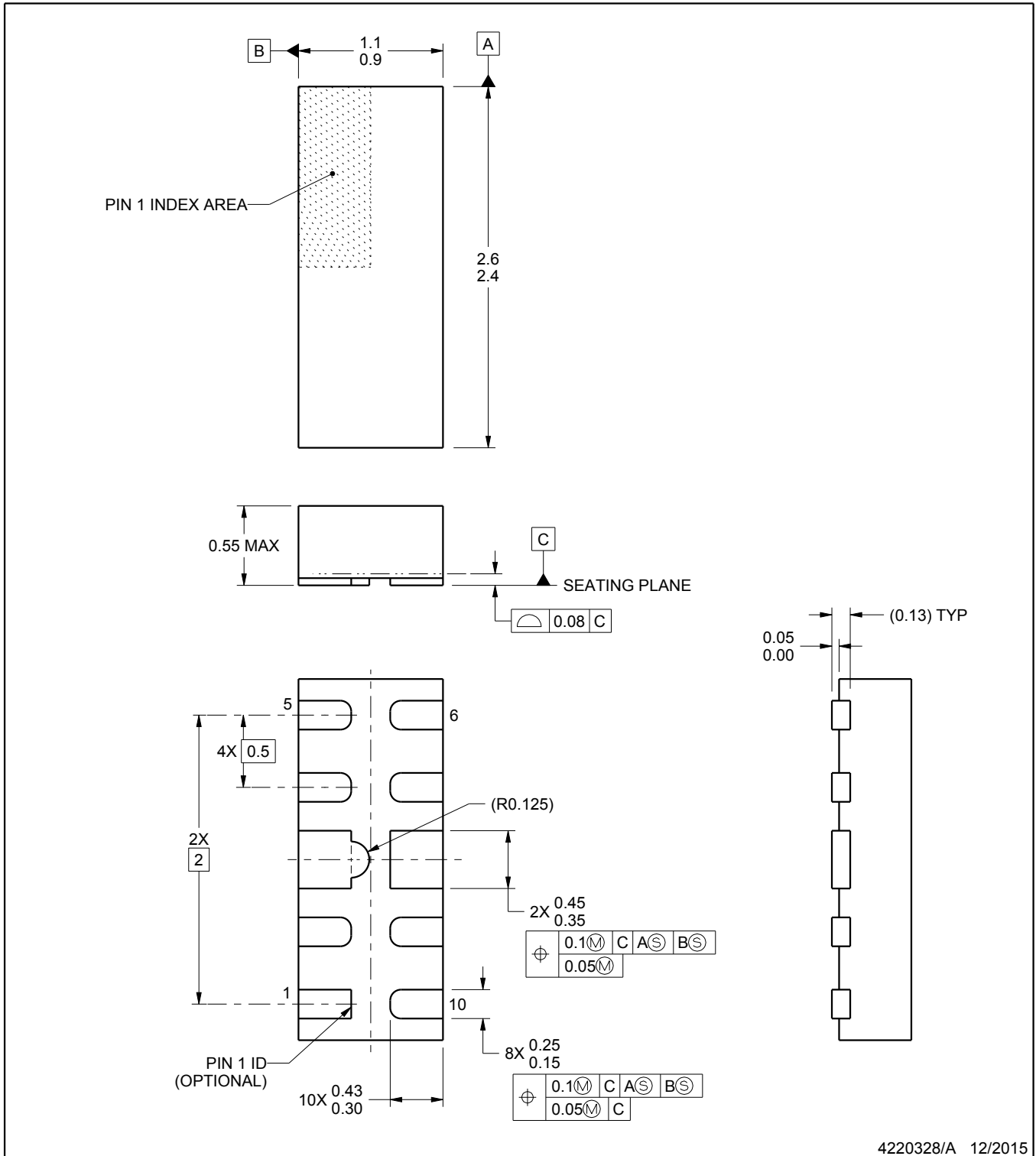
# DQA0010A



## PACKAGE OUTLINE

USON - 0.55 mm max height

PLASTIC SMALL OUTLINE - NO LEAD



4220328/A 12/2015

**NOTES:**

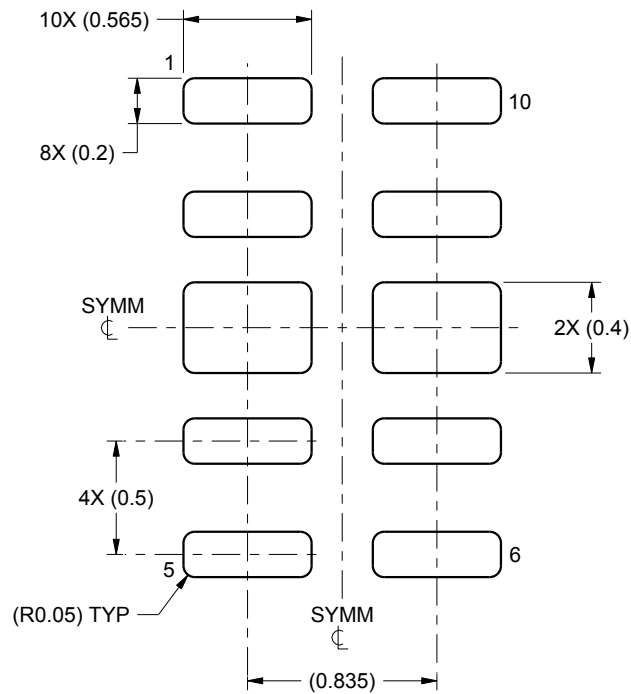
1. All linear dimensions are in millimeters. Any dimensions in parenthesis are for reference only. Dimensioning and tolerancing per ASME Y14.5M.
2. This drawing is subject to change without notice.

# EXAMPLE BOARD LAYOUT

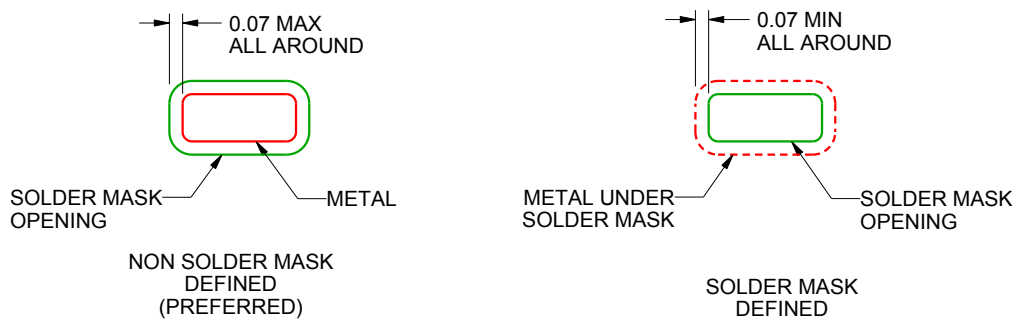
DQA0010A

USON - 0.55 mm max height

PLASTIC SMALL OUTLINE - NO LEAD



LAND PATTERN EXAMPLE  
SCALE:30X



SOLDER MASK DETAILS

4220328/A 12/2015

NOTES: (continued)

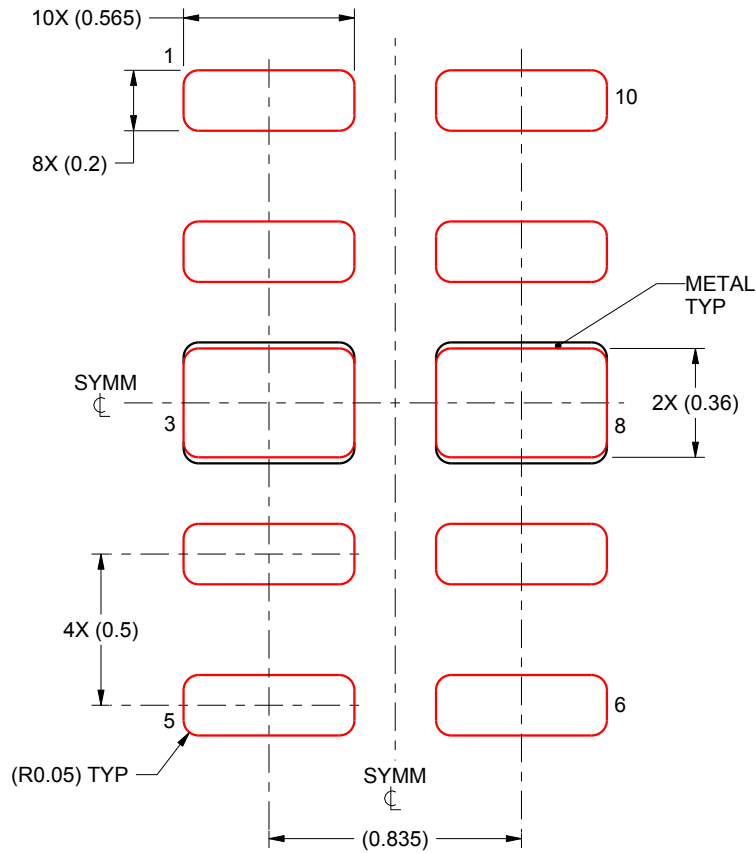
3. For more information, see Texas Instruments literature number SLUA271 ([www.ti.com/lit/slua271](http://www.ti.com/lit/slua271)).

# EXAMPLE STENCIL DESIGN

DQA0010A

USON - 0.55 mm max height

PLASTIC SMALL OUTLINE - NO LEAD



SOLDER PASTE EXAMPLE  
BASED ON 0.1 mm THICK STENCIL

EXPOSED PADS 3 & 8:  
90% PRINTED SOLDER COVERAGE BY AREA UNDER PACKAGE  
SCALE:40X

4220328/A 12/2015

NOTES: (continued)

4. Laser cutting apertures with trapezoidal walls and rounded corners may offer better paste release. IPC-7525 may have alternate design recommendations.



## IMPORTANT NOTICE AND DISCLAIMER

TI PROVIDES TECHNICAL AND RELIABILITY DATA (INCLUDING DATA SHEETS), DESIGN RESOURCES (INCLUDING REFERENCE DESIGNS), APPLICATION OR OTHER DESIGN ADVICE, WEB TOOLS, SAFETY INFORMATION, AND OTHER RESOURCES "AS IS" AND WITH ALL FAULTS, AND DISCLAIMS ALL WARRANTIES, EXPRESS AND IMPLIED, INCLUDING WITHOUT LIMITATION ANY IMPLIED WARRANTIES OF MERCHANTABILITY, FITNESS FOR A PARTICULAR PURPOSE OR NON-INFRINGEMENT OF THIRD PARTY INTELLECTUAL PROPERTY RIGHTS.

These resources are intended for skilled developers designing with TI products. You are solely responsible for (1) selecting the appropriate TI products for your application, (2) designing, validating and testing your application, and (3) ensuring your application meets applicable standards, and any other safety, security, regulatory or other requirements.

These resources are subject to change without notice. TI grants you permission to use these resources only for development of an application that uses the TI products described in the resource. Other reproduction and display of these resources is prohibited. No license is granted to any other TI intellectual property right or to any third party intellectual property right. TI disclaims responsibility for, and you will fully indemnify TI and its representatives against, any claims, damages, costs, losses, and liabilities arising out of your use of these resources.

TI's products are provided subject to [TI's Terms of Sale](#) or other applicable terms available either on [ti.com](https://www.ti.com) or provided in conjunction with such TI products. TI's provision of these resources does not expand or otherwise alter TI's applicable warranties or warranty disclaimers for TI products.

TI objects to and rejects any additional or different terms you may have proposed.

Mailing Address: Texas Instruments, Post Office Box 655303, Dallas, Texas 75265  
Copyright © 2023, Texas Instruments Incorporated