

CLASS V 2x2 LVDS CROSSPOINT SWITCH

 Check for Samples: [SN55LVCP22-SP](#)

FEATURES

- High Speed (>1000 Mbps) Upgrade for DS90CP22 2x2 LVDS Crosspoint Switch
- Low-Jitter Fully Differential Data Path
- 50 ps (Typ), of Peak-to-Peak Jitter With PRBS = $2^{23}-1$ Pattern
- Less Than 200 mW (Typ), 300 mW (Max) Total Power Dissipation
- Output (Channel-to-Channel) Skew Is 80 ps (Typ)
- Configurable as 2:1 Mux, 1:2 Demux, Repeater or 1:2 Signal Splitter
- Inputs Accept LVDS, LVPECL, and CML Signals
- Fast Switch Time of 1.7 ns (Typ)
- Fast Propagation Delay of 0.65 ns (Typ)
- Available in 16 pin CFP Package
- Inter-Operates With TIA/EIA-644-A LVDS Standard
- Military Temperature Range: -55°C to 125°C

APPLICATIONS

- Base Stations
- Add/Drop Muxes
- Protection Switching for Serial Backplanes
- Network Switches/Routers
- Optical Networking Line Cards/Switches
- Clock Distribution
- Engineering Evaluation (/EM) Samples are Available ⁽¹⁾

- (1) These units are intended for engineering evaluation only. They are processed to a non-compliant flow (e.g. no burn-in, etc.) and are tested to temperature rating of 25°C only. These units are not suitable for qualification, production, radiation testing or flight use. Parts are not warranted for performance on full MIL specified temperature range of -55°C to 125°C or operating life.

DESCRIPTION

The SN55LVCP22 is a 2x2 crosspoint switch providing greater than 1000 Mbps operation for each path. The dual channels incorporate wide common-mode (0 V to 4 V) receivers, allowing for the receipt of LVDS, LVPECL, and CML signals. The dual outputs are LVDS drivers to provide low-power, low-EMI, high-speed operation. The SN55LVCP22 provides a single device supporting 2:2 buffering (repeating), 1:2 splitting, 2:1 multiplexing, 2x2 switching, and LVPECL/CML to LVDS level translation on each channel. The flexible operation of the SN55LVCP22 provides a single device to support the redundant serial bus transmission needs (working and protection switching cards) of fault-tolerant switch systems found in optical networking, wireless infrastructure, and data communications systems. TI offers additional gigabit repeater/ translator and crosspoint products in the SN65LVDS100 and SN65LVDS122.

The SN55LVCP22 uses a fully differential data path to ensure low-noise generation, fast switching times, low pulse width distortion, and low jitter. Output channel-to-channel skew is 80 ps (typ) to ensure accurate alignment of outputs in all applications. Both SOIC and TSSOP package options are available to allow easy upgrade for existing solutions, and board area savings where space is critical.

OUTPUTS OPERATING SIMULTANEOUSLY

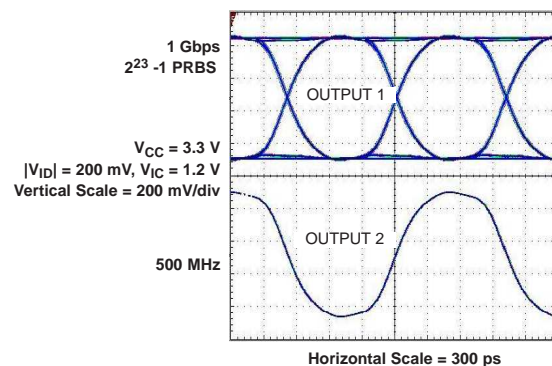

Please be aware that an important notice concerning availability, standard warranty, and use in critical applications of Texas Instruments semiconductor products and disclaimers thereto appears at the end of this data sheet.

SN55LVCP22-SP

SLLSE43A – JUNE 2012 – REVISED JANUARY 2014

www.ti.com



This integrated circuit can be damaged by ESD. Texas Instruments recommends that all integrated circuits be handled with appropriate precautions. Failure to observe proper handling and installation procedures can cause damage.

ESD damage can range from subtle performance degradation to complete device failure. Precision integrated circuits may be more susceptible to damage because very small parametric changes could cause the device not to meet its published specifications.

THERMAL CHARACTERISTICS

PARAMETER		TEST CONDITIONS		VALUE	UNITS
θ_{JA}	Junction-to-ambient thermal resistance			82.5	°C/W
θ_{JC}	Junction-to-case thermal resistance			7.5	°C/W
P_D	Device power dissipation	Typical	$V_{CC} = 3.3\text{ V}, T_A = 25^\circ\text{C}, 1\text{ Gbps}$	198	mW
		Maximum	$V_{CC} = 3.6\text{ V}, T_A = 125^\circ\text{C}, 1\text{ Gbps}$	313	

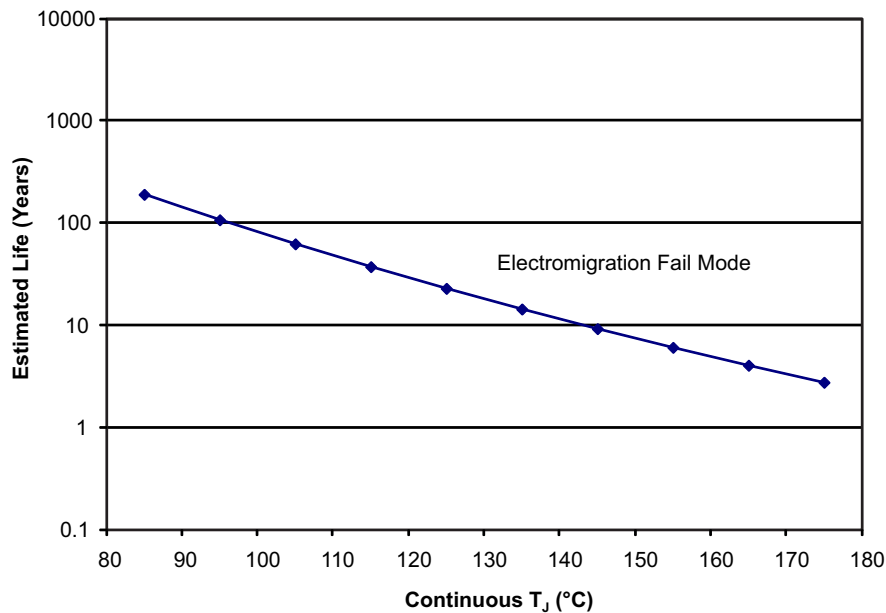

- A. See datasheet for absolute maximum and minimum recommended operating conditions.
- B. Silicon operating life design goal is 10 years at 105°C junction temperature (does not include package interconnect life).
- C. The predicted operating lifetime vs. junction temperature is based on reliability modeling using electromigration as the dominant failure mechanism affecting device wearout for the specific device process and design characteristics.

Figure 1. SN55LVCP22-SP Operating Life Derating Chart

Table 1. FUNCTION TABLE

SEL0	SEL1	OUT0	OUT1	FUNCTION
0	0	IN0	IN0	1:2 Splitter
0	1	IN0	IN1	Repeater
1	0	IN1	IN0	Switch
1	1	IN1	IN1	1:2 Splitter

FUNCTIONAL BLOCK DIAGRAM

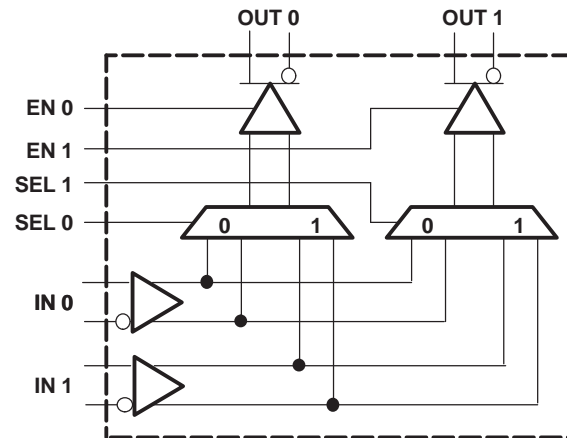

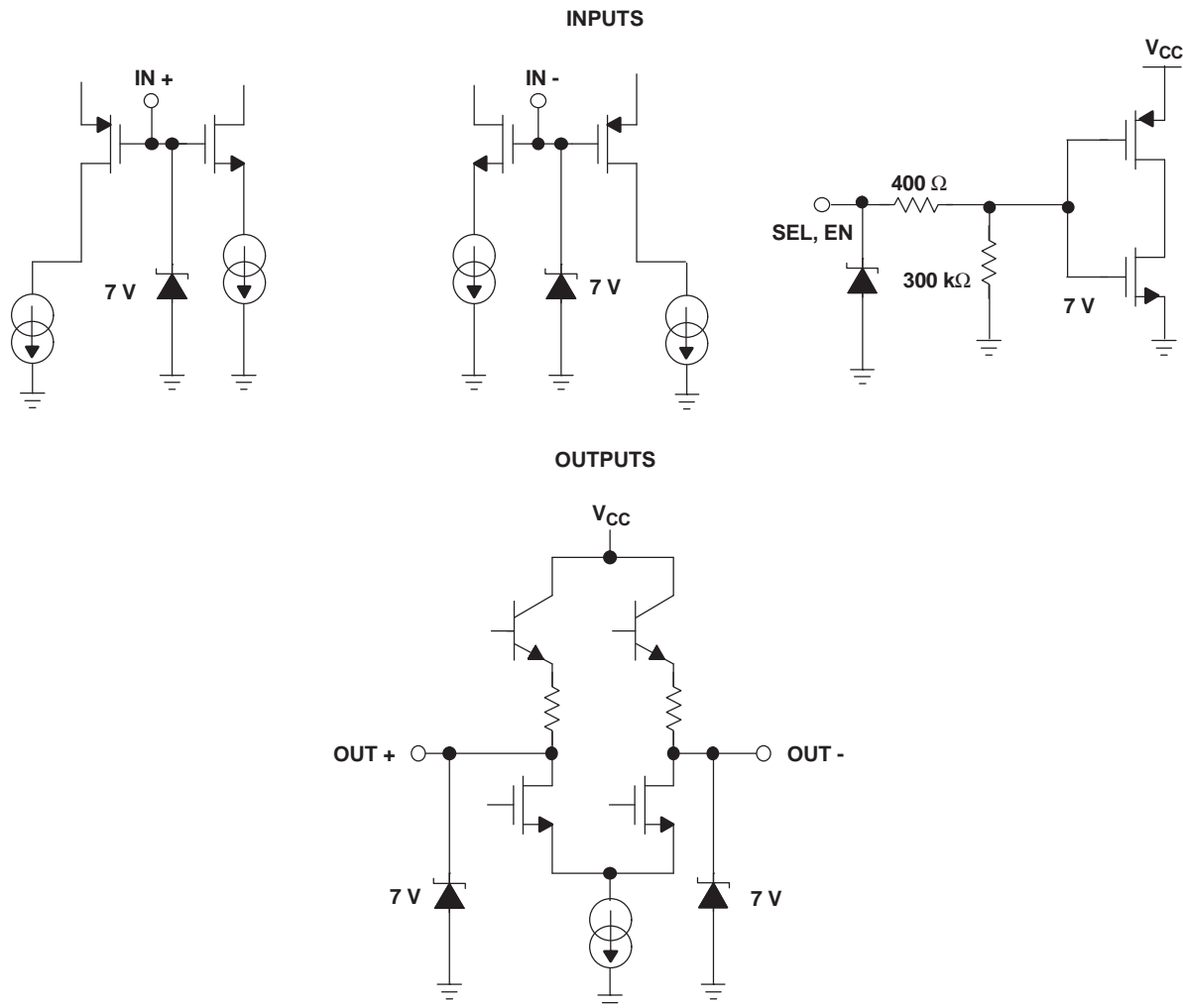
EQUIVALENT INPUT AND OUTPUT SCHEMATIC DIAGRAMS

ABSOLUTE MAXIMUM RATINGS

 over operating free-air temperature range unless otherwise noted⁽¹⁾

		UNITS
Supply voltage ⁽²⁾ range, V_{CC}		–0.5 V to 4 V
CMOS/TTL input voltage (ENO, EN1, SEL0, SEL1)		–0.5 V to 4 V
LVDS receiver input voltage (IN+, IN–)		–0.7 V to 4.3 V
LVDS driver output voltage (OUT+, OUT–)		–0.5 V to 4 V
LVDS output short circuit current		Continuous
Storage temperature range		–65°C to 125°C
Maximum Junction temperature		150°C
Electrostatic discharge	Human body model ⁽³⁾	All pins ±5 kV
	Charged-device mode ⁽⁴⁾	All pins ±500 V

- (1) Stresses beyond those listed under *absolute maximum ratings* may cause permanent damage to the device. These are stress ratings only, and functional operation of the device at these or any other conditions beyond those indicated under *recommended operating conditions* is not implied. Exposure to absolute-maximum-rated conditions for extended periods may affect device reliability.
- (2) All voltage values, except differential I/O bus voltages, are with respect to network ground terminals.
- (3) Tested in accordance with JEDEC Standard 22, Test Method A114-A.
- (4) Tested in accordance with JEDEC Standard 22, Test Method C101.

RECOMMENDED OPERATING CONDITIONS

	MIN	NOM	MAX	UNIT
Supply voltage, V_{CC}	3	3.3	3.6	V
Receiver input voltage	0		4	V
Operating Case Temperature range, T_C ⁽¹⁾	-55		125	°C
Magnitude of differential input voltage $ V_{ID} $	0.1		3	V

(1) Maximum case temperature operation is allowed as long as the device maximum junction temperature is not exceeded.

INPUT ELECTRICAL CHARACTERISTICS

over recommended operating conditions unless otherwise noted

PARAMETER	TEST CONDITIONS	MIN	TYP ⁽¹⁾	MAX	UNIT
CMOS/TTL DC SPECIFICATIONS (EN0, EN1, SEL0, SEL1)					
V_{IH} High-level input voltage		2		V_{CC}	V
V_{IL} Low-level input voltage		GND		0.8	V
I_{IH} High-level input current	$V_{IN} = 3.6\text{ V or }2.0\text{ V}, V_{CC} = 3.6\text{ V}$	-25	±3	25	µA
I_{IL} Low-level input current	$V_{IN} = 0.0\text{ V or }0.8\text{ V}, V_{CC} = 3.6\text{ V}$	-15	±1	15	µA
V_{CL} Input clamp voltage	$I_{CL} = -18\text{ mA}$		-0.8	-1.5	V
LVDS OUTPUT SPECIFICATIONS (OUT0, OUT1)					
$ V_{OD} $ Differential output voltage	$R_L = 75\ \Omega$, See Figure 3	255	365	475	mV
	$R_L = 75\ \Omega$, $V_{CC} = 3.3\text{ V}$, $T_A = 25^\circ\text{C}$, See Figure 3	285	365	440	
$\Delta V_{OD} $ Change in differential output voltage magnitude between logic states	$V_{ID} = \pm 100\text{ mV}$, See Figure 3	-25		25	mV
V_{OS} Steady-state offset voltage	See Figure 4	1	1.2	1.45	V
ΔV_{OS} Change in steady-state offset voltage between logic states	See Figure 4	-25		25	mV
$V_{OC(PP)}$ Peak-to-peak common-mode output voltage	See Figure 4		50		mV
I_{OZ} High-impedance output current	$V_{OUT} = \text{GND or } V_{CC}$	-15		15	µA
I_{OFF} Power-off leakage current	$V_{CC} = 0\text{ V}, 1.5\text{ V}; V_{OUT} = 3.6\text{ V or GND}$	-15		15	µA
I_{OS} Output short-circuit current	V_{OUT+} or $V_{OUT-} = 0\text{ V}$			-8	mA
I_{OSB} Both outputs short-circuit current	V_{OUT+} and $V_{OUT-} = 0\text{ V}$	-8		8	mA
C_O Differential output capacitance	$V_I = 0.4 \sin(4E6\pi t) + 0.5\text{ V}$		3		pF
LVDS RECEIVER DC SPECIFICATIONS (IN0, IN1)					
V_{TH} Positive-going differential input voltage threshold	See Figure 2 and Table 2			100	mV
V_{TL} Negative-going differential input voltage threshold	See Figure 2 and Table 2	-100			mV
$V_{ID(HYS)}$ Differential input voltage hysteresis			25	150	mV
V_{CMR} Common-mode voltage range	$V_{ID} = 100\text{ mV}, V_{CC} = 3.0\text{ V to }3.6\text{ V}$	0.05		3.95	V
I_{IN} Input current	$V_{IN} = 4\text{ V}, V_{CC} = 3.6\text{ V or }0.0$	-18	±1	18	µA
	$V_{IN} = 0\text{ V}, V_{CC} = 3.6\text{ V or }0.0$	-18	±1	18	
C_{IN} Differential input capacitance	$V_I = 0.4 \sin(4E6\pi t) + 0.5\text{ V}$		3		pF
SUPPLY CURRENT					
I_{CCQ} Quiescent supply current	$R_L = 75\ \Omega$, EN0=EN1=High		60	87	mA
I_{CCD} Total supply current	$R_L = 75\ \Omega$, $C_L = 5\text{ pF}$, 500 MHz (1000 Mbps), EN0=EN1=High		63	87	mA
I_{CCZ} 3-state supply current	EN0 = EN1 = Low		25	35	mA

(1) All typical values are at 25°C and with a 3.3-V supply.

SN55LVCP22-SP

SLLSE43A – JUNE 2012 – REVISED JANUARY 2014

www.ti.com

SWITCHING CHARACTERISTICS

over recommended operating conditions unless otherwise noted

parameter		TEST CONDITIONS	MIN	TYP	MAX	UNIT
t_{SET}	Input to SEL setup time	See Figure 7	2.2	0.8		ns
t_{HOLD}	Input to SEL hold time	See Figure 7	2.2	1.0		ns
t_{SWITCH}	SEL to switched output	See Figure 7		1.7	2.6	ns
t_{PHZ}	Disable time, high-level-to-high-impedance	See Figure 6		2	8	ns
t_{PLZ}	Disable time, low-level-to-high-impedance	See Figure 6		2	8	ns
t_{PZH}	Enable time, high-impedance -to-high-level output	See Figure 6		2	8	ns
t_{PZL}	Enable time, high-impedance-to-low-level output	See Figure 6		2	8	ns
t_{LHT}	Differential output signal rise time (20%-80%) ⁽¹⁾	$C_L = 5$ pF, See Figure 5		280	620	ps
t_{HLT}	Differential output signal fall time (20%-80%) ⁽¹⁾	$C_L = 5$ pF, See Figure 5		280	620	ps
t_{JIT}	Added peak-to-peak jitter	$V_{ID} = 200$ mV, 50% duty cycle, $V_{CM} = 1.2$ V, 50 MHz, $C_L = 5$ pF		13.7	22.2	ps
		$V_{ID} = 200$ mV, 50% duty cycle, $V_{CM} = 1.2$ V, 240 MHz, $C_L = 5$ pF		13.4	24.5	
		$V_{ID} = 200$ mV, 50% duty cycle, $V_{CM} = 1.2$ V, 500 MHz, $C_L = 5$ pF		14.4	35.7	
		$V_{ID} = 200$ mV, PRBS = $2^{15}-1$ data pattern, $V_{CM} = 1.2$ V, 240 Mbps, $C_L = 5$ pF		68.3	204	ps
		$V_{ID} = 200$ mV, PRBS = $2^{15}-1$ data pattern, $V_{CM} = 1.2$ V, 1000 Mbps, $C_L = 5$ pF		73.2	282	
t_{Jrms}	Added random jitter (rms)	$V_{ID} = 200$ mV, 50% duty cycle, $V_{CM} = 1.2$ V, 50 MHz, $C_L = 5$ pF		0.97	1.5	ps _{RMS}
		$V_{ID} = 200$ mV, 50% duty cycle, $V_{CM} = 1.2$ V, 240 MHz, $C_L = 5$ pF		0.85	1.53	
		$V_{ID} = 200$ mV, 50% duty cycle, $V_{CM} = 1.2$ V, 500 MHz, $C_L = 5$ pF		0.86	1.79	
t_{PLHD}	Propagation delay time, low-to-high-level output ⁽¹⁾		200	650	2350	ps
t_{PHLD}	Propagation delay time, high-to-low-level output ⁽¹⁾		200	650	2350	ps
$t_{skew}^{(2)}$	Pulse skew ($ t_{PLHD} - t_{PHLD} $) ⁽³⁾	$C_L = 5$ pF, See Figure 5		45	160	ps
t_{CCS}	Output channel-to-channel skew, splitter mode	$C_L = 5$ pF, See Figure 5		80		ps
$f_{MAX}^{(2)}$	Maximum operating frequency ⁽⁴⁾		1			GHz

(1) Input: $V_{IC} = 1.2$ V, $V_{ID} = 200$ mV, 50% duty cycle, 1 MHz, $t_r/t_f = 500$ ps

(2) t_{skew} and f_{MAX} parameters are guaranteed by characterization, but not production tested.

(3) t_{skew} is the magnitude of the time difference between the t_{PLHD} and t_{PHLD} of any output of a single device.

(4) Signal generator conditions: 50% duty cycle, t_r or $t_f \leq 100$ ps (10% to 90%), transmitter output criteria: duty cycle = 45% to 55% $V_{OD} \geq 300$ mV.

PIN ASSIGNMENTS

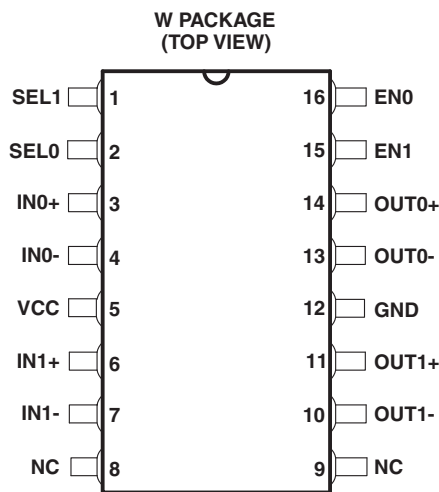

NC - No internal connection

PARAMETER MEASUREMENT INFORMATION

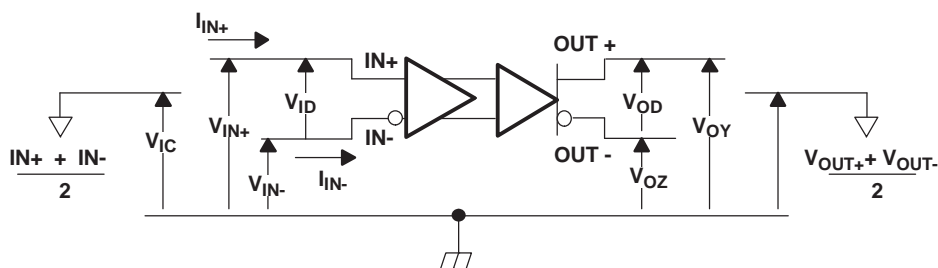

Figure 2. Voltage and Current Definitions

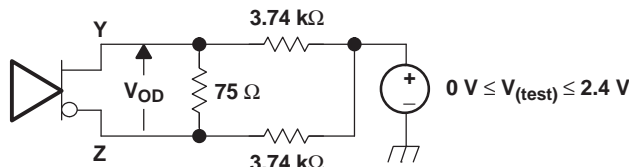
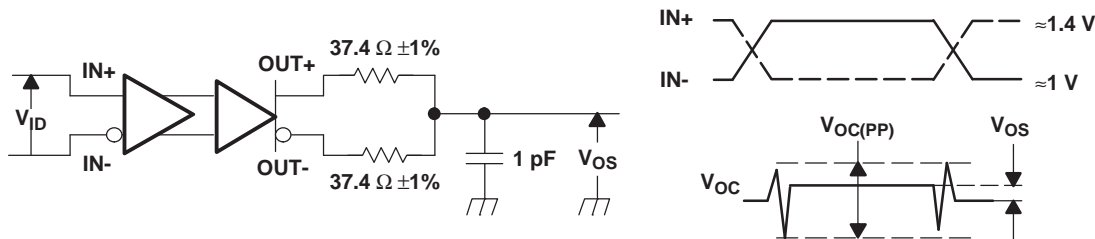

Figure 3. Differential Output Voltage (V_{OD}) Test Circuit



NOTE: All input pulses are supplied by a generator having the following characteristics: t_r or $t_f \leq 1$ ns, pulse-repetition rate (PRR) = 0.5 Mpps, pulse width = 500 ± 10 ns; $R_L = 100 \Omega$; C_L includes instrumentation and fixture capacitance within 0,06 mm of the D.U.T.; the measurement of $V_{OC(PP)}$ is made on test equipment with a -3 dB bandwidth of at least 300 MHz.

Figure 4. Test Circuit and Definitions for the Driver Common-Mode Output Voltage

PARAMETER MEASUREMENT INFORMATION (continued)

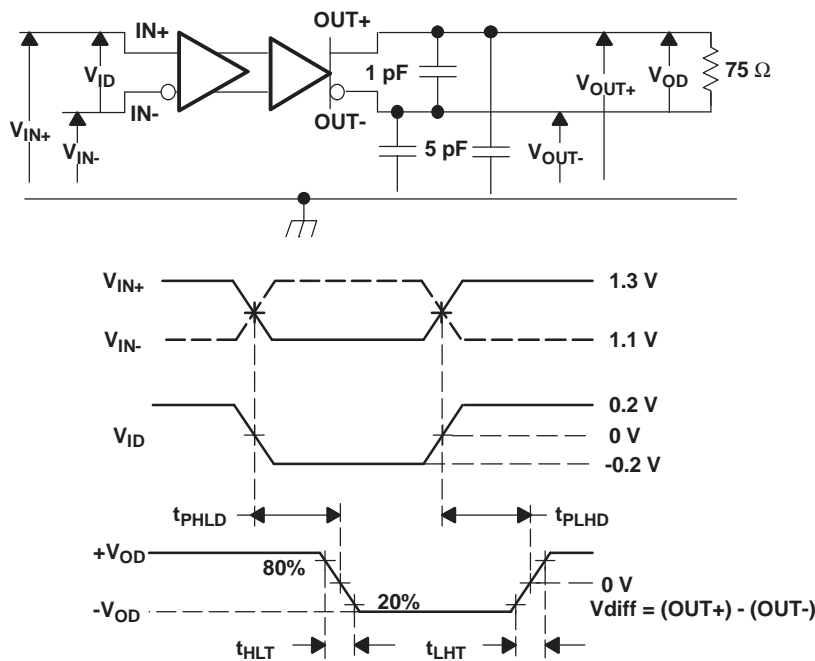

NOTE: All input pulses are supplied by a generator having the following characteristics: t_r or $t_f \leq .25$ ns, pulse-repetition rate (PRR) = 0.5 Mpps, pulse width = 500 ± 10 ns. C_L includes instrumentation and fixture capacitance within 0,06 mm of the D.U.T.

Figure 5. Timing Test Circuit and Waveforms

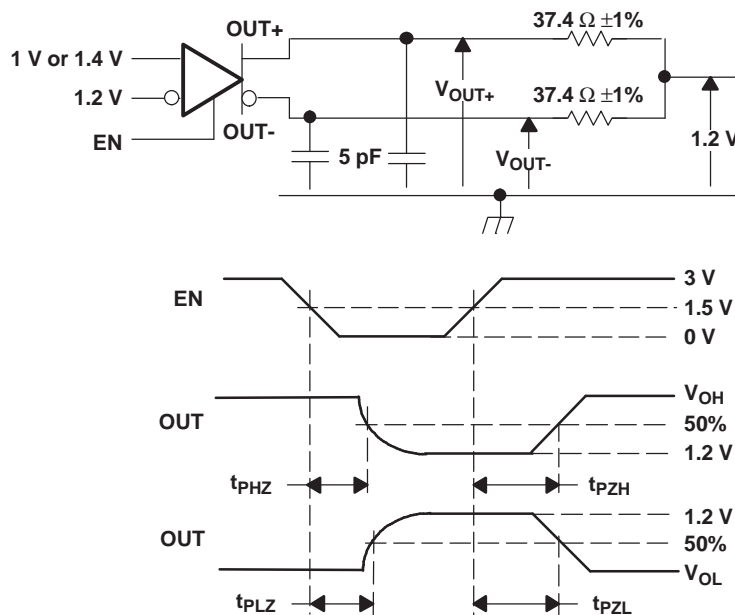

NOTE: All input pulses are supplied by a generator having the following characteristics: t_r or $t_f \leq 1$ ns, pulse-repetition rate (PRR) = 0.5 Mpps, pulse width = 500 ± 10 ns. C_L includes instrumentation and fixture capacitance within 0,06 mm of the D.U.T.

Figure 6. Enable and Disable Time Circuit and Definitions

Table 2. Receiver Input Voltage Threshold Test

APPLIED VOLTAGES		RESULTING DIFFERENTIAL INPUT VOLTAGE	RESULTING COMMON- MODE INPUT VOLTAGE	OUTPUT ⁽¹⁾
V _{IA}	V _{IB}	V _{ID}	V _{IC}	
1.25 V	1.15 V	100 mV	1.2 V	H
1.15 V	1.25 V	-100 mV	1.2 V	L
4.0 V	3.9 V	100 mV	3.95 V	H
3.9 V	4.0 V	-100 mV	3.95 V	L
0.1 V	0.0 V	100 mV	0.05 V	H
0.0 V	0.1 V	-100 mV	0.05 V	L
1.7 V	0.7 V	1000 mV	1.2 V	H
0.7 V	1.7 V	-1000 mV	1.2 V	L
4.0 V	3.0 V	1000 mV	3.5 V	H
3.0 V	4.0 V	-1000 mV	3.5 V	L
1.0 V	0.0 V	1000 mV	0.5 V	H
0.0 V	1.0 V	-1000 mV	0.5 V	L

(1) H = high level, L = low level

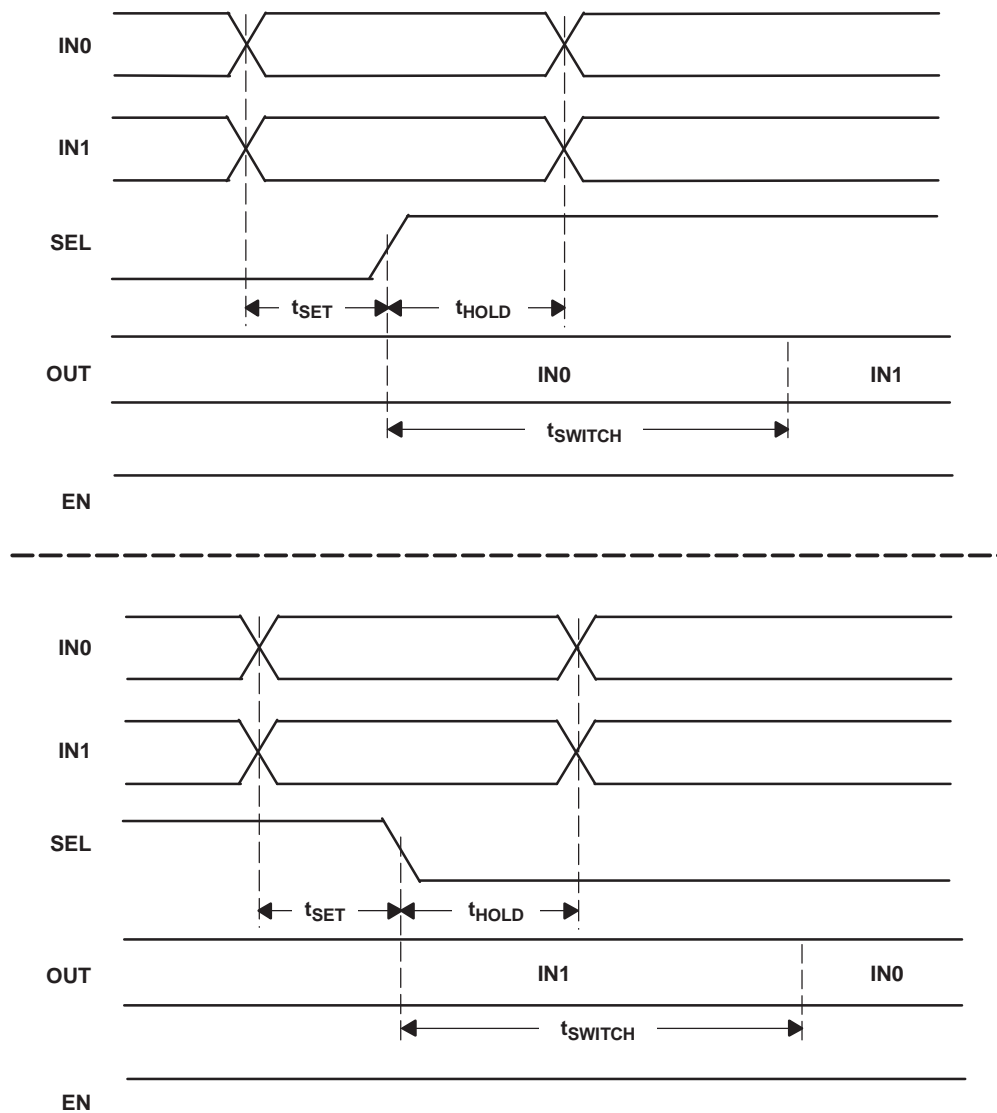

NOTE: t_{SET} and t_{HOLD} times specify that data must be in a stable state before and after mux control switches.

Figure 7. Input to Select for Both Rising and Falling Edge Setup and Hold Times

TYPICAL CHARACTERISTICS

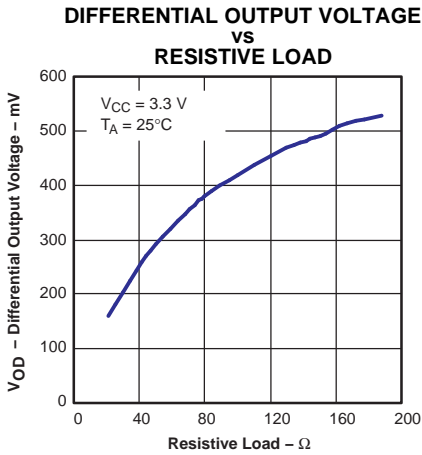

Figure 8.

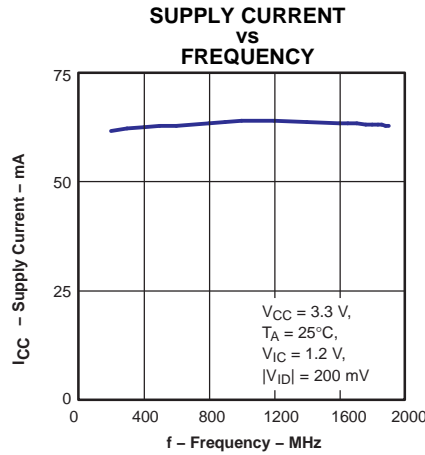

Figure 9.

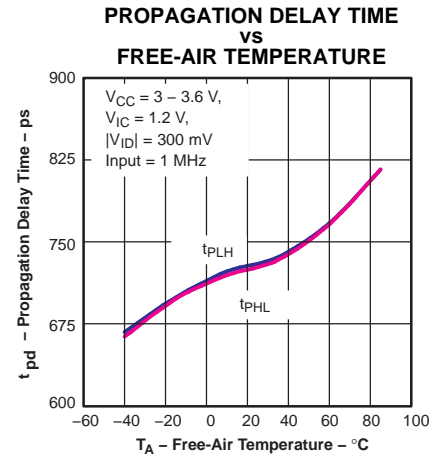

Figure 10.

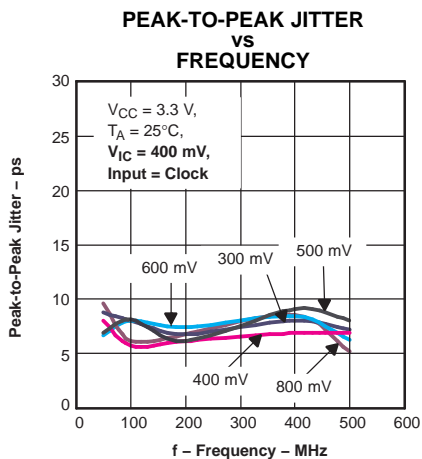

Figure 11.

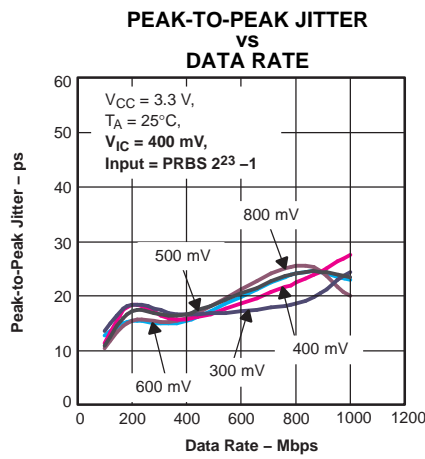

Figure 12.

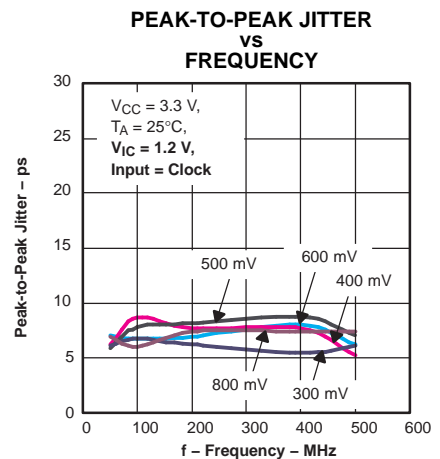

Figure 13.

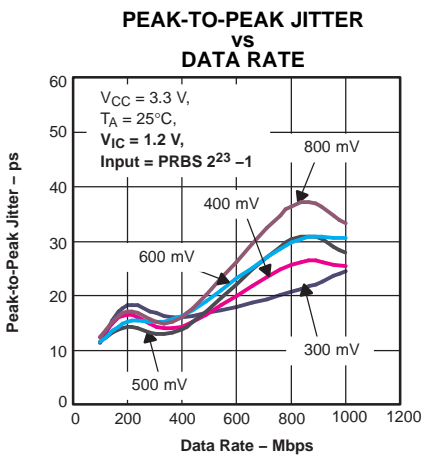

Figure 14.

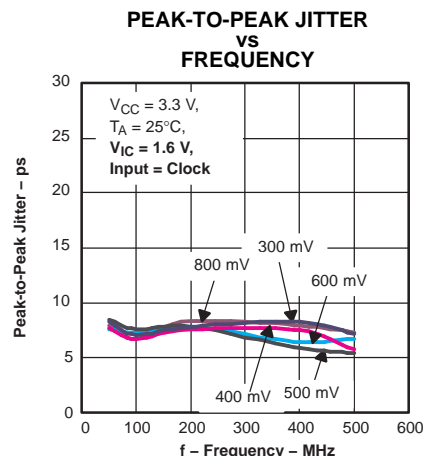

Figure 15.

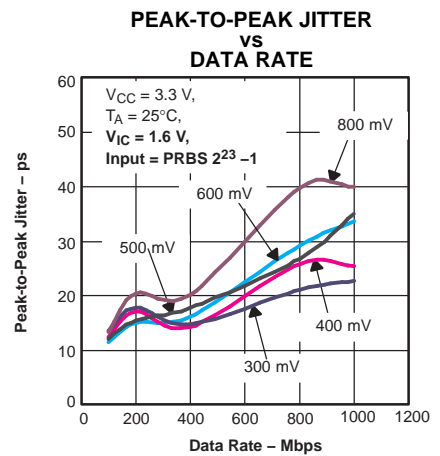

Figure 16.

TYPICAL CHARACTERISTICS (continued)

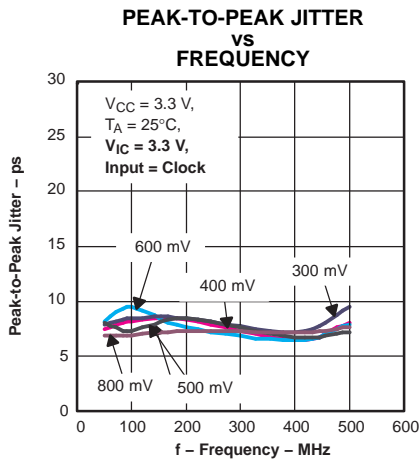

Figure 17.

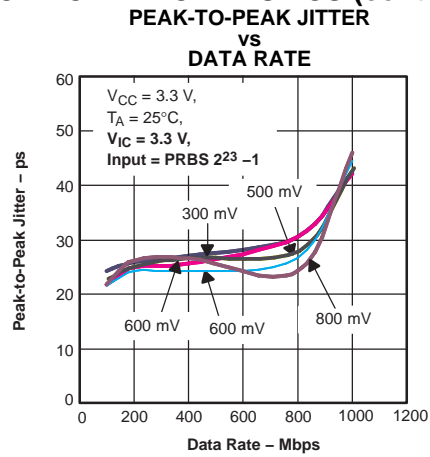

Figure 18.

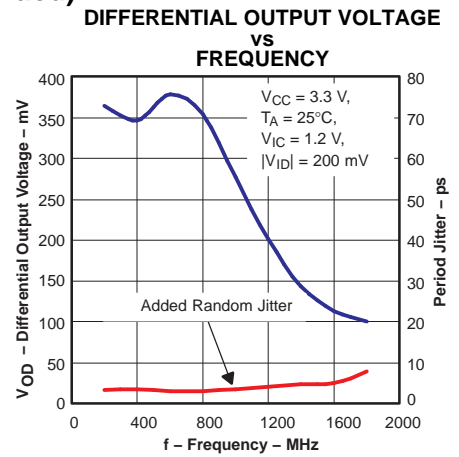

Figure 19.

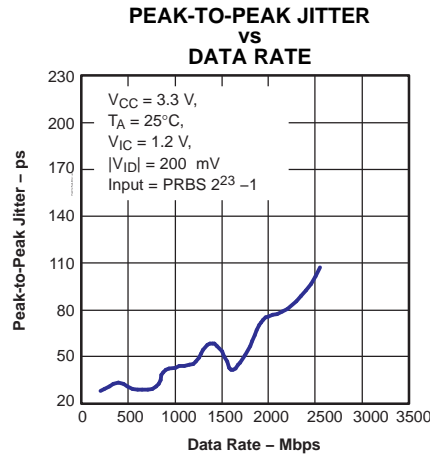

Figure 20.

APPLICATION INFORMATION

TYPICAL APPLICATION CIRCUITS (ECL, PECL, LVDS, etc.)

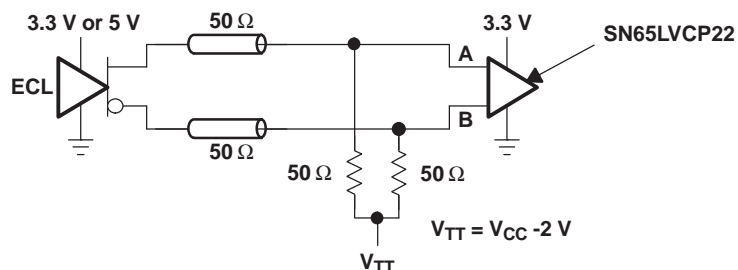

Figure 21. Low-Voltage Positive Emitter-Coupled Logic (LVPECL)

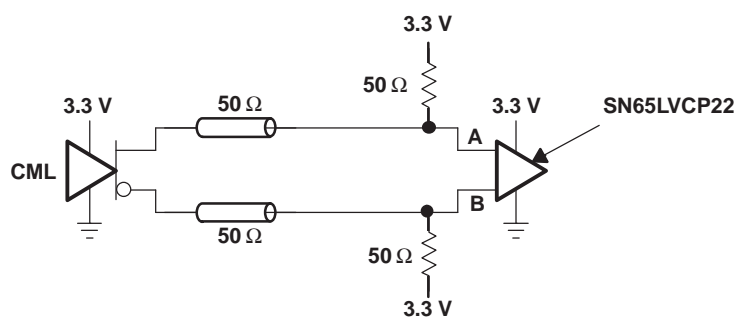

Figure 22. Current-Mode Logic (CML)

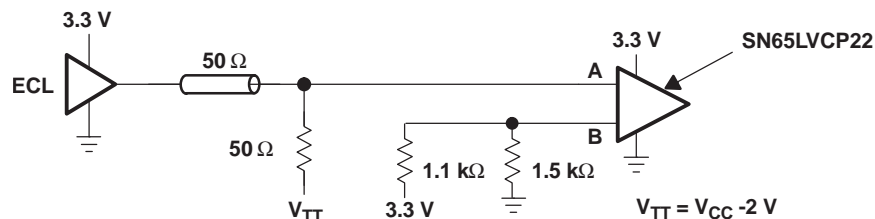

Figure 23. Single-Ended (LVPECL)

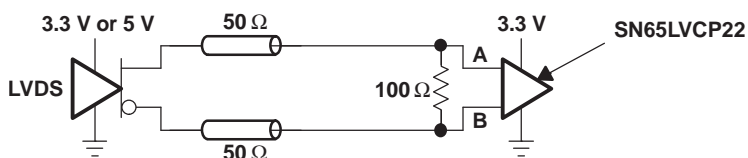

Figure 24. Low-Voltage Differential Signaling (LVDS)

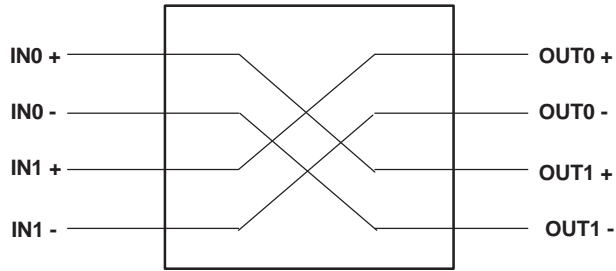

Figure 25. 2 x 2 Crosspoint

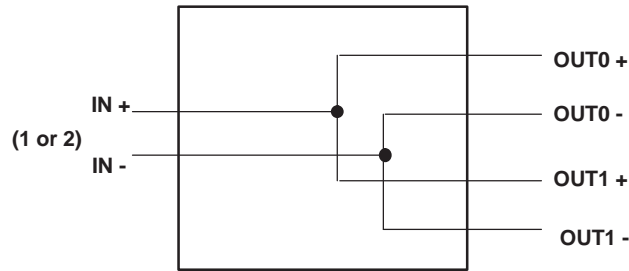

Figure 26. 1:2 Splitter



Figure 27. Dual Repeater

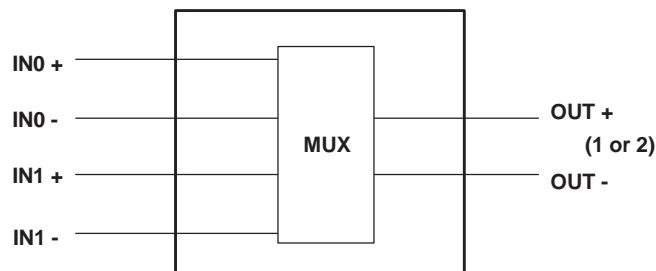



Figure 28. 2:1 MUX

REVISION HISTORY

Changes from Original (June 2012) to Revision A	Page
• Added /EM bullet to FEATURES	1
• Deleted PACKAGE/ORDERING INFORMATION table	2
• Changed SWITCHING CHARACTERISTICS, t_{JIT} and t_{Jrms}	6

PACKAGING INFORMATION

Orderable Device	Status (1)	Package Type	Package Drawing	Pins	Package Qty	Eco Plan (2)	Lead finish/ Ball material (6)	MSL Peak Temp (3)	Op Temp (°C)	Device Marking (4/5)	Samples
5962-1124201VFA	ACTIVE	CFP	W	16	1	Non-RoHS & Green	SNPB	N / A for Pkg Type	-55 to 125	5962-1124201VF A LVCP22W-SP	
SN55LVCP22W/EM	ACTIVE	CFP	W	16	1	Non-RoHS & Green	SNPB	N / A for Pkg Type	0 to 0	SN55LVCP22W/EM EVAL ONLY	

(1) The marketing status values are defined as follows:

ACTIVE: Product device recommended for new designs.

LIFEBUY: TI has announced that the device will be discontinued, and a lifetime-buy period is in effect.

NRND: Not recommended for new designs. Device is in production to support existing customers, but TI does not recommend using this part in a new design.

PREVIEW: Device has been announced but is not in production. Samples may or may not be available.

OBSELETE: TI has discontinued the production of the device.

(2) **RoHS:** TI defines "RoHS" to mean semiconductor products that are compliant with the current EU RoHS requirements for all 10 RoHS substances, including the requirement that RoHS substance do not exceed 0.1% by weight in homogeneous materials. Where designed to be soldered at high temperatures, "RoHS" products are suitable for use in specified lead-free processes. TI may reference these types of products as "Pb-Free".

RoHS Exempt: TI defines "RoHS Exempt" to mean products that contain lead but are compliant with EU RoHS pursuant to a specific EU RoHS exemption.

Green: TI defines "Green" to mean the content of Chlorine (Cl) and Bromine (Br) based flame retardants meet JS709B low halogen requirements of <=1000ppm threshold. Antimony trioxide based flame retardants must also meet the <=1000ppm threshold requirement.

(3) MSL, Peak Temp. - The Moisture Sensitivity Level rating according to the JEDEC industry standard classifications, and peak solder temperature.

(4) There may be additional marking, which relates to the logo, the lot trace code information, or the environmental category on the device.

(5) Multiple Device Markings will be inside parentheses. Only one Device Marking contained in parentheses and separated by a "~" will appear on a device. If a line is indented then it is a continuation of the previous line and the two combined represent the entire Device Marking for that device.

(6) Lead finish/Ball material - Orderable Devices may have multiple material finish options. Finish options are separated by a vertical ruled line. Lead finish/Ball material values may wrap to two lines if the finish value exceeds the maximum column width.

Important Information and Disclaimer:The information provided on this page represents TI's knowledge and belief as of the date that it is provided. TI bases its knowledge and belief on information provided by third parties, and makes no representation or warranty as to the accuracy of such information. Efforts are underway to better integrate information from third parties. TI has taken and continues to take reasonable steps to provide representative and accurate information but may not have conducted destructive testing or chemical analysis on incoming materials and chemicals. TI and TI suppliers consider certain information to be proprietary, and thus CAS numbers and other limited information may not be available for release.

In no event shall TI's liability arising out of such information exceed the total purchase price of the TI part(s) at issue in this document sold by TI to Customer on an annual basis.

OTHER QUALIFIED VERSIONS OF SN55LVCP22-SP :

- Catalog : [SN55LVCP22](#)

NOTE: Qualified Version Definitions:

- Catalog - TI's standard catalog product

TUBE

*All dimensions are nominal

Device	Package Name	Package Type	Pins	SPQ	L (mm)	W (mm)	T (μm)	B (mm)
5962-1124201VFA	W	CFP	16	1	506.98	26.16	6220	NA

W (R-GDFP-F16)

CERAMIC DUAL FLATPACK



- NOTES:
- A. All linear dimensions are in inches (millimeters).
 - B. This drawing is subject to change without notice.
 - C. This package can be hermetically sealed with a ceramic lid using glass frit.
 - D. Index point is provided on cap for terminal identification only.
 - E. Falls within MIL STD 1835 GDFP2-F16

IMPORTANT NOTICE AND DISCLAIMER

TI PROVIDES TECHNICAL AND RELIABILITY DATA (INCLUDING DATA SHEETS), DESIGN RESOURCES (INCLUDING REFERENCE DESIGNS), APPLICATION OR OTHER DESIGN ADVICE, WEB TOOLS, SAFETY INFORMATION, AND OTHER RESOURCES "AS IS" AND WITH ALL FAULTS, AND DISCLAIMS ALL WARRANTIES, EXPRESS AND IMPLIED, INCLUDING WITHOUT LIMITATION ANY IMPLIED WARRANTIES OF MERCHANTABILITY, FITNESS FOR A PARTICULAR PURPOSE OR NON-INFRINGEMENT OF THIRD PARTY INTELLECTUAL PROPERTY RIGHTS.

These resources are intended for skilled developers designing with TI products. You are solely responsible for (1) selecting the appropriate TI products for your application, (2) designing, validating and testing your application, and (3) ensuring your application meets applicable standards, and any other safety, security, regulatory or other requirements.

These resources are subject to change without notice. TI grants you permission to use these resources only for development of an application that uses the TI products described in the resource. Other reproduction and display of these resources is prohibited. No license is granted to any other TI intellectual property right or to any third party intellectual property right. TI disclaims responsibility for, and you will fully indemnify TI and its representatives against, any claims, damages, costs, losses, and liabilities arising out of your use of these resources.

TI's products are provided subject to [TI's Terms of Sale](#) or other applicable terms available either on [ti.com](https://www.ti.com) or provided in conjunction with such TI products. TI's provision of these resources does not expand or otherwise alter TI's applicable warranties or warranty disclaimers for TI products.

TI objects to and rejects any additional or different terms you may have proposed.

Mailing Address: Texas Instruments, Post Office Box 655303, Dallas, Texas 75265
Copyright © 2023, Texas Instruments Incorporated