

HCPL-M600, HCPL-M601, HCPL-M611

Small Outline, 5 Lead, High CMR,
High Speed, Logic Gate Optocouplers



Data Sheet



Description

These small outline high CMR, high speed, logic gate optocouplers are single channel devices in a five lead miniature footprint. They are electrically equivalent to the following Avago optocouplers (except there is no output enable feature):

SO-5 Package	Standard DIP	SO-8 Package
HCPL-M600	6N137	HCPL-0600
HCPL-M601	HCPL-2601	HCPL-0601
HCPL-M611	HCPL-2611	HCPL-0611

The SO-5 JEDEC registered (MO-155) package outline does not require "through holes" in a PCB. This package occupies approximately one fourth the footprint area of the standard dual-in-line package. The lead profile is designed to be compatible with standard surface mount processes.

The HCPL-M600/01/11 optically coupled gates combine a GaAsP light emitting diode and an integrated high gain photon detector. The output of the detector I.C. is an Open-collector Schottky-clamped transistor. The internal shield provides a guaranteed common mode transient immunity specification of 5,000 V/ μ s for the HCPL-M601, and 10,000 V/ μ s for the HCPL-M611.

This unique design provides maximum ac and dc circuit isolation while achieving TTL compatibility. The optocoupler ac and dc operational parameters are guaranteed from -40°C to 85°C allowing trouble free system performance.

Features

- Surface Mountable
- Very Small, Low Profile JEDEC Registered Package Outline
- Compatible with Infrared Vapor Phase Reflow and Wave Soldering Processes
- Internal Shield for High Common Mode Rejection (CMR)
HCPL-M601: 10,000 V/ μ s at $V_{\text{CM}} = 50\text{ V}$
HCPL-M611: 15,000 V/ μ s at $V_{\text{CM}} = 1000\text{ V}$
- High Speed: 10 Mbd
- LSTTL/TTL Compatible
- Low Input Current Capability: 5 mA
- Guaranteed ac and dc Performance over Temperature: -40°C to 85°C
- Safety and regulatory approvals:
 - UL recognized: 3750 Vac for 1 min. per U.L. (File No. 55361)
 - CSA component acceptance Notice #5
 - IEC/EN/DIN EN 60747-5-2 approved for HCPL-M601/M611 Option 060.
- Lead Free Option

Applications

- Isolated Line Receiver
- Simplex/Multiplex Data Transmission
- Computer-Peripheral Interface
- Microprocessor System Interface
- Digital Isolation for A/D, D/A Conversion
- Switching Power Supply
- Instrument Input/Output Isolation
- Ground Loop Elimination
- Pulse Transformer Replacement

CAUTION: The small device geometries inherent to the design of this bipolar component increase the component's susceptibility to damage from electrostatic discharge (ESD). It is advised that normal static precautions be taken in handling and assembly of this component to prevent damage and/or degradation which may be induced by ESD.

The SO-5 JEDEC registered (MO-155) package outline does not require “through holes” in a PCB. This package occupies approximately one fourth the footprint area of the standard dual-in-line package. The lead profile is designed to be compatible with standard surface mount processes.

The HCPL-M600/01/11 optically coupled gates combine a GaAsP light emitting diode and an integrated high gain photon detector. The output of the detector I.C. is an Open-collector Schottky-clamped transistor. The internal shield provides a guaranteed common mode transient immunity specification of 5,000 V/μs for the HCPL-M601, and 10,000 V/μs for the HCPL-M611.

This unique design provides maximum ac and dc circuit isolation while achieving TTL compatibility. The optocoupler ac and dc operational parameters are guaranteed from -40°C to 85°C allowing trouble free system performance.

The HCPL-M600/01/11 are suitable for high speed logic interfacing, input/output buffering, as line receivers in environments that conventional line receivers cannot tolerate, and are recommended for use in extremely high ground or induced noise environments.

Ordering Information

HCPL-xxxx is UL Recognized with 3750 Vrms for 1 minute per UL1577.

Part number	Option		Package	Surface Mount	Gull Wing	Tape & Reel	UL 5000 Vrms/ 1 Minute rating	IEC/EN/DIN EN 60747-5-2	Quantity
	RoHS Compliant	Non RoHS Compliant							
HCPL-M600	-000E	No option	SO-5	X					100 per tube
	-500E	#500		X		X			1500 per reel
HCPL-M601	-000E	No option	SO-5	X					100 per tube
HCPL-M611	-500E	#500		X		X			1500 per reel
	-560E	-		X		X		X	1500 per reel

To order, choose a part number from the part number column and combine with the desired option from the option column to form an order entry. Combination of Option 020 and Option 060 is not available.

Example 1:

HCPL-M600-500E to order product of Surface Mount SO-5 package in Tape and Reel packaging with RoHS compliant.

Example 2:

HCPL-M601 to order product of Surface Mount SO-5 package in tube packaging and non RoHS compliant.

Option datasheets are available. Contact your Avago sales representative or authorized distributor for information.

Remarks:

The notation ‘#XXX’ is used for existing products, while (new) products launched since 15th July 2001 and RoHS compliant option will use ‘-XXXE’.

Outline Drawing (JEDEC MO-155)

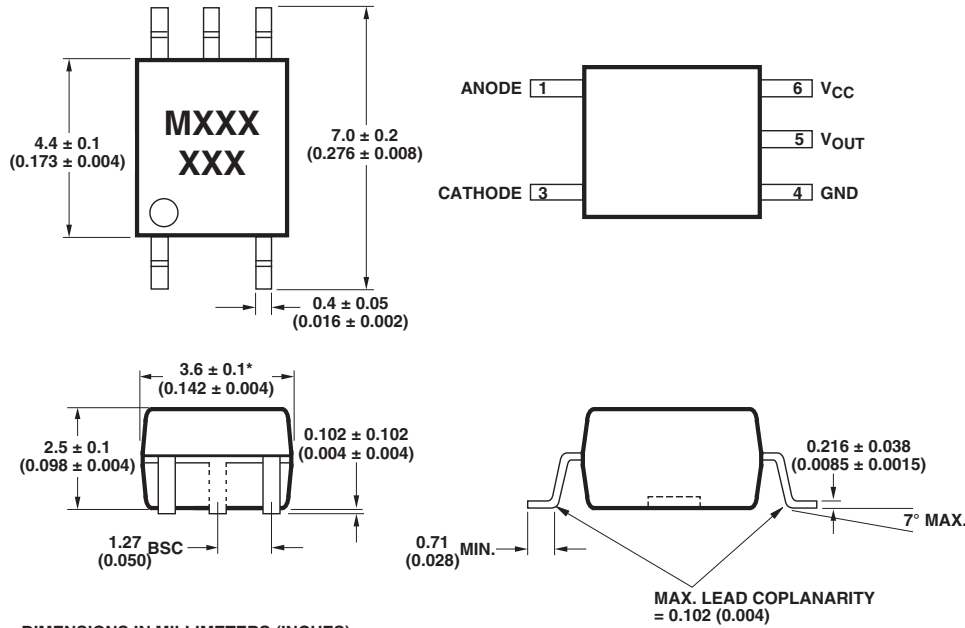

DIMENSIONS IN MILLIMETERS (INCHES)

* MAXIMUM MOLD FLASH ON EACH SIDE IS 0.15 mm (0.006)

NOTE: FLOATING LEAD PROTRUSION IS 0.15 mm (6 mils) MAX.

Land Pattern Recommendation

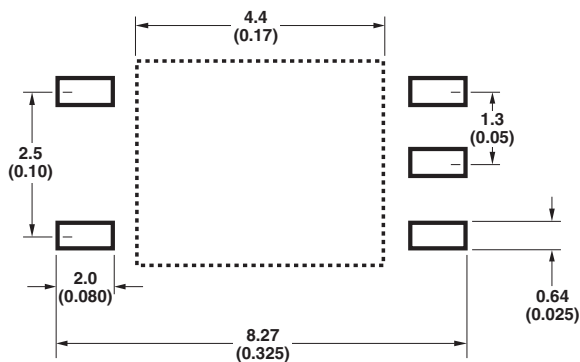

Schematic

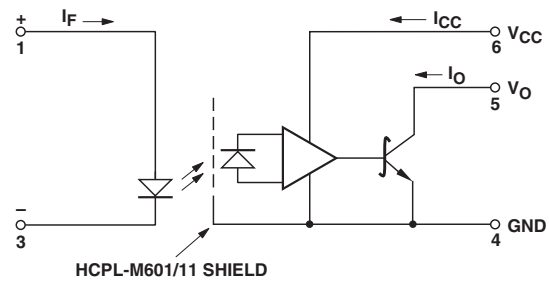

USE OF A 0.1 μF BYPASS CAPACITOR MUST BE CONNECTED BETWEEN PINS 6 AND 4 (SEE NOTE 1).

TRUTH TABLE (POSITIVE LOGIC)

LED	OUTPUT
ON	L
OFF	H

Regulatory Information

The HCPL-M600, HCPL-M601 and HCPL-M611 are approved by the following organizations:

IEC/EN/DIN EN 60747-5-5 (Option 060 only)

for HCPL-M601 and HCPL-M611

UL

Approval under UL 1577, component recognition program up to V_{ISO} = 3750 V_{RMS}.

CSA

Approval under CSA Component Acceptance Notice #5, File CA 88324.

Insulation and Safety Related Specifications

Parameter	Symbol	Value	Units	Conditions
Minimum External Air Gap (External Clearance)	L(101)	5	mm	Measured from input terminals to output terminals, shortest distance through air.
Minimum External Tracking (External Creepage)	L(102)	5	mm	Measured from input terminals to output terminals, shortest distance path along body.
Minimum Internal Plastic Gap (Internal Clearance)		0.08	mm	Through insulation distance conductor to conductor, usually the straight line distance thickness between the emitter and detector.
Tracking Resistance (Comparative Tracking Index)	CTI	175	V	DIN IEC 112/VDE 0303 Part 1
Isolation Group		IIIa		Material Group (DIN VDE 0110, 1/89, Table 1)

IEC/EN/DIN EN 60747-5-5 Insulation Characteristics* (Option 060)

Description	Symbol	Characteristic	Unit
Installation classification per DIN VDE 0110/39, Table 1 for rated mains voltage ≤ 150 Vrms for rated mains voltage ≤ 300 Vrms		I – IV I – III	
Climatic Classification		55/85/21	
Pollution Degree (DIN VDE 0110/1.89)		2	
Maximum Working Insulation Voltage	V_{IORM}	560	Vpeak
Input to Output Test Voltage, Method b* $V_{IORM} \times 1.875 = V_{PR}$, 100% Production Test with $t_m = 1$ sec, Partial discharge < 5 pC	V_{PR}	1050	Vpeak
Input to Output Test Voltage, Method a* $V_{IORM} \times 1.5 = V_{PR}$, Type and Sample Test, $t_m = 60$ sec, Partial discharge < 5 pC	V_{PR}	840	Vpeak
Highest Allowable Overvoltage (Transient Overvoltage $t_{ini} = 10$ sec)	V_{IOTM}	6000	Vpeak
Safety-limiting values – maximum values allowed in the event of a failure.			
Case Temperature	T_S	150	°C
Input Current**	$I_{S, INPUT}$	150	mA
Output Power**	$P_{S, OUTPUT}$	600	mW
Insulation Resistance at T_S , $V_{IO} = 500$ V	R_S	$> 10^9$	Ω

* Refer to the optocoupler section of the Isolation and Control Components Designer's Catalog, under Product Safety Regulations section, (IEC/EN/DIN EN 60747-5-2) for a detailed description of Method a and Method b partial discharge test profiles.

** Refer to the following figure for dependence of P_S and I_S on ambient temperature.

Recommended Operating Conditions

Parameter	Symbol	Min.	Max.	Units
Input Current, Low Level	I_{FL}^*	0	250	μA
Input Current, High Level	I_{FH}^{**}	5	15	mA
Supply Voltage, Output	V_{CC}	4.5	5.5	V
Fan Out ($R_L = 1$ k Ω)	N		5	TTL Loads
Output Pull-Up Resistor	R_L	330	4,000	Ω
Operating Temperature	T_A	-40	85	°C

* The off condition can also be guaranteed by ensuring that $V_F(\text{off}) \leq 0.8$ volts.

** The initial switching threshold is 5mA or less. It is recommended that 6.3mA to 10mA be used for best performance and to permit at least a 20% LED degradation guardband.

Absolute Maximum Ratings

(No Derating Required up to 85°C)

Parameter	Abs. Max.
Storage Temperature	-55°C to +125°C
Operating Temperature	-40°C to +85°C
Forward Input Current - I_F (see Note 2)	20 mA
Reverse Input Voltage - V_R	5 V
Supply Voltage - V_{CC} (1 Minute Maximum)	7 V
Output Collector Current - I_O	50 mA
Output Collector Power Dissipation	85 mW
Output Collector Voltage - V_O (Selection for higher output voltages up to 20 V is available)	7 V
Infrared and Vapor Phase Reflow Temperature	see below

Solder Reflow Thermal Profile

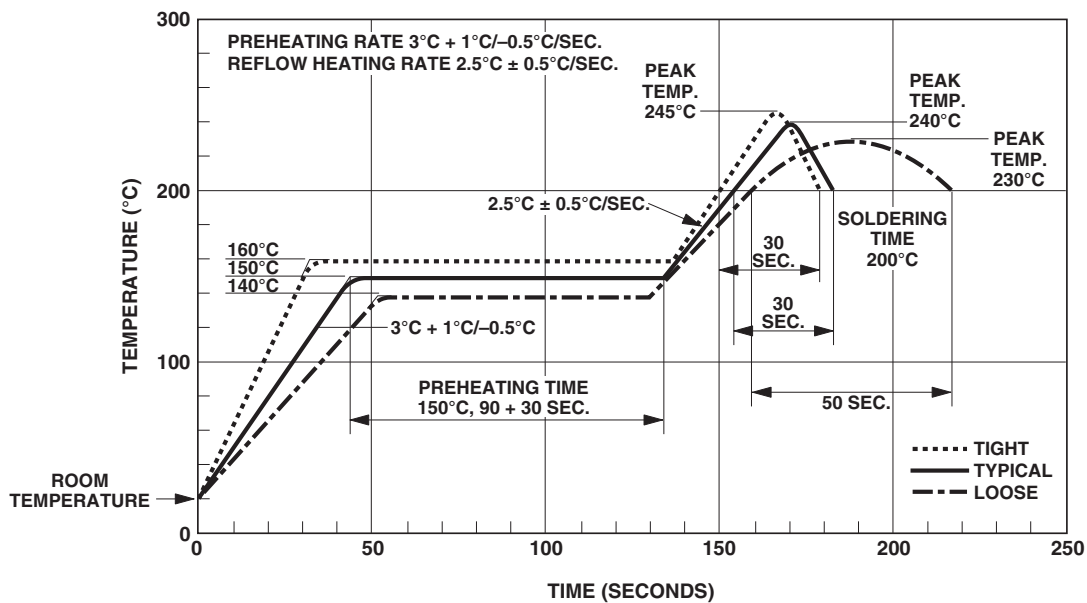

Note: Non-halide flux should be used.

Recommended Pb-Free IR Profile

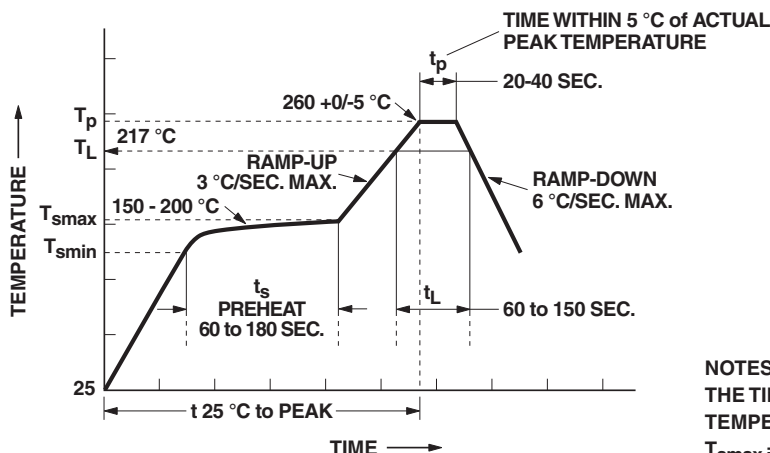

NOTES:
 THE TIME FROM 25 °C TO PEAK TEMPERATURE = 8 MINUTES MAX.
 $T_{smax} = 200^\circ\text{C}$, $T_{smin} = 150^\circ\text{C}$

Note: Non-halide flux should be used.

Insulation Related Specifications

Parameter	Symbol	Value	Units	Conditions
Min. External Air Gap (Clearance)	L(IO1)	≥5	mm	Measured from input terminals to output terminals
Min. External Tracking Path (Creepage)	L(IO2)	≥5	mm	Measured from input terminals to output terminals
Min. Internal Plastic Gap (Clearance)		0.08	mm	Through insulation distance conductor to conductor
Tracking Resistance	CTI	175	V	DIN IEC 112/VDE 0303 Part 1
Isolation Group (per DIN VDE 0109)		IIIa		Material Group DIN VDE 0109

Electrical Specifications

Over recommended temperature ($T_A = -40^{\circ}\text{C}$ to 85°C) unless otherwise specified. (See note 1.)

Parameter	Symbol	Min.	Typ.*	Max.	Units	Test Conditions	Fig.	Note
Input Threshold Current	I_{TH}		2	5	mA	$V_{CC} = 5.5\text{ V}$, $I_O \geq 13\text{ mA}$, $V_O = 0.6\text{ V}$	13	
High Level Output Current	I_{OH}		5.5	100	μA	$V_{CC} = 5.5\text{ V}$, $V_O = 5.5\text{ V}$ $I_F = 250\ \mu\text{A}$	1	
Low Level Output Voltage	V_{OL}		0.4	0.6	V	$V_{CC} = 5.5\text{ V}$, $I_F = 5\text{ mA}$, $I_{OL}(\text{Sinking}) = 13\text{ mA}$	2, 4, 5, 13	
High Level Supply Current	I_{CCH}		4	7.5	mA	$V_{CC} = 5.5\text{ V}$, $I_F = 0\text{ mA}$,		
Low Level Supply Current	I_{CCL}		6	10.5	mA	$V_{CC} = 5.5\text{ V}$, $I_F = 10\text{ mA}$,		
Input Forward Voltage	V_F	1.4	1.5	1.75	V	$T_A = 25^{\circ}\text{C}$, $I_F = 10\text{ mA}$ $I_F = 10\text{ mA}$	3	
Input Reverse Breakdown Voltage	BV_R	5				$I_R = 10\ \mu\text{A}$		
Input Capacitance	C_{IN}		60		pF	$V_F = 0\text{ V}$, $f = 1\text{ MHz}$		
Input Diode Temperature Coefficient	$\Delta V_F / \Delta T_A$		-1.6		mV/ $^{\circ}\text{C}$	$I_F = 10\text{ mA}$	12	
Input-Output Insulation	V_{ISO}	3750			V_{RMS}	$RH \leq 50\%$, $t = 1\text{ min.}$		3, 4
Resistance (Input-Output)	R_{I-O}		10^{12}		Ω	$V_{I-O} = 500\text{ V}$		3
Capacitance (Input-Output)	C_{I-O}		0.6		pF	$f = 1\text{ MHz}$		3

*All typicals at $T_A = 25^{\circ}\text{C}$, $V_{CC} = 5\text{ V}$.

Switching Specifications

Over recommended temperature ($T_A = -40^\circ\text{C}$ to 85°C), $V_{CC} = 5\text{ V}$, $I_F = 7.5\text{ mA}$ unless otherwise specified.

Parameter	Symbol	Device HCPL-	Min.	Typ.*	Max.	Unit	Test Conditions	Fig.	Note
Propagation Delay Time to High Output Level	t_{PLH}		20	48	75 100	ns	$T_A = 25^\circ\text{C}$ $R_L = 350\ \Omega$ $C_L = 15\ \text{pF}$	6, 7 8	5
Propagation Delay Time to Low Output Level	t_{PHL}		25	50	75 100		$T_A = 25^\circ\text{C}$	6, 7 8	6
Propagation Delay Skew	t_{PSK}				40				10, 11
Pulse Width Distortion	$ t_{PHL} - t_{PLH} $			3.5	35			9	10
Output Rise Time (10%-90%)	t_{rise}			24				10	
Output Fall Time (10%-90%)	t_{fall}			10				10	
Common Mode Transient Immunity at High Output Level	$ CM_H $	M600		10,000		V/ μs	$V_{CM} = 10\text{ V}$ $V_{O(min)} = 2\text{ V}$	11	7, 9
		M601	5,000	10,000	$V_{CM} = 50\text{ V}$ $I_F = 0\text{ mA}$ $T_A = 25^\circ\text{C}$				
		M611	10,000	15,000	$V_{CM} = 1000\text{ V}$				
Common Mode Transient Immunity at Low Output Level	$ CM_H $	M600		10,000		V/ μs	$V_{CM} = 10\text{ V}$ $V_{O(max)} = 0.8\text{ V}$	11	8, 9
		M601	5,000	10,000	$V_{CM} = 50\text{ V}$ $R_L = 350\ \Omega$ $I_F = 7.5\text{ mA}$ $T_A = 25^\circ\text{C}$				
		M611	10,000	15,000	$V_{CM} = 1000\text{ V}$				

*All typicals at $T_A = 25^\circ\text{C}$, $V_{CC} = 5\text{ V}$.

Notes:

- Bypassing of the power supply line is required with a 0.1 μF ceramic disc capacitor adjacent to each optocoupler. The total lead length between both ends of the capacitor and the isolator pins should not exceed 10 mm.
- Peaking circuits may produce transient input currents up to 50 mA, 50 ns maximum pulse width, provided average current does not exceed 20 mA.
- Device considered a two terminal device: pins 1 and 3 shorted together, and pins 4, 5 and 6 shorted together.
- In accordance with UL 1577, each optocoupler is proof tested by applying an insulation test voltage $\geq 4500\text{ V}_{\text{RMS}}$ for 1 second (Leakage detection current limit, $I_{I-O} \leq 5\ \mu\text{A}$).
- The t_{PLH} propagation delay is measured from 3.75 mA point on the falling edge of the input pulse to the 1.5 V point on the rising edge of the output pulse.
- The t_{PHL} propagation delay is measured from 3.75 mA point on the rising edge of the input pulse to the 1.5 V point on the falling edge of the output pulse.
- CM_H is the maximum tolerable rate of rise of the common mode voltage to assure that the output will remain in a high logic state (i.e., $V_{OUT} > 2.0\text{ V}$).
- CM_L is the maximum tolerable rate of fall of the common mode voltage to assure that the output will remain in a low logic state (i.e., $V_{OUT} > 0.8\text{ V}$).
- For sinusoidal voltages, $(|dV_{CM}|/dt)_{\text{max}} = \pi f_{CM} V_{CM(p-p)}$.
- See application section; "Propagation Delay, Pulse-Width Distortion and Propagation Delay Skew" for more information.
- t_{PSK} is equal to the worst case difference in t_{PHL} and/or t_{PLH} that will be seen between units at any given temperature within the worst case operating condition range.

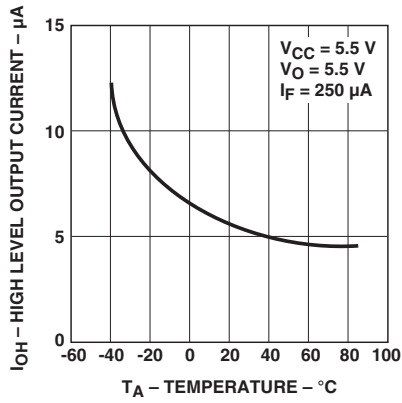

Figure 1. High Level Output Current vs. Temperature.

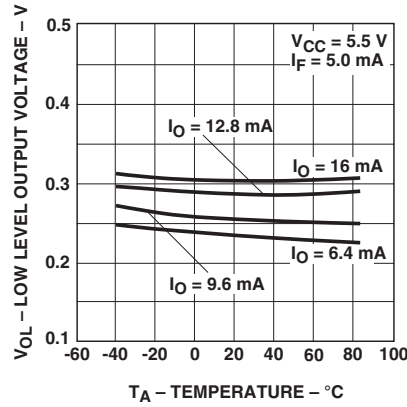

Figure 2. Low Level Output Voltage vs. Temperature.

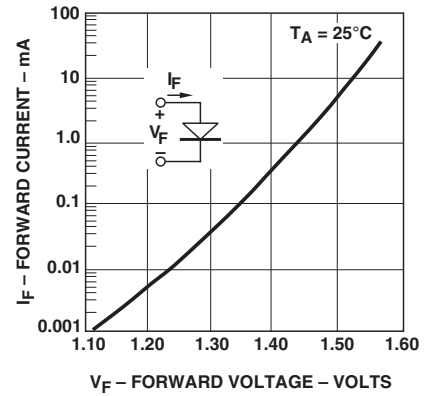

Figure 3. Input Diode Forward Characteristic.

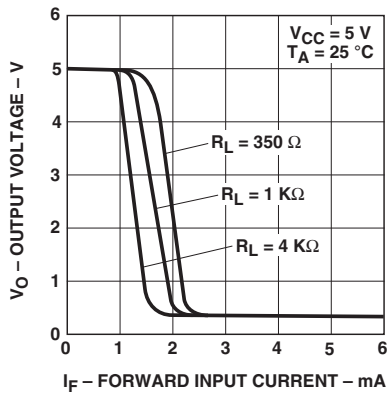

Figure 4. Output Voltage vs. Forward Input current.

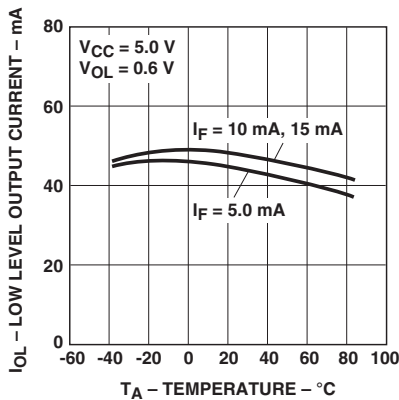
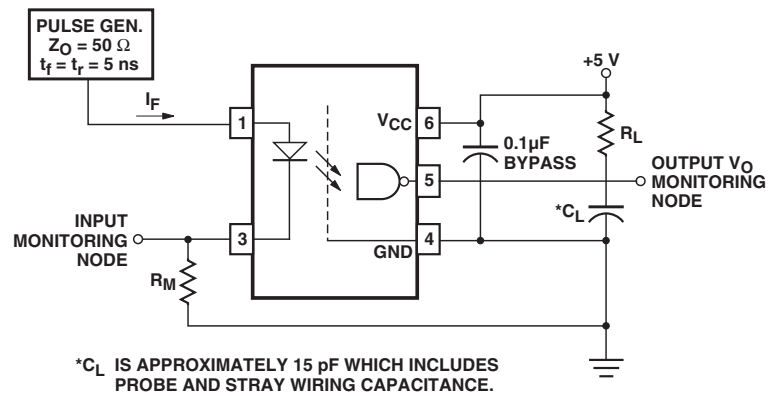

Figure 5. Low Level Output Current vs. Temperature.

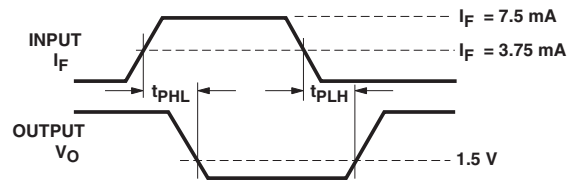

Figure 6. Test Circuit for t_{PHL} and t_{PLH} .

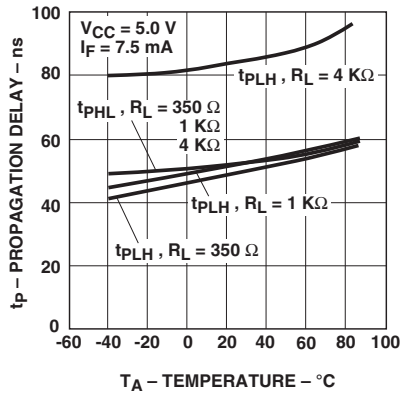

Figure 7. Propagation Delay vs. Temperature.

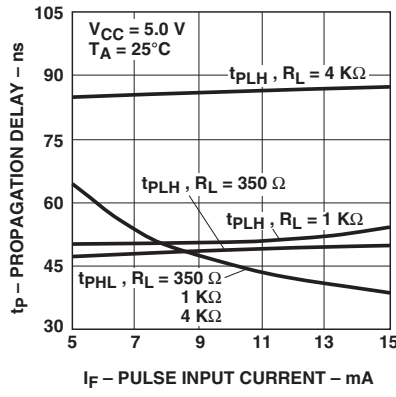

Figure 8. Propagation Delay vs. Pulse Input Current.

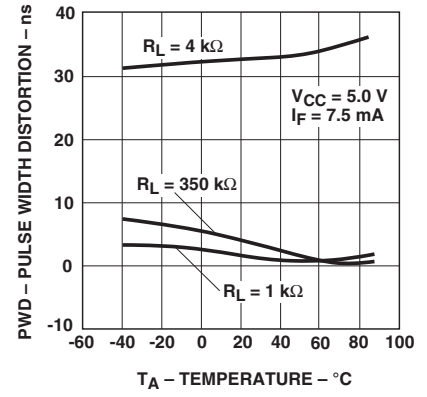

Figure 9. Pulse Width Distortion vs. Temperature.

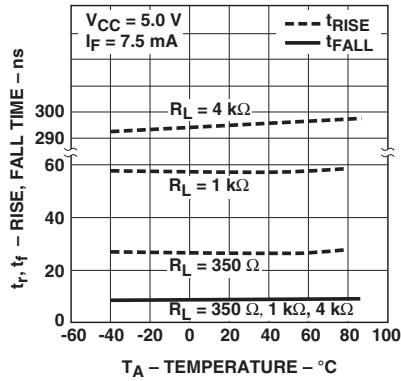

Figure 10. Rise and Fall Time vs. Temperature.

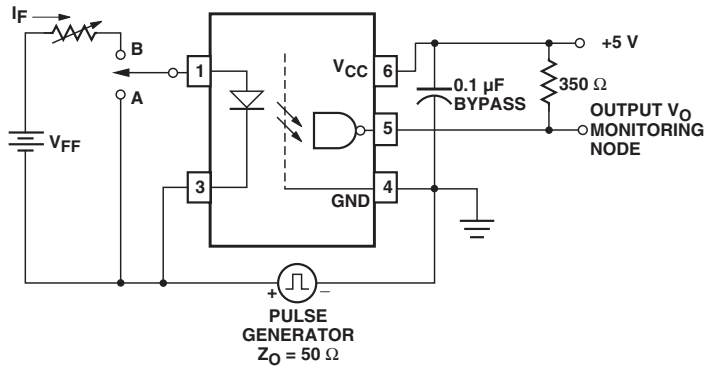

Figure 11. Test Circuit for Common Mode Transient Immunity and Typical Waveforms.

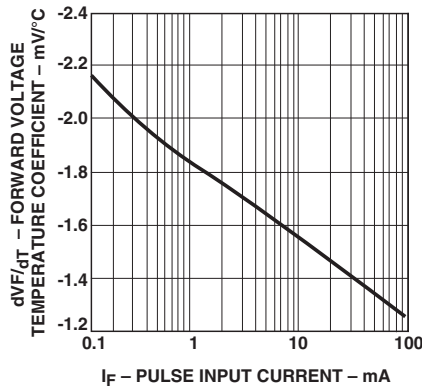

Figure 12. Temperature Coefficient for Forward Voltage vs. Input Current.

Propagation Delay, Pulse-Width Distortion and Propagation Delay Skew

Propagation delay is a figure of merit which describes how quickly a logic signal propagates through a system. The propagation delay from low to high (t_{PLH}) is the amount of time required for an input signal to propagate to the output, causing the output to change from low to high. Similarly, the propagation delay from high to low (t_{PHL}) is the amount of time required for the input signal to propagate to the output, causing the output to change from high to low (see Figure 7).

Pulse-width distortion (PWD) results when t_{PLH} and t_{PHL} differ in value. PWD is defined as the difference between t_{PLH} and t_{PHL} and often determines the maximum data rate capability of a transmission system. PWD can be expressed in percent by dividing the PWD (in ns) by the minimum pulse width (in ns) being transmitted. Typically, PWD on the order of 20-30% of the minimum pulse width is tolerable; the exact figure depends on the particular application (RS232, RS422, T-1, etc.).

Propagation delay skew, t_{PSK} , is an important parameter to consider in parallel data applications where synchronization of signals on parallel data lines is a concern. If the parallel data is being sent through a group of optocouplers, differences in propagation delays will cause the data to arrive at the outputs of the optocouplers at different times. If this difference in propagation delays is large enough, it will determine the maximum rate at which parallel data can be sent through the optocouplers.

Propagation delay skew is defined as the difference between the minimum and maximum propagation delays, either t_{PLH} or t_{PHL} , for any given group of optocouplers which are operating under the same conditions (i.e., the same drive current, supply voltage, output load, and operating temperature). As illustrated in Figure 15, if the in-

puts of a group of optocouplers are switched either ON or OFF at the same time, t_{PSK} is the difference between the shortest propagation delay, either t_{PLH} or t_{PHL} , and the longest propagation delay, either t_{PLH} or t_{PHL} .

As mentioned earlier, t_{PSK} can determine the maximum parallel data transmission rate. Figure 11 is the timing diagram of a typical parallel data application with both the clock and the data lines being sent through optocouplers. The figure shows data and clock signals at the inputs and outputs of the optocouplers. To obtain the maximum data transmission rate, both edges of the clock signal are being used to clock the data; if only one edge were used, the clock signal would need to be twice as fast.

Propagation delay skew represents the uncertainty of where an edge might be after being sent through an optocoupler. Figure 16 shows that there will be uncertainty in both the data and the clock lines. It is important that these two areas of uncertainty not overlap, otherwise the clock signal might arrive before all of the data outputs have settled, or some of the data outputs may start to change before the clock signal has arrived. From these considerations, the absolute minimum pulse width that can be sent through optocouplers in a parallel application is twice t_{PSK} . A cautious design should use a slightly longer pulse width to ensure that any additional uncertainty in the rest of the circuit does not cause a problem.

The t_{PSK} specified optocouplers offer the advantages of guaranteed specifications for propagation delays, pulse-width distortion and propagation delay skew over the recommended temperature, and input current, and power supply ranges.

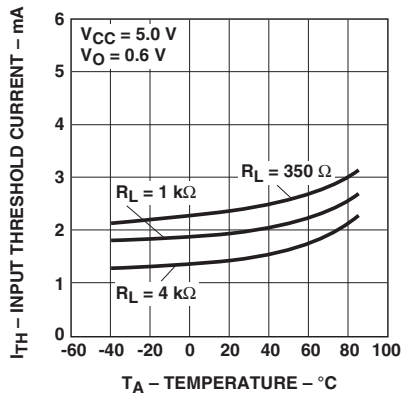

Figure 13. Input Threshold Current vs. Temperature.

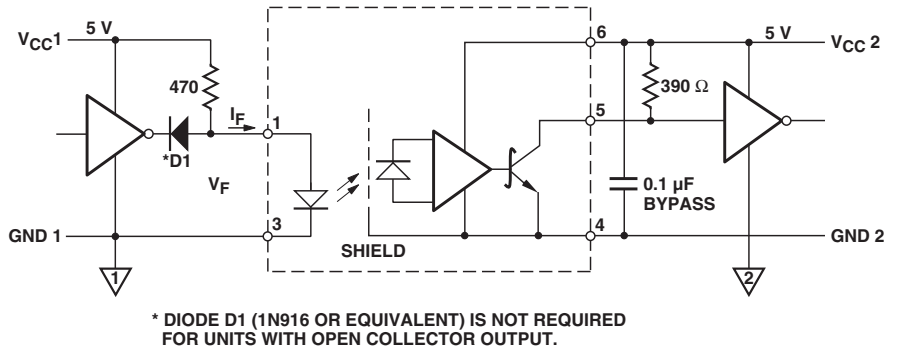

Figure 14. Recommended TTL/LSTTL to TTL/LSTTL Interface Circuit.

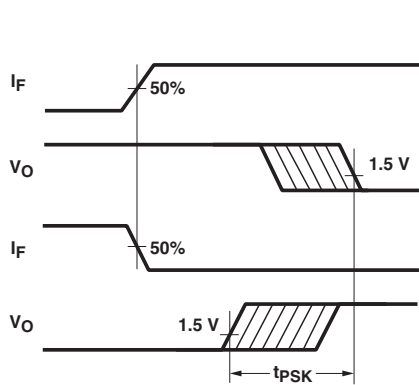

Figure 15. Illustration of Propagation Delay Skew - t_{PSK} .

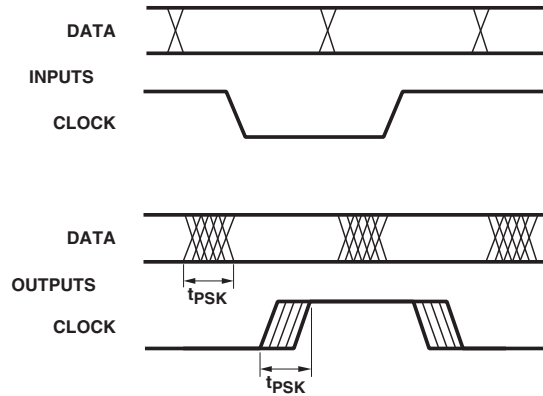

Figure 16. Parallel Data Transmission Example.

For product information and a complete list of distributors, please go to our website: www.avagotech.com

Avago, Avago Technologies, and the A logo are trademarks of Avago Technologies in the United States and other countries. Data subject to change. Copyright © 2005-2010 Avago Technologies. All rights reserved. Obsoletes AV01-0562EN AV02-0941EN - February 23, 2010



Mouser Electronics

Authorized Distributor

Click to View Pricing, Inventory, Delivery & Lifecycle Information:

Broadcom Limited:

[HCPL-M600](#) [HCPL-M600#500](#) [HCPL-M600-000E](#) [HCPL-M600-500E](#) [HCPL-M601](#) [HCPL-M601#500](#) [HCPL-M601-000E](#) [HCPL-M601-500E](#) [HCPL-M601-560E](#) [HCPL-M611](#) [HCPL-M611#500](#) [HCPL-M611-000E](#) [HCPL-M611-500E](#)