

2.7-V TO 5.5-V LOW-POWER DUAL 12-BIT DIGITAL-TO-ANALOG CONVERTER WITH INTERNAL REFERENCE AND POWER DOWN

FEATURES

- Dual 12-Bit Voltage Output DAC
- Programmable Internal Reference
- Programmable Settling Time:
 - 1 μ s in Fast Mode,
 - 3.5 μ s in Slow Mode
- Compatible With TMS320 and SPI™ Serial Ports
- Differential Nonlinearity <0.5 LSB Typ
- Monotonic Over Temperature

APPLICATIONS

- Digital Servo Control Loops
- Digital Offset and Gain Adjustment
- Industrial Process Control
- Machine and Motion Control Devices
- Mass Storage Devices

D, JG PACKAGE
(TOP VIEW)

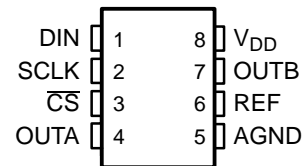

FK PACKAGE
(TOP VIEW)

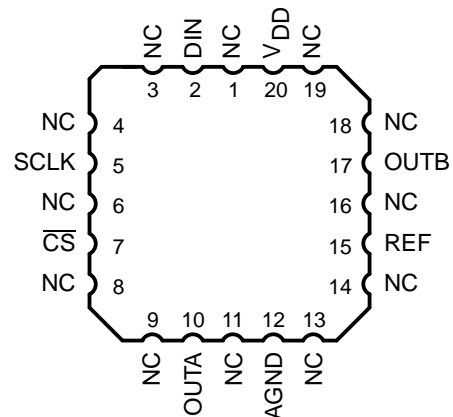

DESCRIPTION

The TLV5638 is a dual 12-bit voltage output DAC with a flexible 3-wire serial interface. The serial interface allows glueless interface to TMS320, SPI™, QSPI™, and Microwire™ serial ports. It is programmed with a 16-bit serial string containing 4 control and 12 data bits.

The resistor string output voltage is buffered by a x2 gain rail-to-rail output buffer. The buffer features a Class AB output stage to improve stability and reduce settling time. The programmable settling time of the DAC allows the designer to optimize speed vs power dissipation. With its on-chip programmable precision voltage reference, the TLV5638 simplifies overall system design.

Because of its ability to source up to 1 mA, the reference can also be used as a system reference. Implemented with a CMOS process, the device is designed for single supply operation from 2.7 V to 5.5 V. It is available in an 8-pin SOIC package to reduce board space in standard commercial, industrial, and automotive temperature ranges. It is also available in JG and FK packages in the military temperature range.



Please be aware that an important notice concerning availability, standard warranty, and use in critical applications of Texas Instruments semiconductor products and disclaimers thereto appears at the end of this data sheet.

SPI, QSPI are trademarks of Motorola, Inc.
Microwire is a trademark of National Semiconductor Corporation.



This integrated circuit can be damaged by ESD. Texas Instruments recommends that all integrated circuits be handled with appropriate precautions. Failure to observe proper handling and installation procedures can cause damage.

ESD damage can range from subtle performance degradation to complete device failure. Precision integrated circuits may be more susceptible to damage because very small parametric changes could cause the device not to meet its published specifications.

AVAILABLE OPTIONS

T _A	PACKAGE		
	SOIC (D)	CERAMIC DIP (JG)	20 PAD LCCC (FK)
0°C to 70°C	TLV5638CD	—	—
40°C to 85°C	TLV5638ID	—	—
40°C to 125°C	TLV5638QD TLV5638QDR	—	—
55°C to 125°C	—	TLV5638MJG	TLV5638MFK

FUNCTIONAL BLOCK DIAGRAM

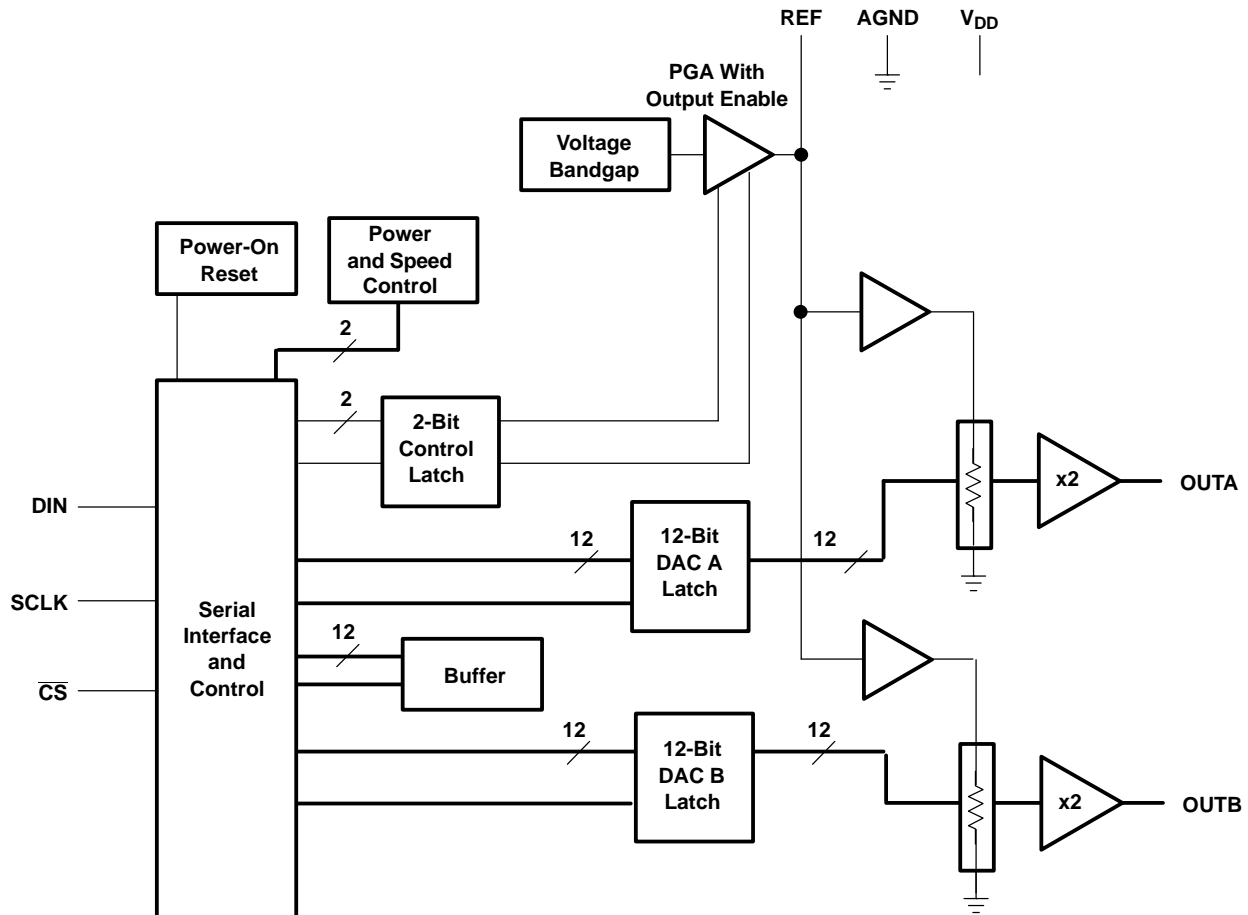

Terminal Functions

TERMINAL NAME	NO.	I/O/P	DESCRIPTION
AGND	5	P	Ground
\overline{CS}	3	I	Chip select. Digital input active low, used to enable/disable inputs
DIN	1	I	Digital serial data input
OUT A	4	O	DAC A analog voltage output
OUT B	7	O	DAC B analog voltage output
REF	6	I/O	Analog reference voltage input/output
SCLK	2	I	Digital serial clock input
V _{DD}	8	P	Positive power supply

ABSOLUTE MAXIMUM RATINGS

over operating free-air temperature range (unless otherwise noted)⁽¹⁾

	UNIT	
Supply voltage (V _{DD} to AGND)	7 V	
Reference input voltage range	-0.3 V to V _{DD} + 0.3 V	
Digital input voltage range	-0.3 V to V _{DD} + 0.3 V	
Operating free-air temperature range, T _A	TLV5638C	0°C to 70°C
	TLV5638I	-40°C to 85°C
	TLV5638Q	-40°C to 125°C
	TLV5638M	-55°C to 125°C
Storage temperature range, T _{stg}	-65°C to 150°C	
Lead temperature 1,6 mm (1/16 inch) from case for 10 seconds	260°C	

(1) Stresses beyond those listed under „ absolute maximum ratings” may cause permanent damage to the device. These are stress ratings only, and functional operation of the device at these or any other conditions beyond those indicated under „ recommended operating conditions” is not implied. Exposure to absolute-maximum-rated conditions for extended periods may affect device reliability.

DISSIPATION RATING TABLE

PACKAGE	T _A ≤ 25°C POWER RATING	DERATING FACTOR ABOVE T _A = 25°C ⁽¹⁾	T _A = 70°C POWER RATING	T _A = 85°C POWER RATING	T _A = 125°C POWER RATING
D	635 mW	5.08 mW/°C	407 mW	330 mW	127 mW
FK	1375 mW	11.00 mW/°C	880 mW	715 mW	275 mW
JG	1050 mW	8.40 mW/°C	672 mW	546 mW	210 mW

(1) This is the inverse of the traditional Junction-to-Ambient thermal Resistance (R_{θJA}). Thermal Resistances are not production tested and are for informational purposes only.

RECOMMENDED OPERATING CONDITIONS

		MIN	NOM	MAX	UNIT
Supply voltage, V_{DD}	$V_{DD} = 5\text{ V}$	4.5	5	5.5	V
	$V_{DD} = 3\text{ V}$	2.7	3	3.3	V
Power on reset, POR		0.55 ⁽¹⁾		2 ⁽¹⁾	V
High-level digital input voltage, V_{IH}	$V_{DD} = 2.7\text{ V}$	2			V
	$V_{DD} = 5.5\text{ V}$	2.4			
Low-level digital input voltage, V_{IL}	$V_{DD} = 2.7\text{ V}$			0.6	V
	$V_{DD} = 5.5\text{ V}$	TLV5638C and TLV5638I		1	V
		TLV5638Q and TLV5638M		0.8	
Reference voltage, V_{ref} to REF terminal	$V_{DD} = 5\text{ V}$ ⁽²⁾	AGND	2.048	$V_{DD}-1.5$	V
Reference voltage, V_{ref} to REF terminal	$V_{DD} = 3\text{ V}$ ⁽²⁾	AGND	1.024	$V_{DD}-1.5$	V
Load resistance, R_L		2			k Ω
Load capacitance, C_L				100	pF
Clock frequency, f_{CLK}				20	MHz
Operating free-air temperature, T_A	TLV5638C	0		70	°C
	TLV5638I	40		85	
	TLV5638Q	40		125	
	TLV5638M	55		125	

(1) This parameter is not tested for Q and M suffix devices.

(2) Due to the x2 output buffer, a reference input voltage $\geq (V_{DD}-0.4\text{ V})/2$ causes clipping of the transfer function. The output buffer of the internal reference must be disabled, if an external reference is used.

ELECTRICAL CHARACTERISTICS

over recommended operating conditions, $V_{ref} = 2.048\text{ V}$, $V_{ref} = 1.024\text{ V}$ (unless otherwise noted)

POWER SUPPLY						
PARAMETER	TEST CONDITIONS		TLV5638C, I TLV5638M			UNIT
			MIN	TYP	MAX	
I_{DD} Power supply current	No load, All inputs = AGND or V_{DD} , DAC latch = 0x800	$V_{DD} = 5\text{ V}$, Int. ref.	Fast	4.3	7	mA
			Slow	2.2	3.6	
		$V_{DD} = 3\text{ V}$, Int. ref.	Fast	3.8	6.3	mA
			Slow	1.8	3.0	
		$V_{DD} = 5\text{ V}$, Ext. ref.	Fast	3.9	6.3	mA
			Slow	1.8	3.0	
		$V_{DD} = 3\text{ V}$, Ext. ref.	Fast	3.5	5.7	mA
			Slow	1.5	2.6	
Power-down supply current			0.01	10	μA	
PSRR Power supply rejection ratio	Zero scale, ⁽¹⁾			65	dB	
	Full scale, ⁽²⁾			65		

(1) Power supply rejection ratio at zero scale is measured by varying V_{DD} and is given by: $PSRR = 20 \log [(E_{ZS}(V_{DDmax}) - E_{ZS}(V_{DDmin}))/V_{DDmax}]$

(2) Power supply rejection ratio at full scale is measured by varying V_{DD} and is given by: $PSRR = 20 \log [(E_G(V_{DDmax}) - E_G(V_{DDmin}))/V_{DDmax}]$

ELECTRICAL CHARACTERISTICS (Continued)

over recommended operating conditions, $V_{ref} = 2.048\text{ V}$, $V_{ref} = 1.024\text{ V}$ (unless otherwise noted)

STATIC DAC SPECIFICATIONS							
PARAMETER		TEST CONDITIONS		MIN	TYP	MAX	UNIT
Resolution				12			bits
INL	Integral nonlinearity, end point adjusted	See (1)	C and I suffixes	±1.7	±4		LSB
			Q and M suffixes	±1.7	±6		LSB
DNL	Differential nonlinearity	See (2)		±0.4	±1		LSB
E_{ZS}	Zero-scale error (offset error at zero scale)	See (3)				±24	mV
$E_{ZS}TC$	Zero-scale-error temperature coefficient	See (4)			10		ppm/°C
E_G	Gain error	See (5)				±0.6	% full scale V
E_GTC	Gain error temperature coefficient	See (6)			10		ppm/°C
OUTPUT SPECIFICATIONS							
V_O	Output voltage	$R_L = 10\text{ k}\Omega$		0	$V_{DD}-0.4$		V
	Output load regulation accuracy	$V_O = 4.096\text{ V}, 2.048\text{ V}, R_L = 2\text{ k}\Omega$				±0.25	% full scale V
REFERENCE PIN CONFIGURED AS OUTPUT (REF)							
$V_{ref}(OUTL)$	Low reference voltage			1.003	1.024	1.045	V
$V_{ref}(OUTH)$	High reference voltage	$V_{DD} > 4.75\text{ V}$		2.027	2.048	2.069	V
$I_{ref}(\text{source})$	Output source current					1	mA
$I_{ref}(\text{sink})$	Output sink current			-1			mA
	Load capacitance					100	pF
PSRR	Power supply rejection ratio				-65		dB
REFERENCE PIN CONFIGURED AS INPUT (REF)							
V_I	Input voltage			0	$V_{DD}-1.5$		V
R_I	Input resistance				10		M Ω
C_I	Input capacitance				5		pF
	Reference input bandwidth	REF = $0.2 V_{pp} + 1.024\text{ V dc}$	Fast		1.3		MHz
			Slow		525		kHz
	Reference feedthrough	REF = $1 V_{pp}$ at 1.024 V dc (7)			-80		dB
DIGITAL INPUTS							
I_{IH}	High-level digital input current	$V_I = V_{DD}$				1	μA
I_{IL}	Low-level digital input current	$V_I = 0\text{ V}$		-1			μA
C_i	Input capacitance				8		pF

- (1) The relative accuracy or integral nonlinearity (INL) sometimes referred to as linearity error, is the maximum deviation of the output from the line between zero and full scale excluding the effects of zero code and full-scale errors. Tested from code 32 to 4095.
- (2) The differential nonlinearity (DNL) sometimes referred to as differential error, is the difference between the measured and ideal 1 LSB amplitude change of any two adjacent codes. Monotonic means the output voltage changes in the same direction (or remains constant) as a change in the digital input code.
- (3) Zero-scale error is the deviation from zero voltage output when the digital input code is zero.
- (4) Zero-scale-error temperature coefficient is given by: $E_{ZS} TC = [E_{ZS}(T_{max}) - E_{ZS}(T_{min})]/V_{ref} \times 10^6 / (T_{max} - T_{min})$.
- (5) Gain error is the deviation from the ideal output ($2V_{ref} - 1\text{ LSB}$) with an output load of $10\text{ k}\Omega$ excluding the effects of the zero-error.
- (6) Gain temperature coefficient is given by: $E_G TC = [E_G(T_{max}) - E_G(T_{min})]/V_{ref} \times 10^6 / (T_{max} - T_{min})$.
- (7) Reference feedthrough is measured at the DAC output with an input code = $0x000$.

ELECTRICAL CHARACTERISTICS (Continued)

over recommended operating conditions, $V_{ref} = 2.048\text{ V}$, $V_{ref} = 1.024\text{ V}$ (unless otherwise noted)

ANALOG OUTPUT DYNAMIC PERFORMANCE						
PARAMETER		TEST CONDITIONS	MIN	TYP	MAX	UNIT
$t_{s(FS)}$	Output settling time, full scale	$R_L = 10\text{ k}\Omega$, $C_L = 100\text{ pF}$, See (1)	Fast	1	3	μs
			Slow	3.5	7	
$t_{s(CC)}$	Output settling time, code to code	$R_L = 10\text{ k}\Omega$, $C_L = 100\text{ pF}$, See (2)	Fast	0.5	1.5	μs
			Slow	1	2	
SR	Slew rate	$R_L = 10\text{ k}\Omega$, $C_L = 100\text{ pF}$, See (3)	Fast	12		$\text{V}/\mu\text{s}$
			Slow	1.8		
Glitch energy		$\text{DIN} = 0\text{ to }1$, $\text{FCLK} = 100\text{ kHz}$, $\overline{\text{CS}} = V_{DD}$	5		$\text{nV}\cdot\text{s}$	
SNR	Signal-to-noise ratio	$f_s = 480\text{ kSPS}$, $f_{out} = 1\text{ kHz}$, $R_L = 10\text{ k}\Omega$, $C_L = 100\text{ pF}$	69	74	dB	
S/(N+D)	Signal-to-noise + distortion		58	67		
THD	Total harmonic distortion		69	57		
Spurious free dynamic range			57	72		

- (1) Settling time is the time for the output signal to remain within $\pm 0.5\text{ LSB}$ of the final measured value for a digital input code change of $0x020$ to $0xFDF$ and $0xFDF$ to $0x020$ respectively. Not tested, assured by design.
- (2) Settling time is the time for the output signal to remain within $\pm 0.5\text{ LSB}$ of the final measured value for a digital input code change of one count. Not tested, assured by design.
- (3) Slew rate determines the time it takes for a change of the DAC output from 10% to 90% full-scale voltage.

DIGITAL INPUT TIMING REQUIREMENTS

	MIN	NOM	MAX	UNIT
$t_{su(CS-CK)}$ Setup time, $\overline{\text{CS}}$ low before first negative SCLK edge	10			ns
$t_{su(C16-CS)}$ Setup time, 16 th negative SCLK edge (when D0 is sampled) before $\overline{\text{CS}}$ rising edge	10			ns
t_{wH} SCLK pulse width high	25			ns
t_{wL} SCLK pulse width low	25			ns
$t_{su(D)}$ Setup time, data ready before SCLK falling edge	10			ns
$t_{h(D)}$ Hold time, data held valid after SCLK falling edge	5			ns

PARAMETER MEASUREMENT INFORMATION

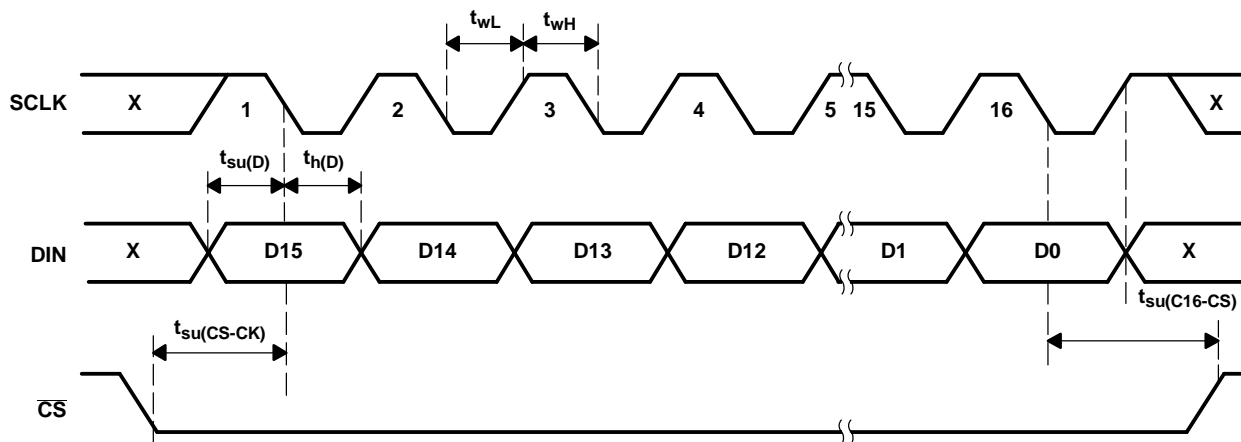

Figure 1. Timing Diagram

TYPICAL CHARACTERISTICS

POWER DOWN SUPPLY CURRENT
VS
TIME

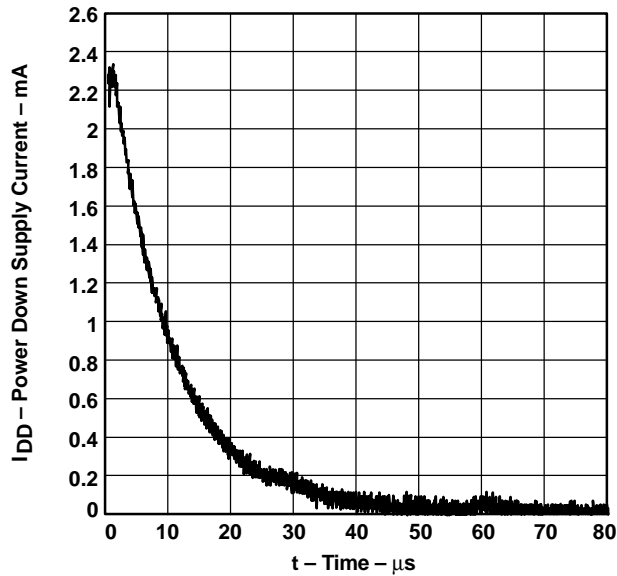

Figure 2.

SUPPLY CURRENT
VS
FREE-AIR TEMPERATURE

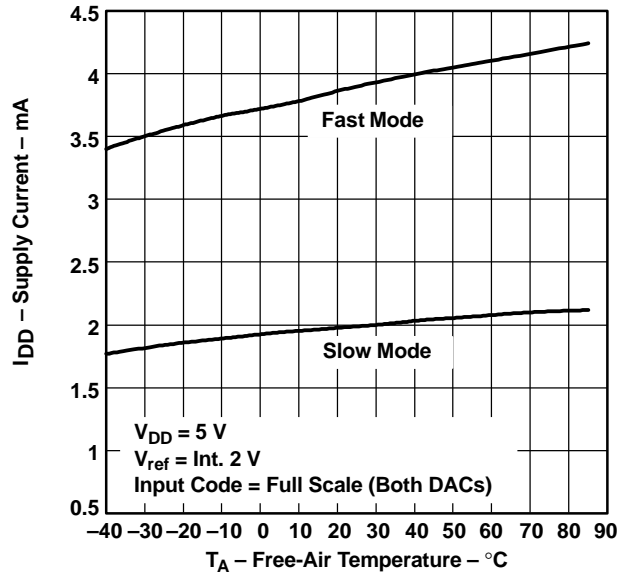

Figure 3.

SUPPLY CURRENT
VS
FREE-AIR TEMPERATURE

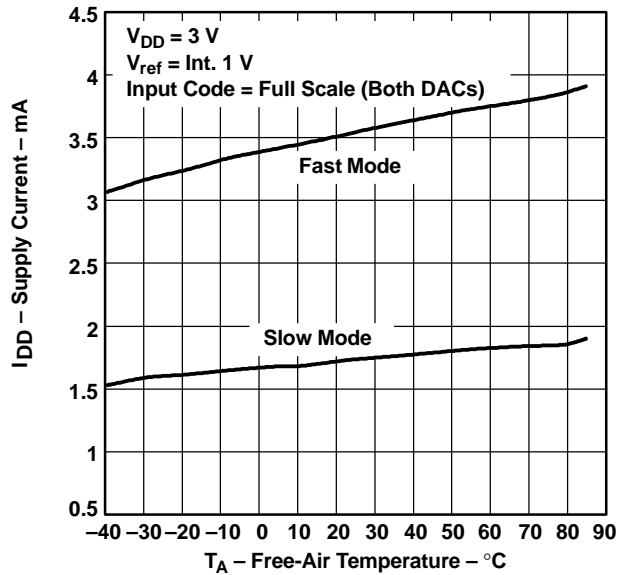

Figure 4.

OUTPUT VOLTAGE
VS
LOAD CURRENT

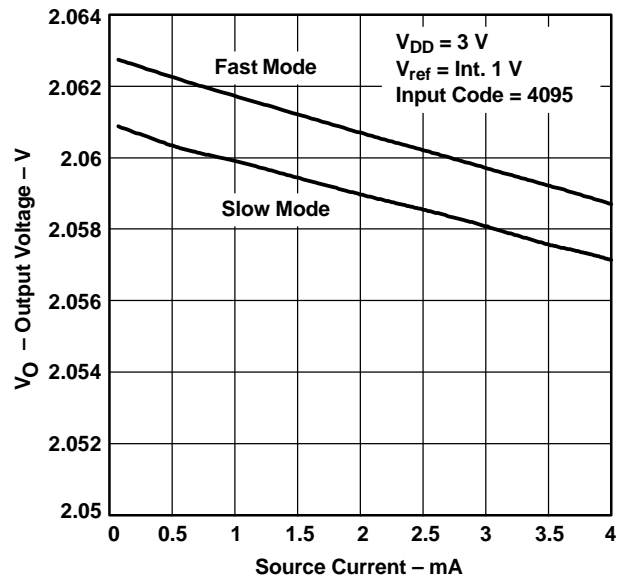

Figure 5.

TYPICAL CHARACTERISTICS (continued)

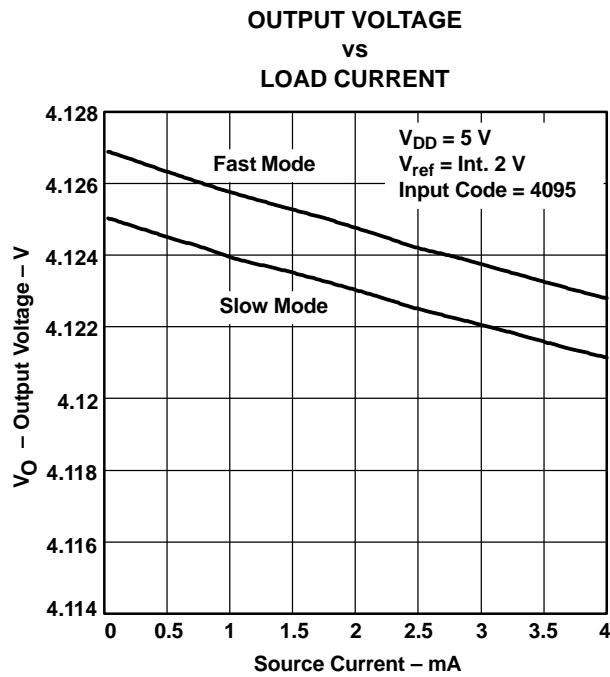

Figure 6.

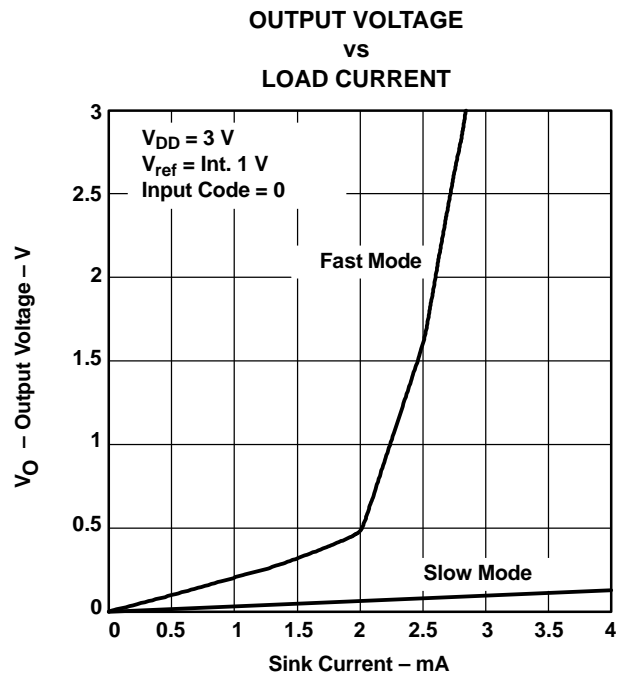

Figure 7.

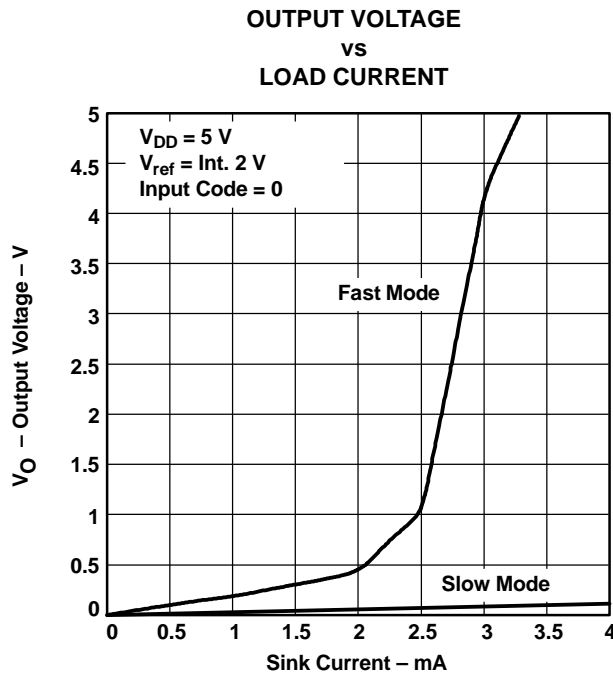

Figure 8.

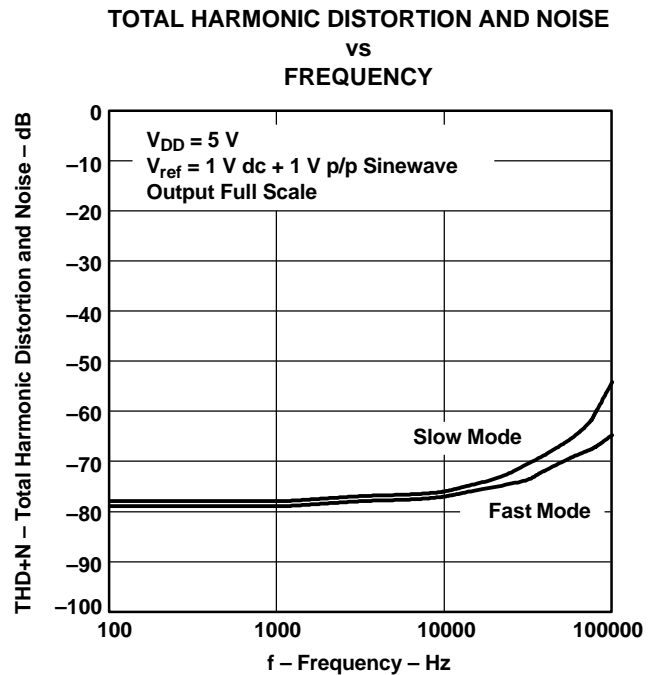

Figure 9.

TYPICAL CHARACTERISTICS (continued)

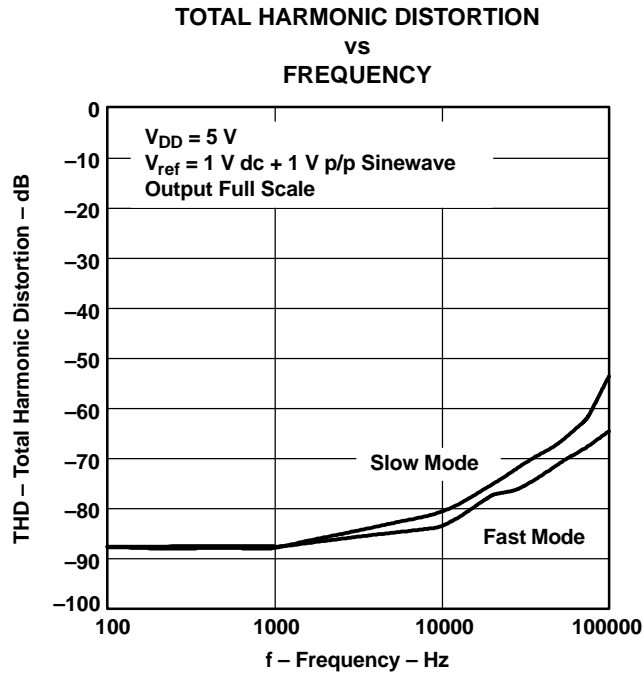
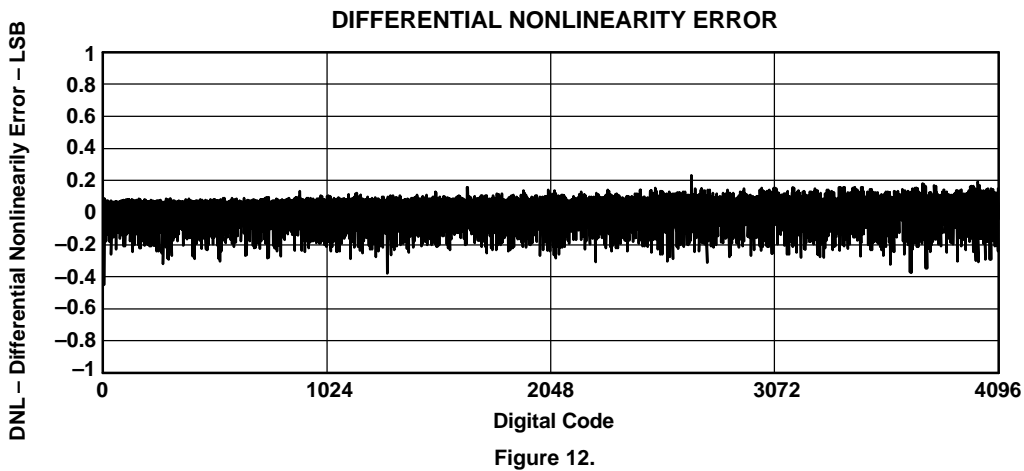
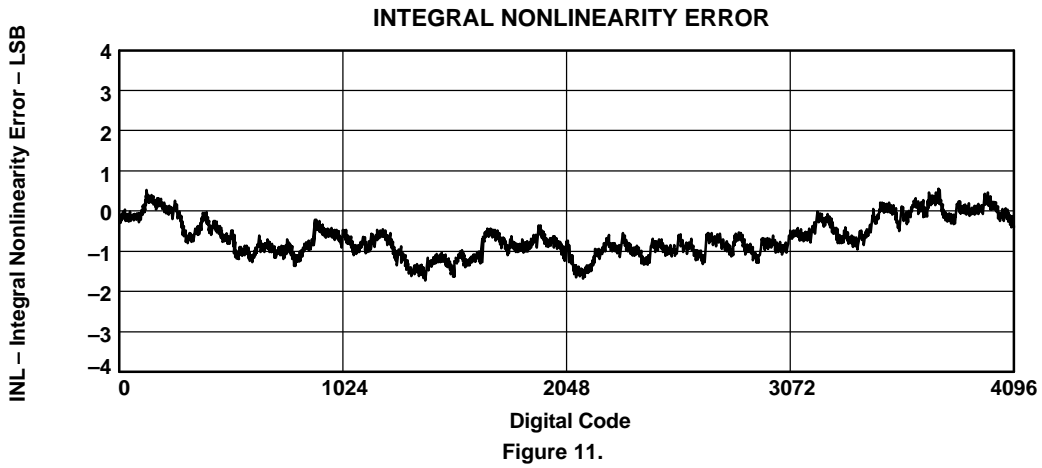

Figure 10.



APPLICATION INFORMATION

GENERAL FUNCTION

The TLV5638 is a dual 12-bit, single supply DAC, based on a resistor string architecture. It consists of a serial interface, a speed and power-down control logic, a programmable internal reference, a resistor string, and a rail-to-rail output buffer.

The output voltage (full scale determined by reference) is given by:

$$2 \text{ REF } \frac{\text{CODE}}{0x1000} \text{ [V]}$$

Where REF is the reference voltage and CODE is the digital input value in the range 0x000 to 0xFFFF. A power on reset initially puts the internal latches to a defined state (all bits zero).

SERIAL INTERFACE

A falling edge of $\overline{\text{CS}}$ starts shifting the data bit-per-bit (starting with the MSB) to the internal register on the falling edges of SCLK. After 16 bits have been transferred or $\overline{\text{CS}}$ rises, the content of the shift register is moved to the target latches (DAC A, DAC B, BUFFER, CONTROL), depending on the control bits within the data word.

Figure 13 shows examples of how to connect the TLV5638 to TMS320, SPI™, and Microwire™.

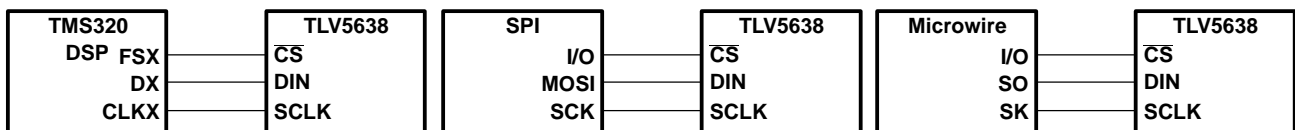

Figure 13. Three-Wire Interface

Notes on SPI™ and Microwire™: Before the controller starts the data transfer, the software has to generate a falling edge on the pin connected to $\overline{\text{CS}}$. If the word width is 8 bits (SPI™ and Microwire™), two write operations must be performed to program the TLV5638. After the write operation(s), the holding registers or the control register are updated automatically on the 16th positive clock edge.

SERIAL CLOCK FREQUENCY AND UPDATE RATE

The maximum serial clock frequency is given by:

$$f_{\text{sclkmax}} = \frac{1}{t_{\text{whmin}} + t_{\text{wlmin}}} = 20 \text{ MHz}$$

The maximum update rate is:

$$f_{\text{updatemax}} = \frac{1}{16 (t_{\text{whmin}} + t_{\text{wlmin}})} = 1.25 \text{ MHz}$$

Note, that the maximum update rate is just a theoretical value for the serial interface, as the settling time of the TLV5638 has to be considered, too.

APPLICATION INFORMATION (continued)

DATA FORMAT

The 16-bit data word for the TLV5638 consists of two parts:

- Program bits (D15..D12)
- New data (D11..D0)

D15	D14	D13	D12	D11	D10	D9	D8	D7	D6	D5	D4	D3	D2	D1	D0
R1	SPD	PWR	R0	12 Data bits											

SPD: Speed control bit 1 → fast mode 0 → slow mode
 PWR: Power control bit 1 → power down 0 → normal operation

The following table lists the possible combination of the register select bits:

REGISTERED SELECT BITS

R1	R0	REGISTER
0	0	Write data to DAC B and BUFFER
0	1	Write data to BUFFER
1	0	Write data to DAC A and update DAC B with BUFFER content
1	1	Write data to control register

The meaning of the 12 data bits depends on the register. If one of the DAC registers or the BUFFER is selected, then the 12 data bits determine the new DAC value:

DATA BITS: DAC A, DAC B and BUFFER

D11	D10	D9	D8	D7	D6	D5	D4	D3	D2	D1	D0
New DAC Value											

If control is selected, then D1, D0 of the 12 data bits are used to program the reference voltage:

DATA BITS: CONTROL

D11	D10	D9	D8	D7	D6	D5	D4	D3	D2	D1	D0
X	X	X	X	X	X	X	X	X	X	REF1	REF0

REF1 and REF0 determine the reference source and, if internal reference is selected, the reference voltage.

REFERENCE BITS

REF1	REF0	REFERENCE
0	0	External
0	1	1.024 V
1	0	2.048 V
1	1	External

CAUTION:

If external reference voltage is applied to the REF pin, external reference MUST be selected.

EXAMPLES OF OPERATION:

1. Set DAC A output, select fast mode, select internal reference at 2.048 V:

a. Set reference voltage to 2.048 V (CONTROL register)

D15	D14	D13	D12	D11	D10	D9	D8	D7	D6	D5	D4	D3	D2	D1	D0
1	1	0	1	0	0	0	0	0	0	0	0	0	0	1	0

b. Write new DAC A value and update DAC A output:

D15	D14	D13	D12	D11	D10	D9	D8	D7	D6	D5	D4	D3	D2	D1	D0
1	1	0	0	New DAC A output value											

The DAC A output is updated on the rising clock edge after D0 is sampled.

To output data consecutively using the same DAC configuration, it is not necessary to program the CONTROL register again.

2. Set DAC B output, select fast mode, select external reference:

a. Select external reference (CONTROL register):

D15	D14	D13	D12	D11	D10	D9	D8	D7	D6	D5	D4	D3	D2	D1	D0
1	1	0	1	0	0	0	0	0	0	0	0	0	0	0	0

b. Write new DAC B value to BUFFER and update DAC B output:

D15	D14	D13	D12	D11	D10	D9	D8	D7	D6	D5	D4	D3	D2	D1	D0
0	1	0	0	New BUFFER content and DAC B output value											

The DAC A output is updated on the rising clock edge after D0 is sampled.

To output data consecutively using the same DAC configuration, it is not necessary to program the CONTROL register again.

3. Set DAC A value, set DAC B value, update both simultaneously, select slow mode, select internal reference at 1.024 V:

a. Set reference voltage to 1.024 V (CONTROL register)

D15	D14	D13	D12	D11	D10	D9	D8	D7	D6	D5	D4	D3	D2	D1	D0
1	0	0	1	0	0	0	0	0	0	0	0	0	0	0	1

b. Write data for DAC B to BUFFER:

D15	D14	D13	D12	D11	D10	D9	D8	D7	D6	D5	D4	D3	D2	D1	D0
0	0	0	1	New DAC B value											

c. Write new DAC A value and update DAC A and B simultaneously:

D15	D14	D13	D12	D11	D10	D9	D8	D7	D6	D5	D4	D3	D2	D1	D0
1	0	0	0	New DAC A value											

Both outputs are updated on the rising clock edge after D0 from the DAC A data word is sampled.

To output data consecutively using the same DAC configuration, it is not necessary to program the CONTROL register again.

1. Set power-down mode:

D15	D14	D13	D12	D11	D10	D9	D8	D7	D6	D5	D4	D3	D2	D1	D0
X	X	1	X	X	X	X	X	X	X	X	X	X	X	X	X

X = Don't care

LINEARITY, OFFSET, AND GAIN ERROR USING SINGLE ENDED SUPPLIES

When an amplifier is operated from a single supply, the voltage offset can still be either positive or negative. With a positive offset, the output voltage changes on the first code change. With a negative offset, the output voltage may not change with the first code, depending on the magnitude of the offset voltage.

The output amplifier attempts to drive the output to a negative voltage. However, because the most negative supply rail is ground, the output cannot drive below ground and clamps the output at 0 V.

The output voltage then remains at zero until the input code value produces a sufficient positive output voltage to overcome the negative offset voltage, resulting in the transfer function shown in [Figure 14](#).

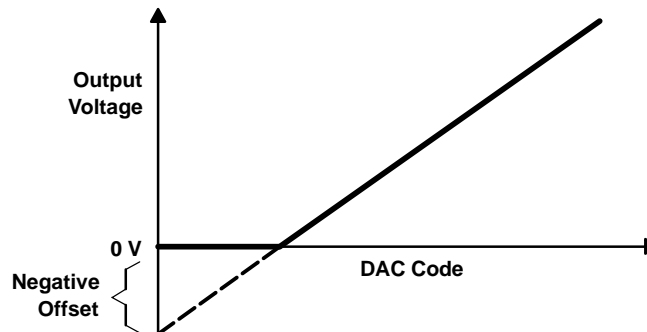

Figure 14. Effect of Negative Offset (Single Supply)

This offset error, not the linearity error, produces this breakpoint. The transfer function would have followed the dotted line if the output buffer could drive below the ground rail.

For a DAC, linearity is measured between zero-input code (all inputs 0) and full-scale code (all inputs 1) after offset and full scale are adjusted out or accounted for in some way. However, single supply operation does not allow for adjustment when the offset is negative due to the breakpoint in the transfer function. So the linearity is measured between full-scale code and the lowest code that produces a positive output voltage.

DEFINITIONS OF SPECIFICATIONS AND TERMINOLOGY

Integral Nonlinearity (INL)

The relative accuracy or integral nonlinearity (INL), sometimes referred to as linearity error, is the maximum deviation of the output from the line between zero and full scale excluding the effects of zero code and full-scale errors.

Differential Nonlinearity (DNL)

The differential nonlinearity (DNL), sometimes referred to as differential error, is the difference between the measured and ideal 1 LSB amplitude change of any two adjacent codes. Monotonic means the output voltage changes in the same direction (or remains constant) as a change in the digital input code.

Zero-Scale Error (E_{ZS})

Zero-scale error is defined as the deviation of the output from 0 V at a digital input value of 0.

Gain Error (E_G)

Gain error is the error in slope of the DAC transfer function.

Total Harmonic Distortion (THD)

THD is the ratio of the rms value of the first six harmonic components to the value of the fundamental signal. The value for THD is expressed in decibels.

Signal-to-Noise Ratio + Distortion (S/N+D)

S/N+D is the ratio of the rms value of the output signal to the rms sum of all other spectral components below the Nyquist frequency, including harmonics but excluding dc. The value for S/N+D is expressed in decibels.

Spurious Free Dynamic Range (SFDR)

Spurious free dynamic range is the difference between the rms value of the output signal and the rms value of the largest spurious signal within a specified bandwidth. The value for SFDR is expressed in decibels.

PACKAGING INFORMATION

Orderable Device	Status (1)	Package Type	Package Drawing	Pins	Package Qty	Eco Plan (2)	Lead finish/ Ball material (6)	MSL Peak Temp (3)	Op Temp (°C)	Device Marking (4/5)	Samples
5962-9957601Q2A	ACTIVE	LCCC	FK	20	1	RoHS-Exempt & Green	SNPB	N / A for Pkg Type	-55 to 125	5962-9957601Q2A TLV5638 MFKB	Samples
5962-9957601QPA	ACTIVE	CDIP	JG	8	1	Non-RoHS & Green	SNPB	N / A for Pkg Type	-55 to 125	9957601QPA TLV5638M	Samples
TLV5638CD	ACTIVE	SOIC	D	8	75	RoHS & Green	NIPDAU	Level-1-260C-UNLIM	0 to 70	5638C	Samples
TLV5638CDG4	ACTIVE	SOIC	D	8	75	RoHS & Green	NIPDAU	Level-1-260C-UNLIM	0 to 70	5638C	Samples
TLV5638CDR	ACTIVE	SOIC	D	8	2500	RoHS & Green	NIPDAU	Level-1-260C-UNLIM	0 to 70	5638C	Samples
TLV5638CDRG4	ACTIVE	SOIC	D	8	2500	RoHS & Green	NIPDAU	Level-1-260C-UNLIM	0 to 70	5638C	Samples
TLV5638ID	ACTIVE	SOIC	D	8	75	RoHS & Green	NIPDAU	Level-1-260C-UNLIM	-40 to 85	5638I	Samples
TLV5638IDG4	ACTIVE	SOIC	D	8	75	RoHS & Green	NIPDAU	Level-1-260C-UNLIM	-40 to 85	5638I	Samples
TLV5638IDR	ACTIVE	SOIC	D	8	2500	RoHS & Green	NIPDAU	Level-1-260C-UNLIM	-40 to 85	5638I	Samples
TLV5638MFKB	ACTIVE	LCCC	FK	20	1	RoHS-Exempt & Green	SNPB	N / A for Pkg Type	-55 to 125	5962-9957601Q2A TLV5638 MFKB	Samples
TLV5638MJGB	ACTIVE	CDIP	JG	8	1	Non-RoHS & Green	SNPB	N / A for Pkg Type	-55 to 125	9957601QPA TLV5638M	Samples
TLV5638QD	ACTIVE	SOIC	D	8	75	RoHS & Green	NIPDAU	Level-1-260C-UNLIM	-40 to 125	V5638	Samples
TLV5638QDG4	ACTIVE	SOIC	D	8	75	RoHS & Green	NIPDAU	Level-1-260C-UNLIM		V5638	Samples
TLV5638QDR	ACTIVE	SOIC	D	8	2500	RoHS & Green	NIPDAU	Level-1-260C-UNLIM	-40 to 125	V5638	Samples
TLV5638QDRG4	ACTIVE	SOIC	D	8	2500	RoHS & Green	NIPDAU	Level-1-260C-UNLIM		V5638	Samples

(1) The marketing status values are defined as follows:

ACTIVE: Product device recommended for new designs.

LIFEBUY: TI has announced that the device will be discontinued, and a lifetime-buy period is in effect.

NRND: Not recommended for new designs. Device is in production to support existing customers, but TI does not recommend using this part in a new design.

PREVIEW: Device has been announced but is not in production. Samples may or may not be available.

OBSOLETE: TI has discontinued the production of the device.

⁽²⁾ **RoHS:** TI defines "RoHS" to mean semiconductor products that are compliant with the current EU RoHS requirements for all 10 RoHS substances, including the requirement that RoHS substance do not exceed 0.1% by weight in homogeneous materials. Where designed to be soldered at high temperatures, "RoHS" products are suitable for use in specified lead-free processes. TI may reference these types of products as "Pb-Free".

RoHS Exempt: TI defines "RoHS Exempt" to mean products that contain lead but are compliant with EU RoHS pursuant to a specific EU RoHS exemption.

Green: TI defines "Green" to mean the content of Chlorine (Cl) and Bromine (Br) based flame retardants meet JS709B low halogen requirements of <=1000ppm threshold. Antimony trioxide based flame retardants must also meet the <=1000ppm threshold requirement.

⁽³⁾ **MSL, Peak Temp.** - The Moisture Sensitivity Level rating according to the JEDEC industry standard classifications, and peak solder temperature.

⁽⁴⁾ There may be additional marking, which relates to the logo, the lot trace code information, or the environmental category on the device.

⁽⁵⁾ Multiple Device Markings will be inside parentheses. Only one Device Marking contained in parentheses and separated by a "~" will appear on a device. If a line is indented then it is a continuation of the previous line and the two combined represent the entire Device Marking for that device.

⁽⁶⁾ **Lead finish/Ball material** - Orderable Devices may have multiple material finish options. Finish options are separated by a vertical ruled line. Lead finish/Ball material values may wrap to two lines if the finish value exceeds the maximum column width.

Important Information and Disclaimer:The information provided on this page represents TI's knowledge and belief as of the date that it is provided. TI bases its knowledge and belief on information provided by third parties, and makes no representation or warranty as to the accuracy of such information. Efforts are underway to better integrate information from third parties. TI has taken and continues to take reasonable steps to provide representative and accurate information but may not have conducted destructive testing or chemical analysis on incoming materials and chemicals. TI and TI suppliers consider certain information to be proprietary, and thus CAS numbers and other limited information may not be available for release.

In no event shall TI's liability arising out of such information exceed the total purchase price of the TI part(s) at issue in this document sold by TI to Customer on an annual basis.

OTHER QUALIFIED VERSIONS OF TLV5638, TLV5638M :

- Catalog : [TLV5638](#)
- Enhanced Product : [TLV5638-EP](#), [TLV5638-EP](#)
- Military : [TLV5638M](#)

NOTE: Qualified Version Definitions:

- Catalog - TI's standard catalog product
- Enhanced Product - Supports Defense, Aerospace and Medical Applications
- Military - QML certified for Military and Defense Applications

TAPE AND REEL INFORMATION

QUADRANT ASSIGNMENTS FOR PIN 1 ORIENTATION IN TAPE

*All dimensions are nominal

Device	Package Type	Package Drawing	Pins	SPQ	Reel Diameter (mm)	Reel Width W1 (mm)	A0 (mm)	B0 (mm)	K0 (mm)	P1 (mm)	W (mm)	Pin1 Quadrant
TLV5638CDR	SOIC	D	8	2500	330.0	12.4	6.4	5.2	2.1	8.0	12.0	Q1
TLV5638IDR	SOIC	D	8	2500	330.0	12.4	6.4	5.2	2.1	8.0	12.0	Q1
TLV5638QDR	SOIC	D	8	2500	330.0	12.4	6.4	5.2	2.1	8.0	12.0	Q1

TAPE AND REEL BOX DIMENSIONS

*All dimensions are nominal

Device	Package Type	Package Drawing	Pins	SPQ	Length (mm)	Width (mm)	Height (mm)
TLV5638CDR	SOIC	D	8	2500	350.0	350.0	43.0
TLV5638IDR	SOIC	D	8	2500	356.0	356.0	35.0
TLV5638QDR	SOIC	D	8	2500	350.0	350.0	43.0

TUBE

*All dimensions are nominal

Device	Package Name	Package Type	Pins	SPQ	L (mm)	W (mm)	T (μm)	B (mm)
5962-9957601Q2A	FK	LCCC	20	1	506.98	12.06	2030	NA
TLV5638CD	D	SOIC	8	75	505.46	6.76	3810	4
TLV5638CDG4	D	SOIC	8	75	505.46	6.76	3810	4
TLV5638ID	D	SOIC	8	75	506.6	8	3940	4.32
TLV5638IDG4	D	SOIC	8	75	506.6	8	3940	4.32
TLV5638MFKB	FK	LCCC	20	1	506.98	12.06	2030	NA
TLV5638QD	D	SOIC	8	75	505.46	6.76	3810	4
TLV5638QDG4	D	SOIC	8	75	505.46	6.76	3810	4

GENERIC PACKAGE VIEW

FK 20

LCCC - 2.03 mm max height

8.89 x 8.89, 1.27 mm pitch

LEADLESS CERAMIC CHIP CARRIER

This image is a representation of the package family, actual package may vary.
Refer to the product data sheet for package details.



4229370VA\



D0008A

PACKAGE OUTLINE

SOIC - 1.75 mm max height

SMALL OUTLINE INTEGRATED CIRCUIT



4214825/C 02/2019

NOTES:

1. Linear dimensions are in inches [millimeters]. Dimensions in parenthesis are for reference only. Controlling dimensions are in inches. Dimensioning and tolerancing per ASME Y14.5M.
2. This drawing is subject to change without notice.
3. This dimension does not include mold flash, protrusions, or gate burrs. Mold flash, protrusions, or gate burrs shall not exceed $.006$ [0.15] per side.
4. This dimension does not include interlead flash.
5. Reference JEDEC registration MS-012, variation AA.

EXAMPLE BOARD LAYOUT

D0008A

SOIC - 1.75 mm max height

SMALL OUTLINE INTEGRATED CIRCUIT



LAND PATTERN EXAMPLE
 EXPOSED METAL SHOWN
 SCALE:8X



SOLDER MASK DETAILS

4214825/C 02/2019

NOTES: (continued)

- 6. Publication IPC-7351 may have alternate designs.
- 7. Solder mask tolerances between and around signal pads can vary based on board fabrication site.

EXAMPLE STENCIL DESIGN

D0008A

SOIC - 1.75 mm max height

SMALL OUTLINE INTEGRATED CIRCUIT

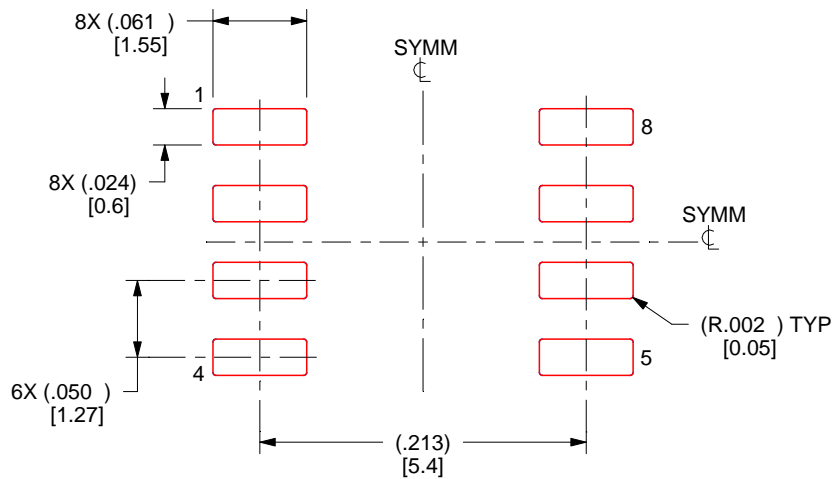

SOLDER PASTE EXAMPLE
BASED ON .005 INCH [0.125 MM] THICK STENCIL
SCALE:8X

4214825/C 02/2019

NOTES: (continued)

8. Laser cutting apertures with trapezoidal walls and rounded corners may offer better paste release. IPC-7525 may have alternate design recommendations.
9. Board assembly site may have different recommendations for stencil design.

JG (R-GDIP-T8)

CERAMIC DUAL-IN-LINE

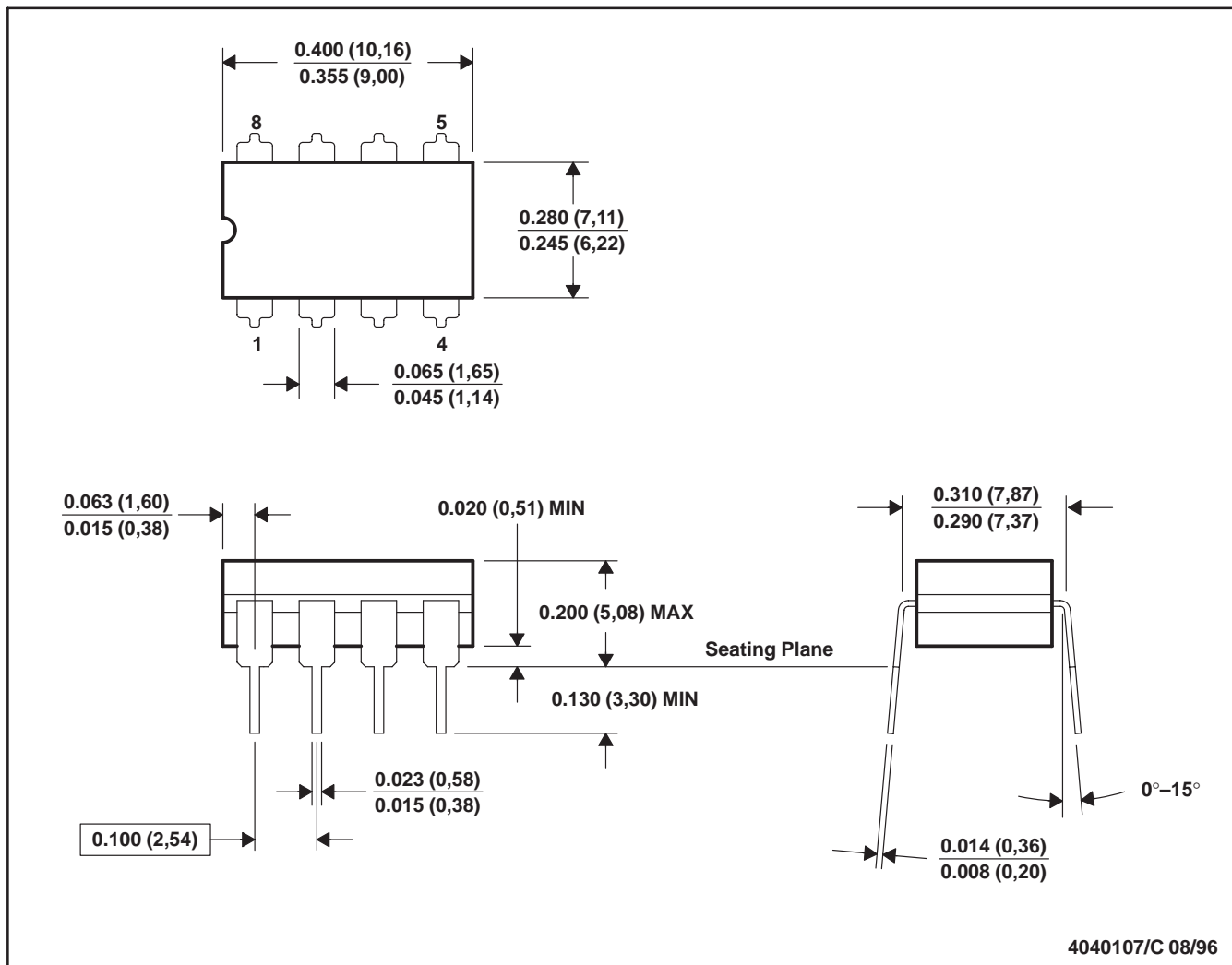

- NOTES: A. All linear dimensions are in inches (millimeters).
 B. This drawing is subject to change without notice.
 C. This package can be hermetically sealed with a ceramic lid using glass frit.
 D. Index point is provided on cap for terminal identification.
 E. Falls within MIL STD 1835 GDIP1-T8

IMPORTANT NOTICE AND DISCLAIMER

TI PROVIDES TECHNICAL AND RELIABILITY DATA (INCLUDING DATA SHEETS), DESIGN RESOURCES (INCLUDING REFERENCE DESIGNS), APPLICATION OR OTHER DESIGN ADVICE, WEB TOOLS, SAFETY INFORMATION, AND OTHER RESOURCES "AS IS" AND WITH ALL FAULTS, AND DISCLAIMS ALL WARRANTIES, EXPRESS AND IMPLIED, INCLUDING WITHOUT LIMITATION ANY IMPLIED WARRANTIES OF MERCHANTABILITY, FITNESS FOR A PARTICULAR PURPOSE OR NON-INFRINGEMENT OF THIRD PARTY INTELLECTUAL PROPERTY RIGHTS.

These resources are intended for skilled developers designing with TI products. You are solely responsible for (1) selecting the appropriate TI products for your application, (2) designing, validating and testing your application, and (3) ensuring your application meets applicable standards, and any other safety, security, regulatory or other requirements.

These resources are subject to change without notice. TI grants you permission to use these resources only for development of an application that uses the TI products described in the resource. Other reproduction and display of these resources is prohibited. No license is granted to any other TI intellectual property right or to any third party intellectual property right. TI disclaims responsibility for, and you will fully indemnify TI and its representatives against, any claims, damages, costs, losses, and liabilities arising out of your use of these resources.

TI's products are provided subject to [TI's Terms of Sale](#) or other applicable terms available either on [ti.com](https://www.ti.com) or provided in conjunction with such TI products. TI's provision of these resources does not expand or otherwise alter TI's applicable warranties or warranty disclaimers for TI products.

TI objects to and rejects any additional or different terms you may have proposed.

Mailing Address: Texas Instruments, Post Office Box 655303, Dallas, Texas 75265
Copyright © 2023, Texas Instruments Incorporated