

## +3.3V Programmable LVDS Transmitter 18-Bit Flat Panel Display (FPD) Link -65 MHz

Check for Samples: [DS90C363B](#)

### FEATURES

- **No special start-up sequence required between clock/data and /PD pins. Input signal (clock and data) can be applied either before or after the device is powered.**
- **Support Spread Spectrum Clocking up to 100kHz frequency modulation and deviations of  $\pm 2.5\%$  center spread or  $-5\%$  down spread.**
- **"Input Clock Detection" feature will pull all LVDS pairs to logic low when input clock is missing and when /PD pin is logic high.**
- **18 to 68 MHz shift clock support**
- **Best-in-Class Set & Hold Times on TxINPUTs**
- **Tx power consumption < 130 mW (typ) at 65MHz Grayscale**
- **40% Less Power Dissipation than BiCMOS Alternatives**
- **Tx Power-down mode < 37 $\mu$ W (typ)**
- **Supports VGA, SVGA, XGA and Dual Pixel SXGA.**
- **Narrow bus reduces cable size and cost**
- **Up to 1.3 Gbps throughput**
- **Up to 170 Megabytes/sec bandwidth**
- **345 mV (typ) swing LVDS devices for low EMI**
- **PLL requires no external components**
- **Compatible with TIA/EIA-644 LVDS standard**
- **Low profile 48-lead TSSOP package**
- **Improved replacement for:**
  - SN75LVDS84, DS90C363A

### DESCRIPTION

The DS90C363B transmitter converts 21 bits of CMOS/TTL data into three LVDS (Low Voltage Differential Signaling) data streams. A phase-locked transmit clock is transmitted in parallel with the data streams over a fourth LVDS link. Every cycle of the transmit clock 21 bits of input data are sampled and transmitted. At a transmit clock frequency of 65 MHz, 18 bits of RGB data and 3 bits of LCD timing and control data (FPLINE, FPFRAME, DRDY) are transmitted at a rate of 455 Mbps per LVDS data channel. Using a 65 MHz clock, the data throughput is 170 Mbytes/sec. The DS90C363B transmitter can be programmed for Rising edge strobe or Falling edge strobe through a dedicated pin. A Rising edge or Falling edge strobe transmitter will interoperate with a Falling edge strobe Receiver (DS90CF366) without any translation logic.

This chipset is an ideal means to solve EMI and cable size problems associated with wide, high speed TTL interfaces.



Please be aware that an important notice concerning availability, standard warranty, and use in critical applications of Texas Instruments semiconductor products and disclaimers thereto appears at the end of this data sheet.

TRI-STATE is a registered trademark of Texas Instruments.  
All other trademarks are the property of their respective owners.

## Block Diagram

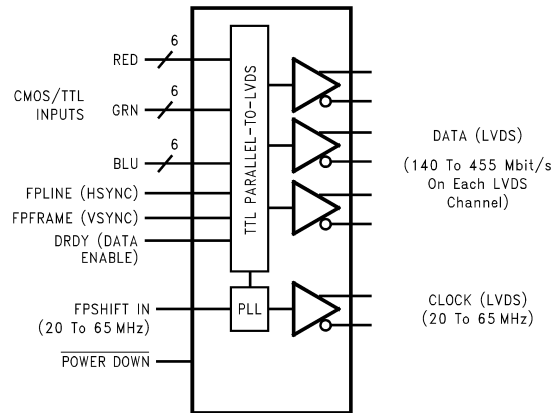

Figure 1. DS90C363B



These devices have limited built-in ESD protection. The leads should be shorted together or the device placed in conductive foam during storage or handling to prevent electrostatic damage to the MOS gates.

## Absolute Maximum Ratings <sup>(1)</sup>

Supply Voltage ( $V_{CC}$ )		-0.3V to +4 V
CMOS/TTL Input Voltage		-0.3V to ( $V_{CC} + 0.3$ ) V
LVDS Driver Output Voltage		-0.3V to ( $V_{CC} + 0.3$ ) V
LVDS Output Short Circuit Duration		Continuous
Junction Temperature		+150 °C
Storage Temperature		-65°C to +150 °C
Lead Temperature (Soldering, 4 sec)		+260 °C
Maximum Package Power Dissipation Capacity at 25°C	TSSOP Package	1.98 W
Package Power Dissipation Derating		16 mW/°C above +25°C
ESD Rating	HBM, 1.5 k $\Omega$ , 100 pF	7 kV
	EIAJ, 0 $\Omega$ , 200 pF	500 V

(1) "Absolute Maximum Ratings" are those values beyond which the safety of the device cannot be verified. They are not meant to imply that the device should be operated at these limits. The tables of "Electrical Characteristics" specify conditions for device operation.

## Recommended Operating Conditions

	Min	Nom	Max	Unit
Supply Voltage ( $V_{CC}$ )	3.0	3.3	3.6	V
Operating Free Air Temperature ( $T_A$ )	-10	+25	+70	°C
Supply Noise Voltage ( $V_{CC}$ )			200	mV <sub>PP</sub>
TxCLKIN frequency	18		68	MHz

## Electrical Characteristics<sup>(1)</sup>

Over recommended operating supply and temperature ranges unless otherwise specified.

Symbol	Parameter	Conditions	Min	Typ <sup>(2)</sup>	Max	Unit	
<b>CMOS/TTL DC SPECIFICATIONS</b>							
V <sub>IH</sub>	High Level Input Voltage		2.0		V <sub>CC</sub>	V	
V <sub>IL</sub>	Low Level Input Voltage		GND		0.8	V	
V <sub>CL</sub>	Input Clamp Voltage	I <sub>CL</sub> = -18 mA		-0.79	-1.5	V	
I <sub>IN</sub>	Input Current	V <sub>IN</sub> = 0.4V, 2.5V or V <sub>CC</sub>		+1.8	+10	μA	
		V <sub>IN</sub> = GND	-10	0		μA	
<b>LVDS DC SPECIFICATIONS</b>							
V <sub>OD</sub>	Differential Output Voltage	R <sub>L</sub> = 100Ω	250	345	450	mV	
ΔV <sub>OD</sub>	Change in V <sub>OD</sub> between complimentary output states				35	mV	
V <sub>OS</sub>	Offset Voltage <sup>(3)</sup>		1.13	1.25	1.38	V	
ΔV <sub>OS</sub>	Change in V <sub>OS</sub> between complimentary output states				35	mV	
I <sub>OS</sub>	Output Short Circuit Current	V <sub>OUT</sub> = 0V, R <sub>L</sub> = 100Ω		-3.5	-5	mA	
I <sub>OZ</sub>	Output TRI-STATE <sup>®</sup> Current	Power Down = 0V, V <sub>OUT</sub> = 0V or V <sub>CC</sub>		±1	±10	μA	
<b>TRANSMITTER SUPPLY CURRENT</b>							
ICCTW	Transmitter Supply Current, Worst Case	R <sub>L</sub> = 100Ω, C <sub>L</sub> = 5 pF, Worst Case Pattern (Figure 2 Figure 5) "Typ" values are given for V <sub>CC</sub> = 3.6V and T <sub>A</sub> = +25°C, "Max" values are given for V <sub>CC</sub> = 3.6V and T <sub>A</sub> = -10°C	f = 25MHz		29	40	mA
			f = 40 MHz		34	45	mA
			f = 65 MHz		42	55	mA
ICCTG	Transmitter Supply Current, 16 Grayscale	R <sub>L</sub> = 100Ω, C <sub>L</sub> = 5 pF, 16 Grayscale Pattern (Figure 3 Figure 5) "Typ" values are given for V <sub>CC</sub> = 3.6V and T <sub>A</sub> = +25°C, "Max" values are given for V <sub>CC</sub> = 3.6V and T <sub>A</sub> = -10°C	f = 25 MHz		28	40	mA
			f = 40 MHz		32	45	mA
			f = 65 MHz		39	50	mA
ICCTZ	Transmitter Supply Current, Power Down	Power Down = Low Driver Outputs in TRI-STATE <sup>®</sup> under Power Down Mode		11	150	μA	

(1) Current into device pins is defined as positive. Current out of device pins is defined as negative. Voltages are referenced to ground unless otherwise specified (except V<sub>OD</sub> and ΔV<sub>OD</sub>).

(2) Typical values are given for V<sub>CC</sub> = 3.3V and T<sub>A</sub> = +25°C unless specified otherwise.

(3) V<sub>OS</sub> previously referred as V<sub>CM</sub>.

## Recommended Transmitter Input Characteristics

Over recommended operating supply and temperature ranges unless otherwise specified

Symbol	Parameter	Min	Typ	Max	Unit
TCIT	TxCLK IN Transition Time (Figure 6)			5	ns
TCIP	TxCLK IN Period (Figure 7)	14.7	T	50	ns
TCIH	TxCLK IN High Time (Figure 7)	0.35T	0.5T	0.65T	ns
TCIL	TxCLK IN Low Time (Figure 7)	0.35T	0.5T	0.65T	ns
TXIT	TxIN, and Power Down pin transition Time	1.5		6.0	ns
TXPD	Minimum pulse width for Power Down pin signal	1			μs

## Transmitter Switching Characteristics

Over recommended operating supply and temperature ranges unless otherwise specified

Symbol	Parameter	Min	Typ	Max	Unit
LLHT	LVDS Low-to-High Transition Time (Figure 5 )		0.75	1.4	ns
LHLT	LVDS High-to-Low Transition Time (Figure 5 )		0.75	1.4	ns
TPPos0	Transmitter Output Pulse Position for Bit 0 (Figure 12 ) <sup>(1)</sup>	-0.20	0	+0.20	ns
TPPos1	Transmitter Output Pulse Position for Bit 1	2.00	2.20	2.40	ns
TPPos2	Transmitter Output Pulse Position for Bit 2	4.20	4.40	4.60	ns
TPPos3	Transmitter Output Pulse Position for Bit 3	6.39	6.59	6.79	ns
TPPos4	Transmitter Output Pulse Position for Bit 4	8.59	8.79	8.99	ns
TPPos5	Transmitter Output Pulse Position for Bit 5	10.79	10.99	11.19	ns
TPPos6	Transmitter Output Pulse Position for Bit 6	12.99	13.19	13.39	ns
TPPos0	Transmitter Output Pulse Position for Bit 0 (Figure 12 ) <sup>(1)</sup>	-0.25	0	+0.25	ns
TPPos1	Transmitter Output Pulse Position for Bit 1	3.32	3.57	3.82	ns
TPPos2	Transmitter Output Pulse Position for Bit 2	6.89	7.14	7.39	ns
TPPos3	Transmitter Output Pulse Position for Bit 3	10.46	10.71	10.96	ns
TPPos4	Transmitter Output Pulse Position for Bit 4	14.04	14.29	14.54	ns
TPPos5	Transmitter Output Pulse Position for Bit 5	17.61	17.86	18.11	ns
TPPos6	Transmitter Output Pulse Position for Bit 6	21.18	21.43	21.68	ns
TPPos0	Transmitter Output Pulse Position for Bit 0 (Figure 12 ) <sup>(1)</sup>	-0.45	0	+0.45	ns
TPPos1	Transmitter Output Pulse Position for Bit 1	5.26	5.71	6.16	ns
TPPos2	Transmitter Output Pulse Position for Bit 2	10.98	11.43	11.88	ns
TPPos3	Transmitter Output Pulse Position for Bit 3	16.69	17.14	17.59	ns
TPPos4	Transmitter Output Pulse Position for Bit 4	22.41	22.86	23.31	ns
TPPos5	Transmitter Output Pulse Position for Bit 5	28.12	28.57	29.02	ns
TPPos6	Transmitter Output Pulse Position for Bit 6	33.84	34.29	34.74	ns
TSTC	TxIN Setup to TxCLK IN (Figure 7 )	2.5			ns
THTC	TxIN Hold to TxCLK IN (Figure 7 )	0.5			ns
TCCD	TxCLK IN to TxCLK OUT Delay (Figure 8 ) 50% duty cycle input clock is assumed, T <sub>A</sub> = -10°C, and 65MHz for "Min", T <sub>A</sub> = 70°C, and 25MHz for "Max", V <sub>CC</sub> = 3.6V, R <sub>FB</sub> = V <sub>CC</sub>	3.340		7.211	ns
	TxCLK IN to TxCLK OUT Delay (Figure 8 ) 50% duty cycle input clock is assumed, T <sub>A</sub> = -10°C, and 65MHz for "Min", T <sub>A</sub> = 70°C, and 25MHz for "Max", V <sub>CC</sub> = 3.6V, R <sub>FB</sub> = GND	3.011		6.062	ns
SSCG	Spread Spectrum Clock support; Modulation frequency with a linear profile <sup>(2)</sup>	f = 25 MHz	100kHz ± 2.5%/-5%		
		f = 40 MHz	100kHz ± 2.5%/-5%		
		f = 65 MHz	100kHz ± 2.5%/-5%		
TPLLS	Transmitter Phase Lock Loop Set (Figure 9 )			10	ms
TPDD	Transmitter Power Down Delay (Figure 11 )			100	ns

- (1) The Minimum and Maximum Limits are based on statistical analysis of the device performance over process, voltage, and temperature ranges. This parameter is functionality tested only on Automatic Test Equipment (ATE).
- (2) Care must be taken to ensure TSTC and THTC are met so input data are sampling correctly. This SSCG parameter only shows the performance of tracking Spread Spectrum Clock applied to TxCLK IN pin, and reflects the result on TxCLKOUT+ and TxCLK- pins.

### AC Timing Diagrams

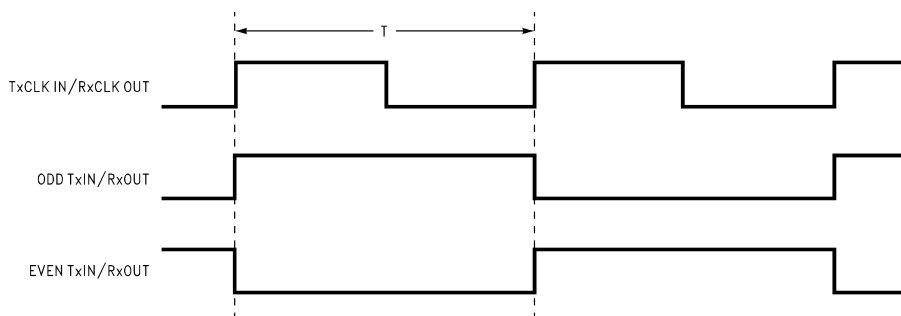

Figure 2. "Worst Case" Test Pattern

Device Pin Name	Signal	Signal Pattern	Signal Frequency
TxCLK IN/RxCLK OUT	Dot Clk	[Square Wave]	f
TxIN0/RxOUT0	R0	[High]	f/16
TxIN1/RxOUT1	R1	[High]	f/8
TxIN2/RxOUT2	R2	[High]	f/4
TxIN3/RxOUT3	R3	[High]	f/2
TxIN4/RxOUT4	R4	[Steady State, Low]	
TxIN5/RxOUT5	R5	[Steady State, Low]	
TxIN6/RxOUT6	G0	[High]	f/16
TxIN7/RxOUT7	G1	[High]	f/8
TxIN8/RxOUT8	G2	[High]	f/4
TxIN9/RxOUT9	G3	[High]	f/2
TxIN10/RxOUT10	G4	[Steady State, Low]	
TxIN11/RxOUT11	G5	[Steady State, Low]	
TxIN12/RxOUT12	B0	[High]	f/16
TxIN13/RxOUT13	B1	[High]	f/8
TxIN14/RxOUT14	B2	[High]	f/4
TxIN15/RxOUT15	B3	[High]	f/2
TxIN16/RxOUT16	B4	[Steady State, Low]	
TxIN17/RxOUT17	B5	[Steady State, Low]	
TxIN18/RxOUT18	HSYNC	[Steady State, High]	
TxIN19/RxOUT19	VSYNC	[Steady State, High]	
TxIN20/RxOUT20	ENA	[Steady State, High]	

- A. The worst case test pattern produces a maximum toggling of digital circuits, LVDS I/O and CMOS/TTL I/O.
- B. The 16 grayscale test pattern tests device power consumption for a "typical" LCD display pattern. The test pattern approximates signal switching needed to produce groups of 16 vertical stripes across the display.
- C. Figure 2 and Figure 3 show a falling edge data strobe (TxCLK IN/RxCLK OUT).
- D. Recommended pin to signal mapping. Customer may choose to define differently.

Figure 3. "16 Grayscale" Test Pattern

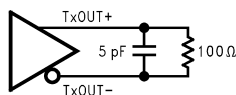

Figure 4. DS90C363B (Transmitter) LVDS Output Load

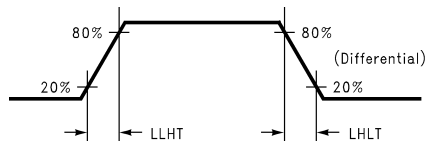

Figure 5. DS90C363B (Transmitter) LVDS Transition Times

AC Timing Diagrams (continued)

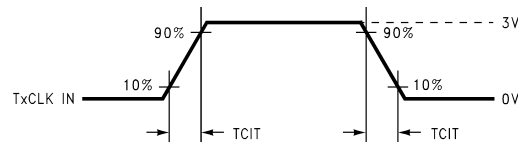

Figure 6. DS90C363B (Transmitter) Input Clock Transition Time

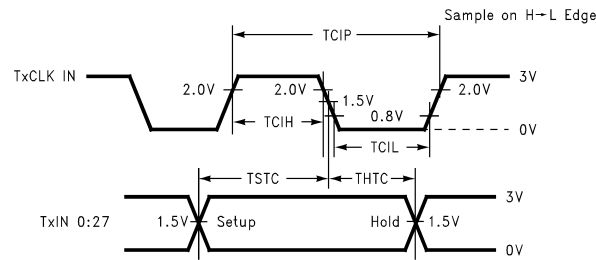

Figure 7. DS90C363B (Transmitter) Setup/Hold and High/Low Times (Falling Edge Strobe)

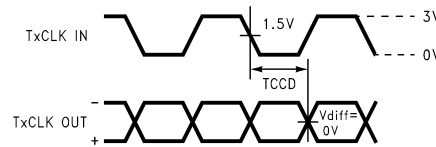

Figure 8. DS90C363B (Transmitter) Clock In to Clock Out Delay (Falling Edge Strobe)

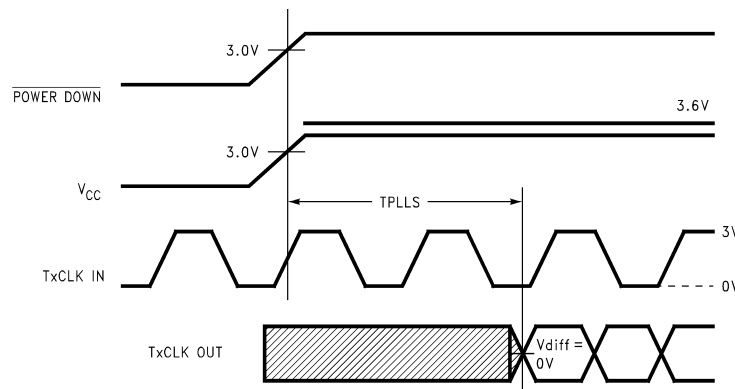

Figure 9. DS90C363B (Transmitter) Phase Lock Loop Set Time

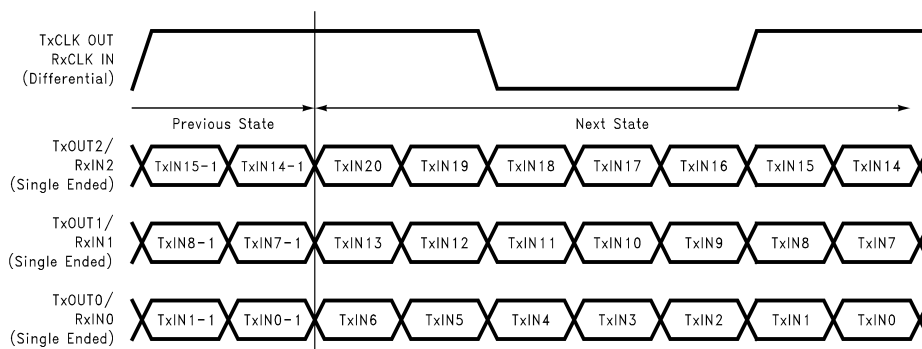

Figure 10. 21 Parallel TTL Data Inputs Mapped to LVDS Outputs

AC Timing Diagrams (continued)

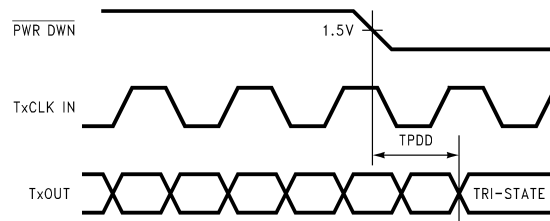

Figure 11. Transmitter Power Down Delay

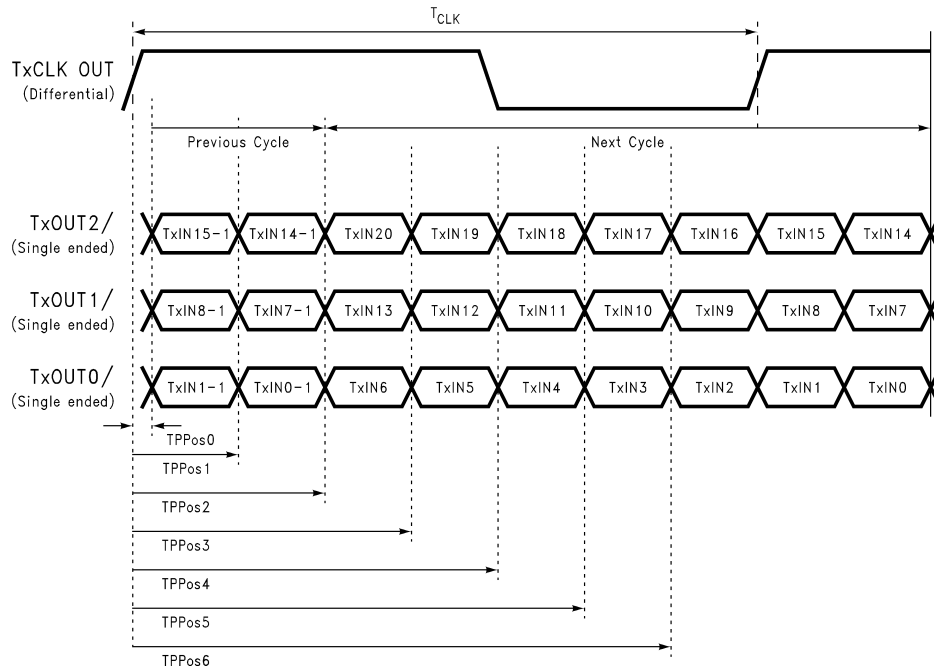

Figure 12. Transmitter LVDS Output Pulse Position Measurement

**DS90C363B Pin Descriptions — FPD Link Transmitter**

Pin Name	I/O	No.	Description
TxIN	I	21	TTL level input. This includes: 6 Red, 6 Green, 6 Blue, and 3 control lines—FPLINE, FPFRAME and DRDY (also referred to as HSYNC, VSYNC, Data Enable).
TxOUT+	O	3	Positive LVDS differential data output.
TxOUT-	O	3	Negative LVDS differential data output.
FPSHIFT IN	I	1	TTL level clock input. The falling edge acts as data strobe. Pin name TxCLK IN.
R_FB	I	1	Programmable strobe select (See <a href="#">Table 1</a> ).
TxCLK OUT+	O	1	Positive LVDS differential clock output.
TxCLK OUT-	O	1	Negative LVDS differential clock output.
PWR DOWN	I	1	TTL level input. Assertion (low input) TRI-STATES the outputs, ensuring low current at power down. See <a href="#">Applications Information</a> .
V <sub>CC</sub>	I	3	Power supply pins for TTL inputs.
GND	I	4	Ground pins for TTL inputs.
PLL V <sub>CC</sub>	I	1	Power supply pin for PLL.
PLL GND	I	2	Ground pins for PLL.
LVDS V <sub>CC</sub>	I	1	Power supply pin for LVDS outputs.
LVDS GND	I	3	Ground pins for LVDS outputs.
NC		1	No connect



## APPLICATIONS INFORMATION

The DS90C363B are backward compatible with the DS90C363/DS90CF363, DS90C363A/DS90CF363A and are a pin-for-pin replacement.

This device may also be used as a replacement for the DS90CF563 (5V, 65MHz) and DS90CF561 (5V, 40MHz) FPD-Link Transmitters with certain considerations/modifications:

1. Change 5V power supply to 3.3V. Provide this supply to the  $V_{CC}$ , LVDS  $V_{CC}$  and PLL  $V_{CC}$  of the transmitter.
2. To implement a falling edge device for the DS90C363B, the R\_FB pin (pin 14) may be tied to ground OR left unconnected (an internal pull-down resistor biases this pin low). Biasing this pin to  $V_{CC}$  implements a rising edge device.

### TRANSMITTER INPUT PINS

The DS90C363B transmitter input and control inputs accept 3.3V LVTTTL/LVCMOS levels. They are not 5V tolerant.

### TRANSMITTER INPUT CLOCK/DATA SEQUENCING

The DS90C363B does not require any special requirement for sequencing of the input clock/data and PD (PowerDown) signal. The DS90C363B offers a more robust input sequencing feature where the input clock/data can be inserted after the release of the PD signal. In the case where the clock/data is stopped and reapplied, such as changing video mode within Graphics Controller, it is not necessary to cycle the PD signal. However, there are in certain cases where the PD may need to be asserted during these mode changes. In cases where the source (Graphics Source) may be supplying an unstable clock or spurious noisy clock output to the LVDS transmitter, the LVDS Transmitter may attempt to lock onto this unstable clock signal but is unable to do so due the instability or quality of the clock source. The PD signal in these cases should then be asserted once a stable clock is applied to the LVDS transmitter. Asserting the PWR DOWN pin will effectively place the device in reset and disable the PLL, enabling the LVDS Transmitter into a power saving standby mode. However, it is still generally a good practice to assert the PWR DOWN pin or reset the LVDS transmitter whenever the clock/data is stopped and reapplied but it is not mandatory for the DS90C363B.

### SPREAD SPECTRUM CLOCK SUPPORT

The DS90C363B can support Spread Spectrum Clocking signal type inputs. The DS90C363B outputs will accurately track Spread Spectrum Clock/Data inputs with modulation frequencies of up to 100kHz (max.) with either center spread of  $\pm 2.5\%$  or down spread -5% deviations.

### POWER SOURCES SEQUENCE

In typical applications, it is recommended to have  $V_{CC}$ , LVDS  $V_{CC}$  and PLL  $V_{CC}$  from the same power source with three separate de-coupling bypass capacitor groups. There is no requirement on which VCC entering the device first.

Pin Diagram

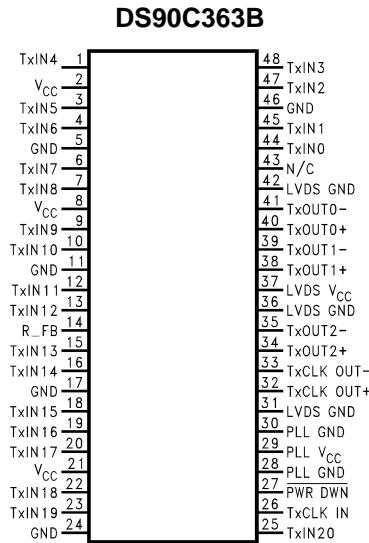

**Order Number DS90C363BMT  
DGG Package**

Typical Application

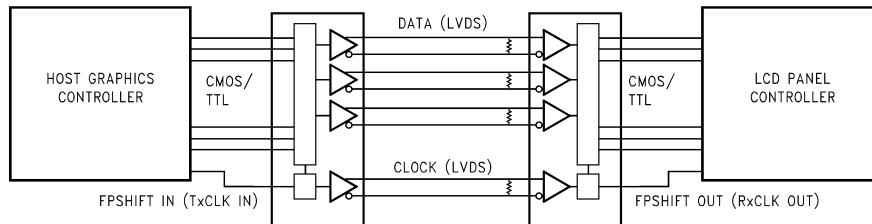

**Table 1. Programmable Transmitter (DS90C363B)**

Pin	Condition	Strobe Status
R_FB	R_FB = V <sub>CC</sub>	Rising edge strobe
R_FB	R_FB = GND or NC	Falling edge strobe

---

**REVISION HISTORY**

<b>Changes from Revision E (April 2013) to Revision F</b>	<b>Page</b>
<hr/> <ul style="list-style-type: none"><li>• Changed layout of National Data Sheet to TI format .....</li></ul>	<hr/> <a href="#">10</a>

## PACKAGING INFORMATION

Orderable Device	Status (1)	Package Type	Package Drawing	Pins	Package Qty	Eco Plan (2)	Lead finish/ Ball material (6)	MSL Peak Temp (3)	Op Temp (°C)	Device Marking (4/5)	Samples
DS90C363BMT	NRND	TSSOP	DGG	48	38	Non-RoHS & Green	Call TI	Level-2-235C-1 YEAR	-10 to 70	DS90C363BMT	
DS90C363BMT/NOPB	ACTIVE	TSSOP	DGG	48	38	RoHS & Green	SN	Level-2-260C-1 YEAR	-10 to 70	DS90C363BMT	Samples
DS90C363BMTX/NOPB	ACTIVE	TSSOP	DGG	48	1000	RoHS & Green	SN	Level-2-260C-1 YEAR	-10 to 70	DS90C363BMT	Samples

(1) The marketing status values are defined as follows:

**ACTIVE:** Product device recommended for new designs.

**LIFEBUY:** TI has announced that the device will be discontinued, and a lifetime-buy period is in effect.

**NRND:** Not recommended for new designs. Device is in production to support existing customers, but TI does not recommend using this part in a new design.

**PREVIEW:** Device has been announced but is not in production. Samples may or may not be available.

**OBSOLETE:** TI has discontinued the production of the device.

(2) **RoHS:** TI defines "RoHS" to mean semiconductor products that are compliant with the current EU RoHS requirements for all 10 RoHS substances, including the requirement that RoHS substance do not exceed 0.1% by weight in homogeneous materials. Where designed to be soldered at high temperatures, "RoHS" products are suitable for use in specified lead-free processes. TI may reference these types of products as "Pb-Free".

**RoHS Exempt:** TI defines "RoHS Exempt" to mean products that contain lead but are compliant with EU RoHS pursuant to a specific EU RoHS exemption.

**Green:** TI defines "Green" to mean the content of Chlorine (Cl) and Bromine (Br) based flame retardants meet JS709B low halogen requirements of <=1000ppm threshold. Antimony trioxide based flame retardants must also meet the <=1000ppm threshold requirement.

(3) MSL, Peak Temp. - The Moisture Sensitivity Level rating according to the JEDEC industry standard classifications, and peak solder temperature.

(4) There may be additional marking, which relates to the logo, the lot trace code information, or the environmental category on the device.

(5) Multiple Device Markings will be inside parentheses. Only one Device Marking contained in parentheses and separated by a "~" will appear on a device. If a line is indented then it is a continuation of the previous line and the two combined represent the entire Device Marking for that device.

(6) Lead finish/Ball material - Orderable Devices may have multiple material finish options. Finish options are separated by a vertical ruled line. Lead finish/Ball material values may wrap to two lines if the finish value exceeds the maximum column width.

**Important Information and Disclaimer:**The information provided on this page represents TI's knowledge and belief as of the date that it is provided. TI bases its knowledge and belief on information provided by third parties, and makes no representation or warranty as to the accuracy of such information. Efforts are underway to better integrate information from third parties. TI has taken and continues to take reasonable steps to provide representative and accurate information but may not have conducted destructive testing or chemical analysis on incoming materials and chemicals. TI and TI suppliers consider certain information to be proprietary, and thus CAS numbers and other limited information may not be available for release.

In no event shall TI's liability arising out of such information exceed the total purchase price of the TI part(s) at issue in this document sold by TI to Customer on an annual basis.

**TAPE AND REEL INFORMATION**

**QUADRANT ASSIGNMENTS FOR PIN 1 ORIENTATION IN TAPE**

\*All dimensions are nominal

Device	Package Type	Package Drawing	Pins	SPQ	Reel Diameter (mm)	Reel Width W1 (mm)	A0 (mm)	B0 (mm)	K0 (mm)	P1 (mm)	W (mm)	Pin1 Quadrant
DS90C363BMTX/NOPB	TSSOP	DGG	48	1000	330.0	24.4	8.6	13.2	1.6	12.0	24.0	Q1

**TAPE AND REEL BOX DIMENSIONS**

\*All dimensions are nominal

Device	Package Type	Package Drawing	Pins	SPQ	Length (mm)	Width (mm)	Height (mm)
DS90C363BMTX/NOPB	TSSOP	DGG	48	1000	367.0	367.0	45.0

**TUBE**

\*All dimensions are nominal

Device	Package Name	Package Type	Pins	SPQ	L (mm)	W (mm)	T (μm)	B (mm)
DS90C363BMT	DGG	TSSOP	48	38	495	10	2540	5.79
DS90C363BMT	DGG	TSSOP	48	38	495	10	2540	5.79
DS90C363BMT/NOPB	DGG	TSSOP	48	38	495	10	2540	5.79



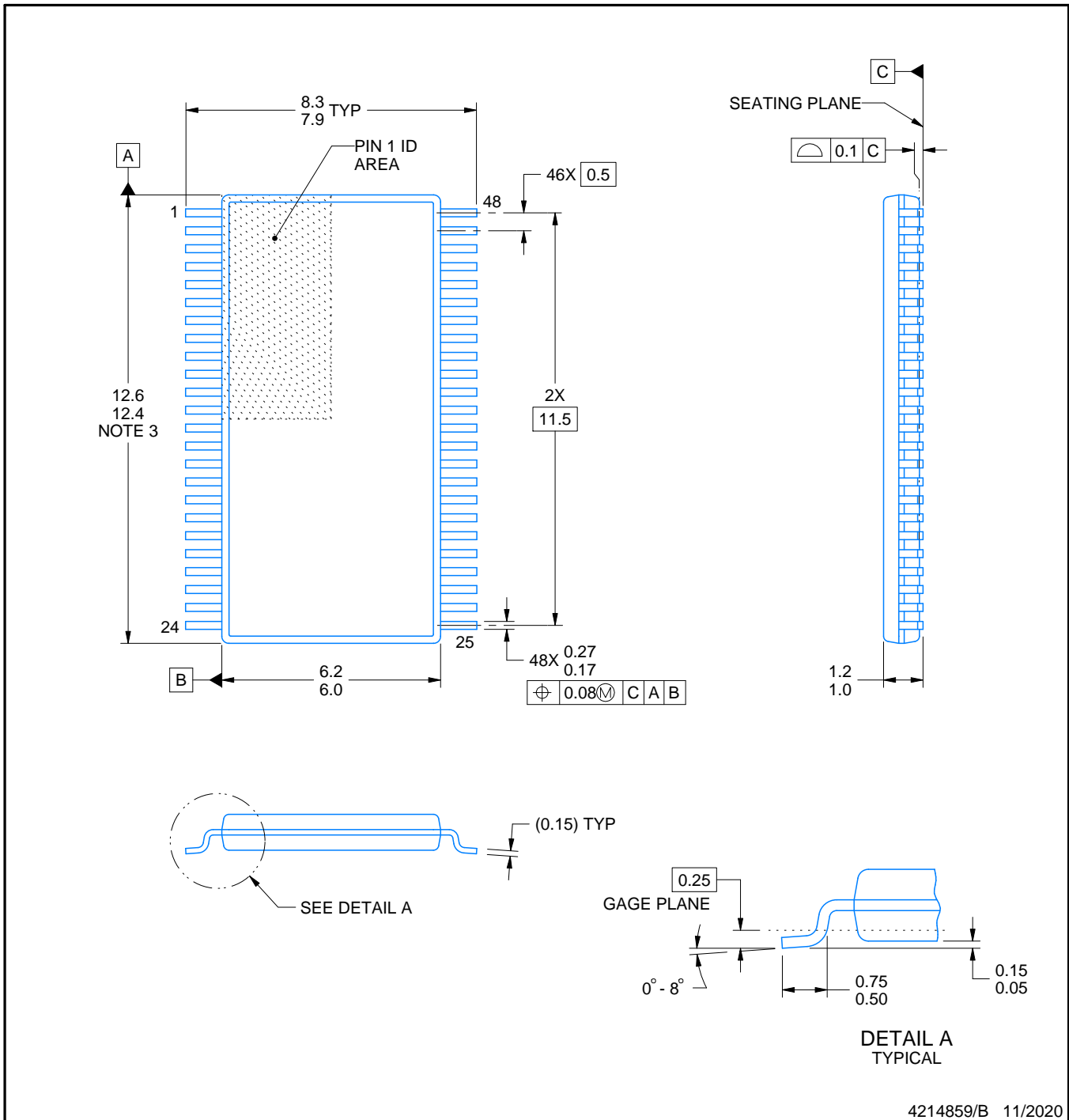
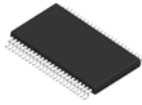

**NOTES:**

1. All linear dimensions are in millimeters. Any dimensions in parenthesis are for reference only. Dimensioning and tolerancing per ASME Y14.5M.
2. This drawing is subject to change without notice.
3. This dimension does not include mold flash, protrusions, or gate burrs. Mold flash, protrusions, or gate burrs shall not exceed 0.15 mm per side.
4. Reference JEDEC registration MO-153.

# EXAMPLE BOARD LAYOUT

DGG0048A

TSSOP - 1.2 mm max height

SMALL OUTLINE PACKAGE

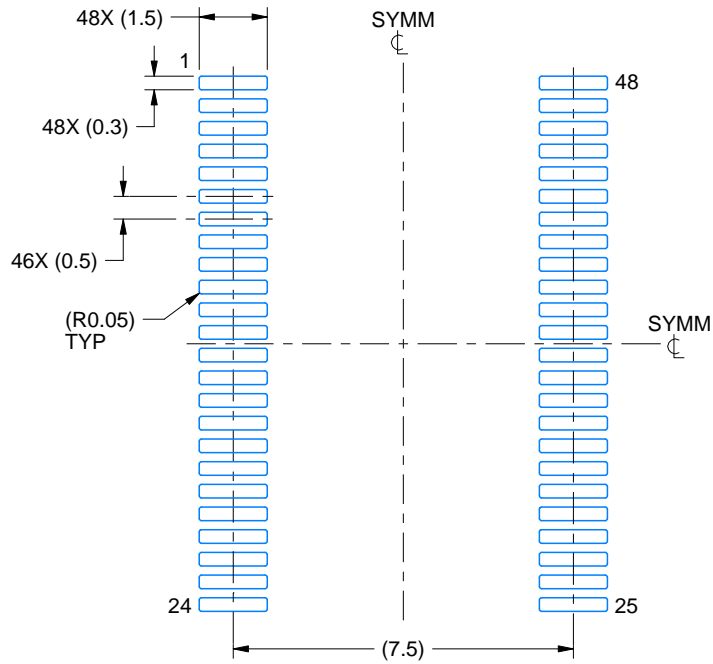

LAND PATTERN EXAMPLE  
SCALE:6X

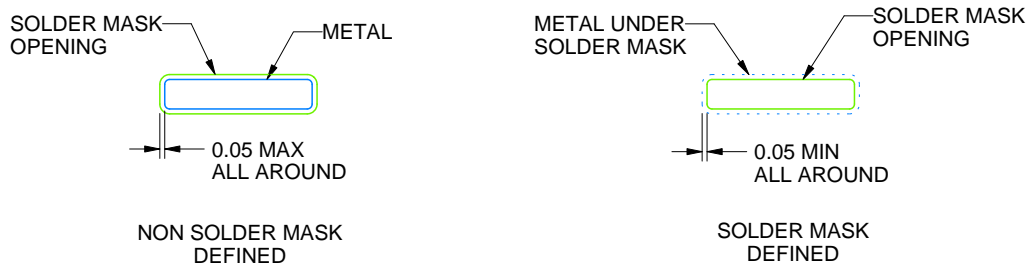

SOLDER MASK DETAILS

4214859/B 11/2020

NOTES: (continued)

5. Publication IPC-7351 may have alternate designs.
6. Solder mask tolerances between and around signal pads can vary based on board fabrication site.

# EXAMPLE STENCIL DESIGN

DGG0048A

TSSOP - 1.2 mm max height

SMALL OUTLINE PACKAGE

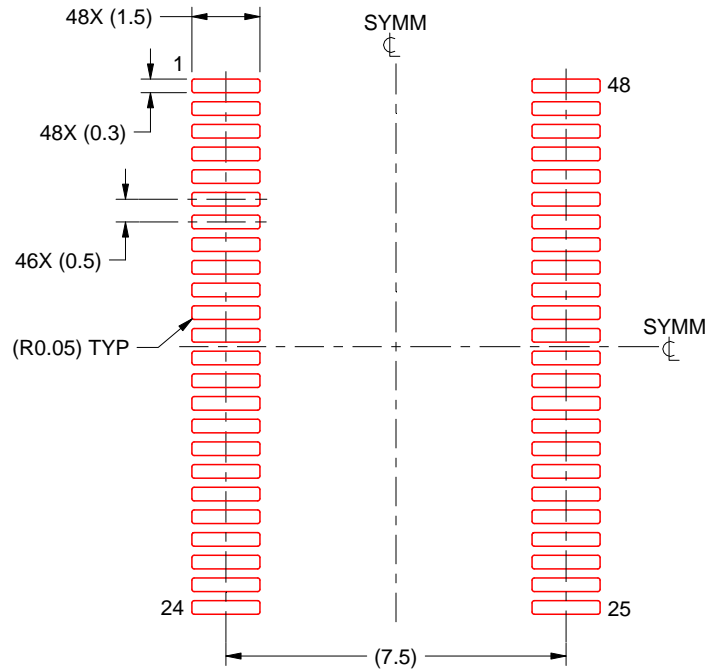

SOLDER PASTE EXAMPLE  
BASED ON 0.125 mm THICK STENCIL  
SCALE:6X

4214859/B 11/2020

NOTES: (continued)

7. Laser cutting apertures with trapezoidal walls and rounded corners may offer better paste release. IPC-7525 may have alternate design recommendations.
8. Board assembly site may have different recommendations for stencil design.

DGG (R-PDSO-G\*\*)

PLASTIC SMALL-OUTLINE PACKAGE

48 PINS SHOWN



- NOTES: A. All linear dimensions are in millimeters.  
 B. This drawing is subject to change without notice.  
 C. Body dimensions do not include mold protrusion not to exceed 0,15.  
 D. Falls within JEDEC MO-153

## IMPORTANT NOTICE AND DISCLAIMER

TI PROVIDES TECHNICAL AND RELIABILITY DATA (INCLUDING DATA SHEETS), DESIGN RESOURCES (INCLUDING REFERENCE DESIGNS), APPLICATION OR OTHER DESIGN ADVICE, WEB TOOLS, SAFETY INFORMATION, AND OTHER RESOURCES "AS IS" AND WITH ALL FAULTS, AND DISCLAIMS ALL WARRANTIES, EXPRESS AND IMPLIED, INCLUDING WITHOUT LIMITATION ANY IMPLIED WARRANTIES OF MERCHANTABILITY, FITNESS FOR A PARTICULAR PURPOSE OR NON-INFRINGEMENT OF THIRD PARTY INTELLECTUAL PROPERTY RIGHTS.

These resources are intended for skilled developers designing with TI products. You are solely responsible for (1) selecting the appropriate TI products for your application, (2) designing, validating and testing your application, and (3) ensuring your application meets applicable standards, and any other safety, security, regulatory or other requirements.

These resources are subject to change without notice. TI grants you permission to use these resources only for development of an application that uses the TI products described in the resource. Other reproduction and display of these resources is prohibited. No license is granted to any other TI intellectual property right or to any third party intellectual property right. TI disclaims responsibility for, and you will fully indemnify TI and its representatives against, any claims, damages, costs, losses, and liabilities arising out of your use of these resources.

TI's products are provided subject to [TI's Terms of Sale](#) or other applicable terms available either on [ti.com](http://ti.com) or provided in conjunction with such TI products. TI's provision of these resources does not expand or otherwise alter TI's applicable warranties or warranty disclaimers for TI products.

TI objects to and rejects any additional or different terms you may have proposed.

Mailing Address: Texas Instruments, Post Office Box 655303, Dallas, Texas 75265  
Copyright © 2022, Texas Instruments Incorporated