

## CLASS-G DIRECTPATH™ STEREO HEADPHONE AMPLIFIER

Check for Samples: [TPA6141A2](#)

### FEATURES

- **TI Class-G Technology Significantly Prolongs Battery Life and Music Playback Time**
  - **0.6 mA / Ch Quiescent Current**
  - **50% to 80% Lower Quiescent Current Than Ground-Referenced Class-AB Headphone Amplifiers**
- **DirectPath™ Technology Eliminates Large Output DC-Blocking Capacitors**
  - **Outputs Biased at 0 V**
  - **Improves Low Frequency Audio Fidelity**
- **Active Click and Pop Suppression**
- **Fully Differential Inputs Reduce System Noise**
  - **Also Configurable as Single-Ended Inputs**
- **SGND Pin Eliminates Ground Loop Noise**
- **Wide Power Supply Range: 2.5 V to 5.5 V**
- **100 dB Power Supply Noise Rejection**
- **Built-in Input Low Pass Filter**
- **Gain Settings: 0 dB and 6dB**
- **Short-Circuit Current Limiter**
- **Thermal-Overload Protection**
- **±8 kV HBM ESD Protected Outputs**
- **0,4 mm Pitch, 1,6 mm × 1,6 mm 16-Bump WCSP (YFF) Package**

### APPLICATIONS

- **Cellular Phones / Music Phones**
- **Smart Phones**
- **Portable Media / MP3 Players**
- **Portable CD / DVD Players**

### DESCRIPTION

The TPA6141A2 (also known as TPA6141) is a Class-G DirectPath™ stereo headphone amplifier with selectable gain. Class-G technology maximizes battery life by adjusting the voltage supplies of the headphone amplifier based on the audio signal level. At low level audio signals, the internal supply voltage is reduced to minimize power dissipation. DirectPath™ technology eliminates external DC-blocking capacitors.

The device features fully differential inputs with an integrated low pass filter to reduce system noise pickup between the audio source and the headphone amplifier and to reduce DAC out-of-band noise. The high power supply noise rejection performance and differential architecture provides increased RF noise immunity. For single-ended input signals, connect INL+ and INR+ to ground.

The device operates from a 2.5 V to 5.5 V supply voltage. Class-G operation keeps total supply current below 5.0 mA while delivering 500 μW per channel into 32 Ω. Shutdown mode reduces the supply current to less than 3 μA and is activated through the EN pin.

The device has built-in pop suppression circuitry to completely eliminate disturbing pop noise during turn-on and turn-off. The amplifier outputs have short-circuit and thermal-overload protection along with ±8 kV HBM ESD protection, simplifying end equipment compliance to the IEC 61000-4-2 ESD standard.

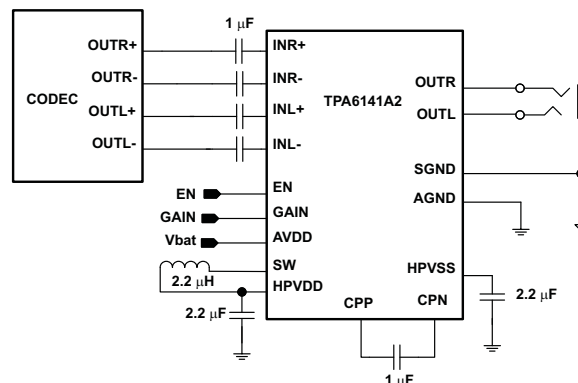

Please be aware that an important notice concerning availability, standard warranty, and use in critical applications of Texas Instruments semiconductor products and disclaimers thereto appears at the end of this data sheet.

Class-G DirectPath, DirectPath are trademarks of Texas Instruments.



This integrated circuit can be damaged by ESD. Texas Instruments recommends that all integrated circuits be handled with appropriate precautions. Failure to observe proper handling and installation procedures can cause damage.

ESD damage can range from subtle performance degradation to complete device failure. Precision integrated circuits may be more susceptible to damage because very small parametric changes could cause the device not to meet its published specifications.

**FUNCTIONAL BLOCK DIAGRAM**

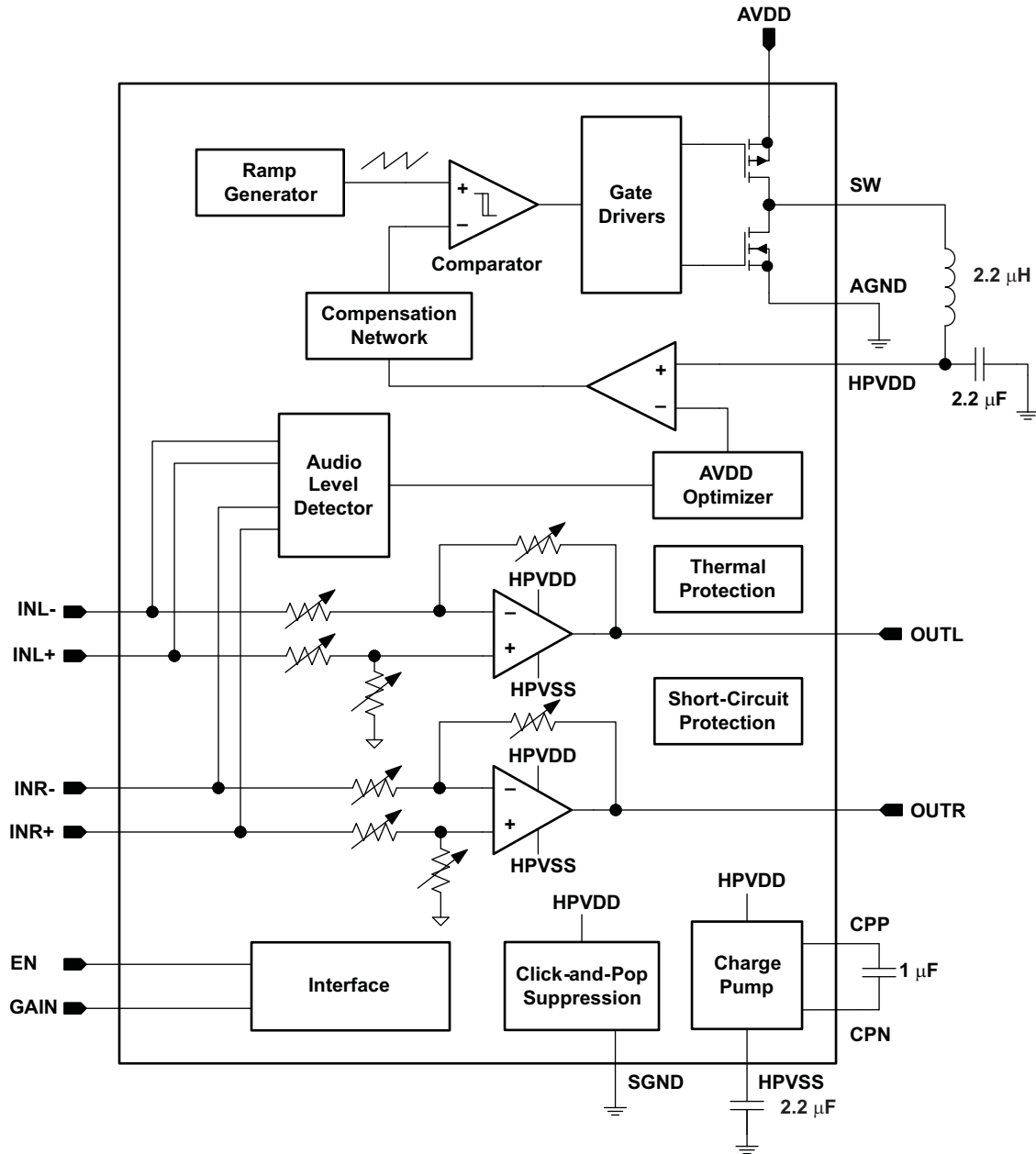

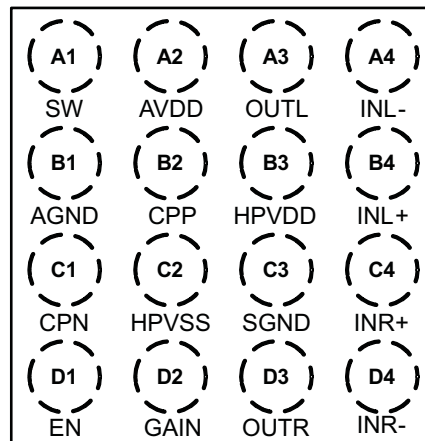
**DEVICE PINOUT**
**WCSP PACKAGE  
(TOP VIEW)**

**TERMINAL FUNCTIONS**

TERMINAL		INPUT / OUTPUT / POWER (I/O/P)	DESCRIPTION
NAME	BALL WCSP		
INL-	A4	I	Inverting left input for differential signals. Connect to left input signal through 1 $\mu$ F capacitor for single-ended input applications.
INL+	B4	I	Non-inverting left input for differential signals. Connect to ground through 1 $\mu$ F capacitor for single-ended input applications.
INR+	C4	I	Non-inverting right input for differential signals. Connect to ground through 1 $\mu$ F capacitor for single-ended input applications.
INR-	D4	I	Inverting right input for differential signals. Connect to right input signal through 1 $\mu$ F capacitor for single-ended input applications.
SGND	C3	I	Sense ground. Connect to shield terminal of headphone jack.
EN	D1	I	Amplifier enable. Connect to logic low to shutdown; connect to logic high to activate.
GAIN	D2	I	Amplifier gain select pin. Connect to logic low to select a gain of 0 dB; connect to logic high to select a gain of 6 dB.
OUTL	A3	O	Left headphone amplifier output. Connect to left terminal of headphone jack.
OUTR	D3	O	Right headphone amplifier output. Connect to right terminal of headphone jack.
CPP	B2	P	Charge pump positive flying cap. Connect to positive side of capacitor between CPP and CPN.
CPN	C1	P	Charge pump negative flying cap. Connect to negative side of capacitor between CPP and CPN.
SW	A1	P	Buck converter switching node.
AVDD	A2	P	Primary power supply for device.
HPVDD	B3	P	Power supply for headphone amplifier (DC/DC output node).
AGND	B1	P	Main Ground for headphone amplifiers, DC/DC converter, and charge pump.
HPVSS	C2	P	Charge pump output. Connect 2.2 $\mu$ F capacitor to GND.

**ORDERING INFORMATION**

T <sub>A</sub>	PACKAGED DEVICES <sup>(1)</sup>	PART NUMBER <sup>(2)</sup>	SYMBOL
-40°C to 85°C	16-ball, WCSP	TPA6141A2YFFR	ASBI
	16-ball, WCSP	TPA6141A2YFFT	ASBI

(1) For the most current package and ordering information, see the Package Option Addendum at the end of this document, or see the TI Web site at [www.ti.com](http://www.ti.com).

(2) YFF packages are only available taped and reeled. The suffix "R" indicates a reel of 3000, the suffix "T" indicates a reel of 250.

**ABSOLUTE MAXIMUM RATINGS<sup>(1)</sup>**over operating free-air temperature range,  $T_A = 25^\circ\text{C}$  (unless otherwise noted)

		VALUE / UNIT
	Supply voltage, AVDD	-0.3 V to 6.0 V
	Amplifier supply voltage, HPVDD	-0.3 V to 2.0 V
$V_I$	Input voltage (INR+, INR-, INL+, INL-)	-0.3 V to $HPV_{DD} + 0.3$ V
	Control input voltage (EN, GAIN)	-0.3 V to AVDD
	Output continuous total power dissipation	See Dissipation Rating Table
$T_A$	Operating free-air temperature range	-40°C to 85°C
$T_J$	Operating junction temperature range	-40°C to 150°C
$T_{stg}$	Storage temperature range	-65°C to 85°C
$R_L$	Minimum load resistance	12 $\Omega$
ESD Protection – HBM	OUTL, OUTR, SGND	8 kV
	All other pins	2 kV

- (1) Stresses beyond those listed under *absolute maximum ratings* may cause permanent damage to the device. These are stress ratings only, and functional operation of the device at these or any other conditions beyond those indicated under *recommended operating conditions* is not implied. Exposure to absolute-maximum-rated conditions for extended periods may affect device reliability.

**DISSIPATION RATINGS TABLE<sup>(1) (2)</sup>**

PACKAGE	$T_A < 25^\circ\text{C}$ POWER RATING	OPERATING FACTOR ABOVE $T_A = 25^\circ\text{C}$	$T_A = 70^\circ\text{C}$ POWER RATING	$T_A = 85^\circ\text{C}$ POWER RATING
YFF (WCSP)	1.25 W	10 mW/°C	800 mW	650 mW

- (1) Derating factor measured with JEDEC High K board: 1S0P – One signal layer and zero plane layers.  
 (2) See JEDEC Standard 51-3 for Low-K board, JEDEC Standard 51-7 for High-K board, and JEDEC Standard 51-12 for using package thermal information. See JEDEC document page for downloadable copies: <http://www.jedec.org/download/default.cfm>.

**RECOMMENDED OPERATING CONDITIONS**

		MIN	MAX	UNIT
$V_{DD}$	Supply voltage, AVDD	2.5	5.5	V
$V_{IH}$	High-level input voltage	EN, GAIN	1.3	V
$V_{IL}$	Low-level input voltage	EN, GAIN	0.6	V
	Voltage applied to Output; OUTR, OUTL (when EN = logic low)	-0.3	3.6	
$T_A$	Operating free-air temperature	-40	+85	°C

## ELECTRICAL CHARACTERISTICS

 $T_A = 25^\circ\text{C}$  (unless otherwise noted)

PARAMETER		TEST CONDITIONS	MIN	TYP	MAX	UNIT
PSRR	Power supply rejection ratio	AVDD = 2.5 V to 5.5 V, inputs grounded, GAIN = 0 dB	90	105		dB
CMRR	Common mode rejection ratio	HPVDD = 1.3 V to 1.8 V, GAIN = 0 dB		68		dB
$ I_{IH} $	High-level input current	AVDD = 2.5 V to 5.5 V, $V_I = \text{AVDD}$			1	$\mu\text{A}$
$ I_{IL} $	Low-level input current	AVDD = 2.5 V to 5.5 V, $V_I = 0\text{ V}$			1	$\mu\text{A}$
$I_{SD}$	Shutdown current	EN = 0 V, AVDD = 2.5 V to 5.5 V		1	3	$\mu\text{A}$
$I_{DD}$	Total supply current	AVDD = 3.6 V HPVDD = 1.3 V, Amplifiers active, no load, no input signal		1.2	2.0	mA
		AVDD = 3.6 V, $P_{OUT} = 100\ \mu\text{W}$ into $32\ \Omega^{(1)}$ , $f_{AUD} = 1\ \text{kHz}$		2.5		
		AVDD = 3.6 V, $P_{OUT} = 500\ \mu\text{W}$ into $32\ \Omega^{(1)}$ , $f_{AUD} = 1\ \text{kHz}$		4.0		
		AVDD = 3.6 V, $P_{OUT} = 1\ \text{mW}$ into $32\ \Omega^{(1)}$ , $f_{AUD} = 1\ \text{kHz}$		6.8		

(1) Per channel output power assuming a 10 dB crest factor

## OPERATING CHARACTERISTICS

 $\text{AV}_{DD} = 3.6\ \text{V}$ ,  $T_A = 25^\circ\text{C}$ , GAIN = 0 dB,  $R_L = 32\ \Omega$  (unless otherwise noted)

PARAMETER		TEST CONDITIONS	MIN	TYP	MAX	UNIT
$P_O$	Output power <sup>(1)</sup> (Outputs in Phase)	AVDD = 2.7 V, THD = 1%, $f = 1\ \text{kHz}$		26		mW
		AVDD = 2.7 V, THD = 10%, $f = 1\ \text{kHz}$		32		
		AVDD = 2.7 V, THD = 1%, $f = 1\ \text{kHz}$ , $R_L = 16\ \Omega$		25		
THD+N	Total harmonic distortion plus noise <sup>(2)</sup>	$P_O = 10\ \text{mW}$ into $16\ \Omega$ , $f = 1\ \text{kHz}$		0.02%		
		$P_O = 20\ \text{mW}$ into $32\ \Omega$ , $f = 1\ \text{kHz}$		0.01%		
$k_{SVR}$	AC-Power supply rejection ratio	200 mVpp ripple, $f = 217\ \text{Hz}$	80	100		dB
		200 mVpp ripple, $f = 4\ \text{kHz}$		90		
$A_V$	Closed-loop voltage gain (OUT / IN-)	GAIN = logic low		0		dB
		GAIN = logic high		6		dB
$\Delta A_V$	Gain matching	Between left and right channels		1%		
$V_{OS}$	Output offset voltage	AVDD = 2.5 V to 5.5 V, inputs grounded	0.5	0	0.5	mV
$E_N$	Noise output voltage	A-weighted		5.3		$\mu\text{V}_{RMS}$
$f_{BUCK}$	Buck converter switching frequency	$P_O = 0.5\ \text{mW}$ , $f = 1\ \text{kHz}$		600		kHz
$f_{PUMP}$	Charge pump switching frequency	$P_O = 0.5\ \text{mW}$ , $f = 1\ \text{kHz}$		315		kHz
		$P_O = 15\ \text{mW}$ , $f = 1\ \text{kHz}$		1260		
	Start-up time from shutdown			5		ms
$R_{IN,SE}$	Single Ended Input impedance	Gain = 6 dB, per input node		13.2		k $\Omega$
$R_{IN,DF}$	Differential input impedance	Gain = 6 dB, per input node		26.4		k $\Omega$
SNR	Signal-to-noise ratio	$V_{OUT} = 1\ \text{V}_{RMS}$ , GAIN = 6 dB, no load		105		dB
	Thermal shutdown	Threshold		165		$^\circ\text{C}$
		Hysteresis		35		
$Z_{O,SD}$	Output impedance in shutdown	EN = logic low, DC value		8		k $\Omega$
	Input to Output attenuation in shutdown	EN = logic low, $f = 1\ \text{kHz}$ , $V_{OUT} = 1\ \text{V}_{RMS}$		90		dB
	Crosstalk	$P_O = 15\ \text{mW}$ , $f = 1\ \text{kHz}$		-80		dB
$V_{CM}$	Input common-mode voltage range		0		1.4	V

(1) Per channel output power

(2) A-weighted

**TYPICAL CHARACTERISTICS**

$T_A = 25^\circ\text{C}$ ,  $AV_{DD} (V_{DD}) = 3.6\text{ V}$ ,  $\text{GAIN} = 0\text{ dB}$ ,  $C_{HPVDD} = C_{HPVSS} = 2.2\ \mu\text{F}$ ,  $C_{INPUT} = C_{FLYING} = 1\ \mu\text{F}$ , Outputs out of phase

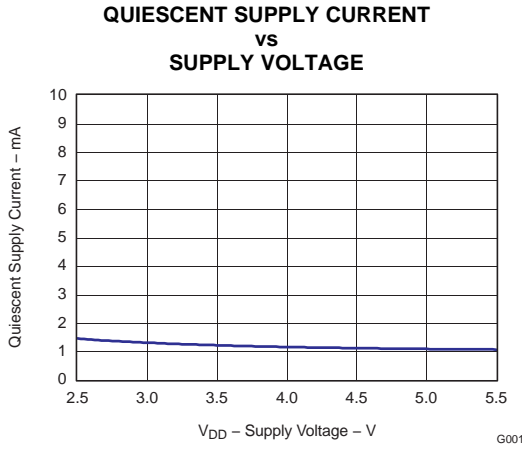

Figure 1.

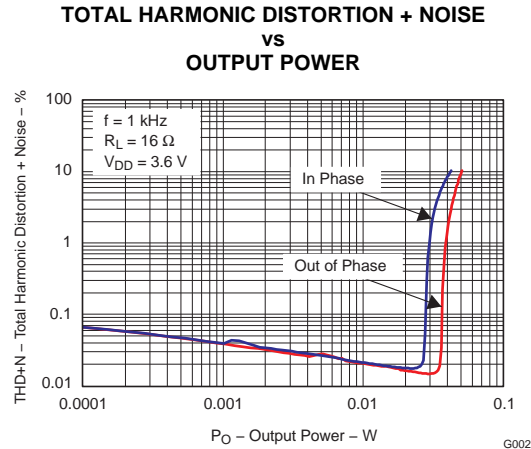

Figure 2.

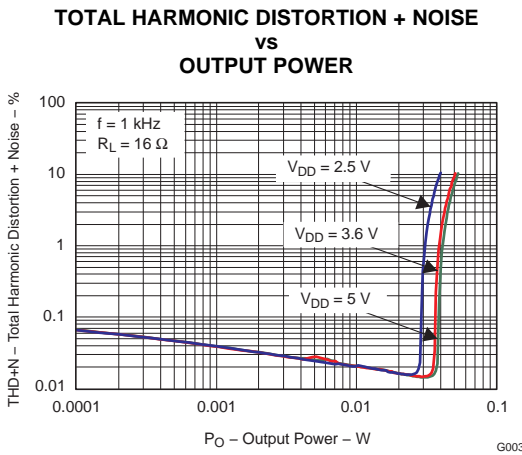

Figure 3.

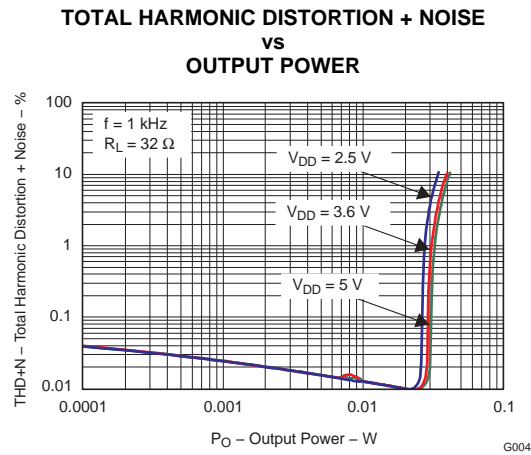

Figure 4.

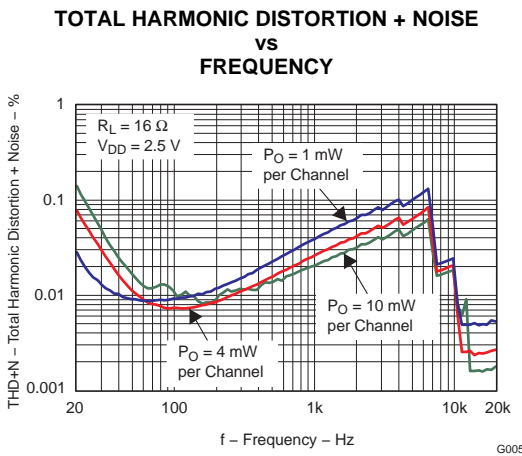

Figure 5.

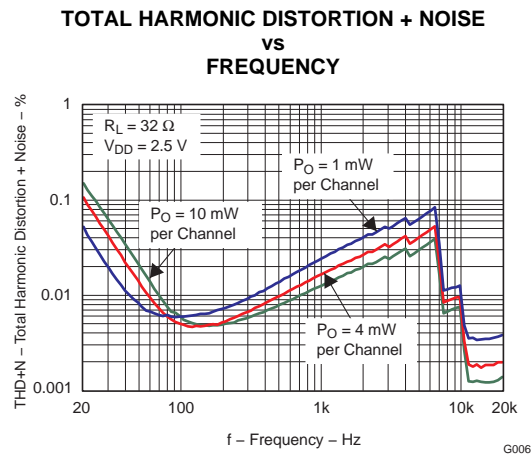

Figure 6.

**TYPICAL CHARACTERISTICS (continued)**

$T_A = 25^\circ\text{C}$ ,  $AV_{DD} (V_{DD}) = 3.6\text{ V}$ ,  $\text{GAIN} = 0\text{ dB}$ ,  $C_{HPVDD} = C_{HPVSS} = 2.2\ \mu\text{F}$ ,  $C_{INPUT} = C_{FLYING} = 1\ \mu\text{F}$ , Outputs out of phase

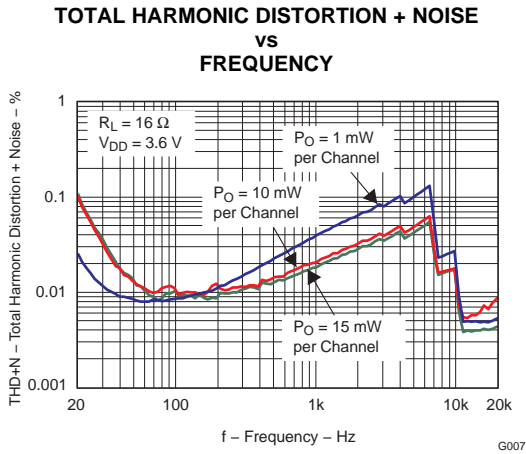

Figure 7.

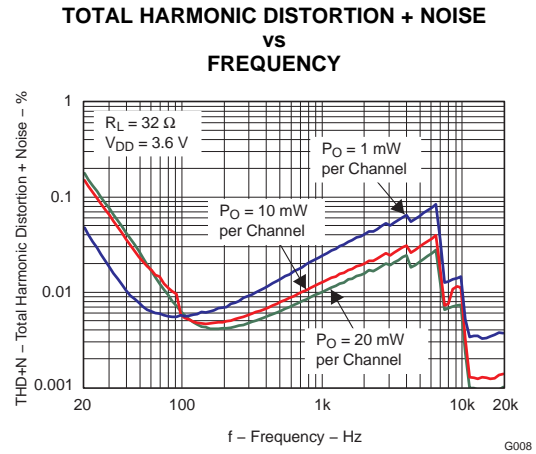

Figure 8.

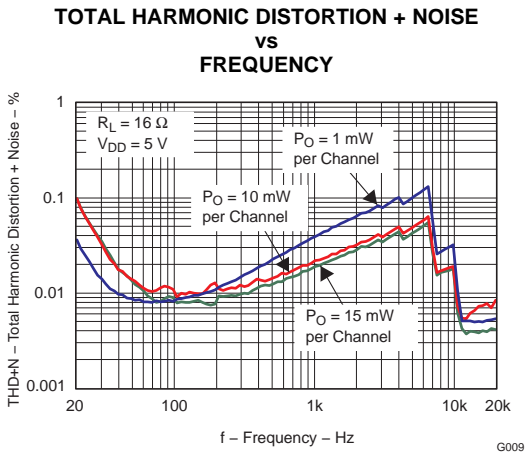

Figure 9.

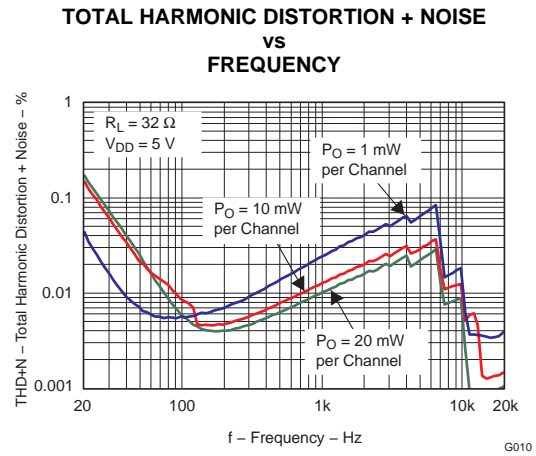

Figure 10.

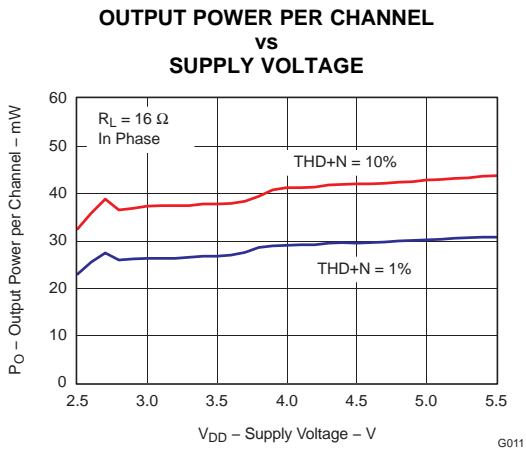

Figure 11.

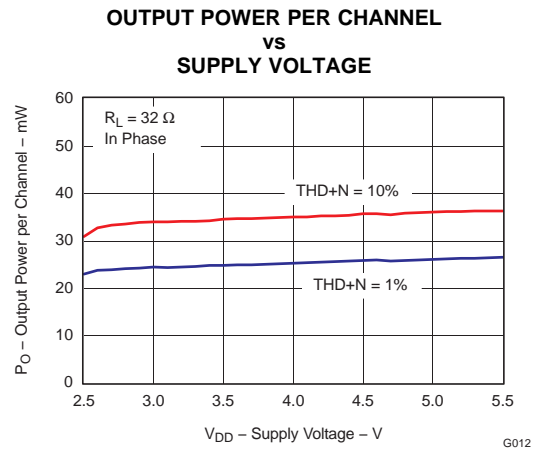

Figure 12.

**TYPICAL CHARACTERISTICS (continued)**

$T_A = 25^\circ\text{C}$ ,  $AV_{DD} (V_{DD}) = 3.6\text{ V}$ ,  $\text{GAIN} = 0\text{ dB}$ ,  $C_{HPVDD} = C_{HPVSS} = 2.2\ \mu\text{F}$ ,  $C_{INPUT} = C_{FLYING} = 1\ \mu\text{F}$ , Outputs out of phase

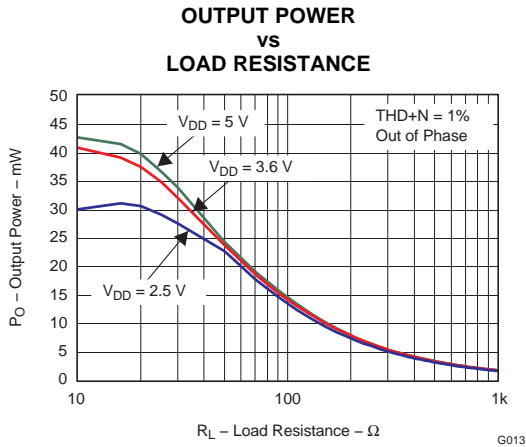

Figure 13.

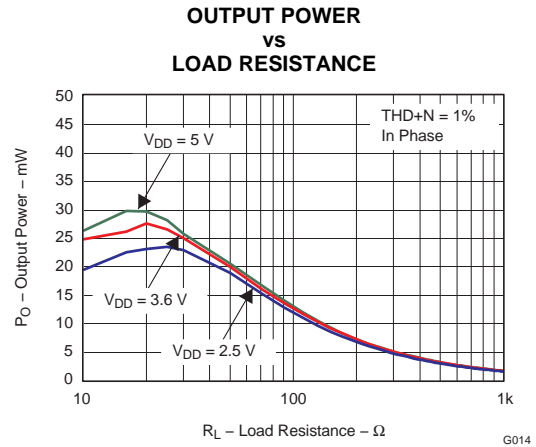

Figure 14.

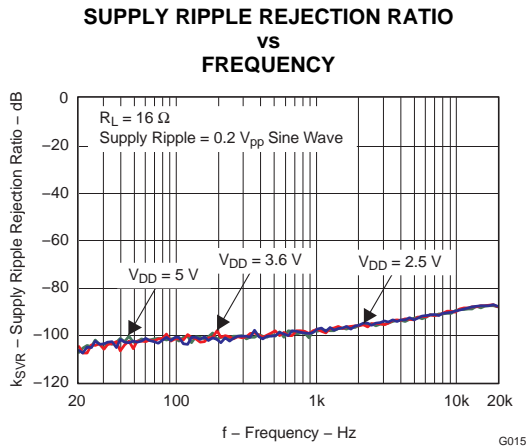

Figure 15.

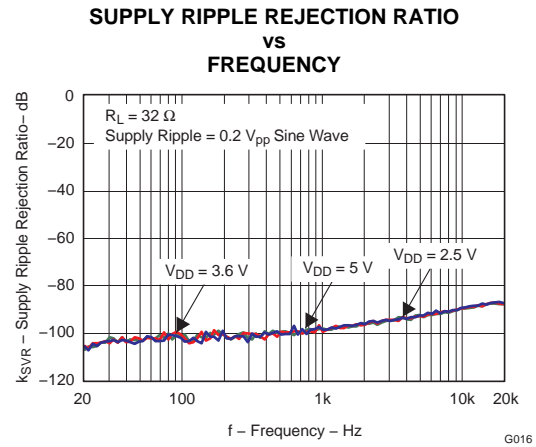

Figure 16.

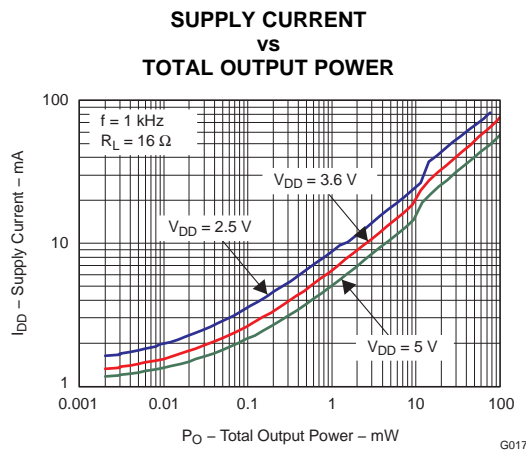

Figure 17.

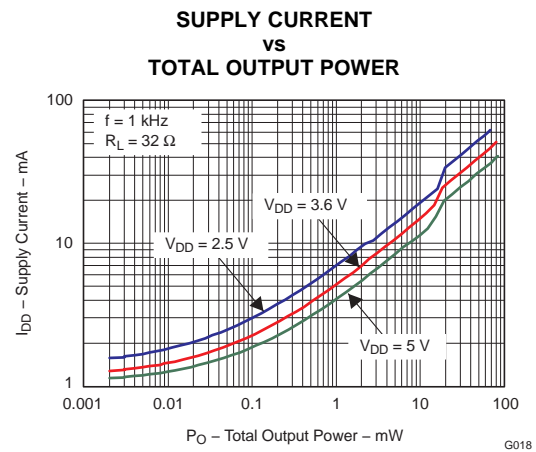

Figure 18.



**TYPICAL CHARACTERISTICS (continued)**

$T_A = 25^\circ\text{C}$ ,  $AV_{DD} (V_{DD}) = 3.6 \text{ V}$ ,  $\text{GAIN} = 0 \text{ dB}$ ,  $C_{HPVDD} = C_{HPVSS} = 2.2 \mu\text{F}$ ,  $C_{INPUT} = C_{FLYING} = 1 \mu\text{F}$ , Outputs out of phase

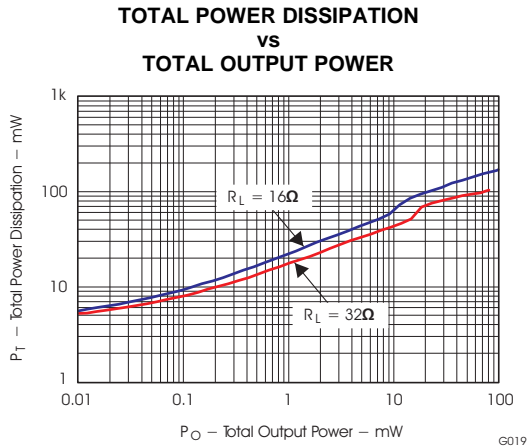

Figure 19.

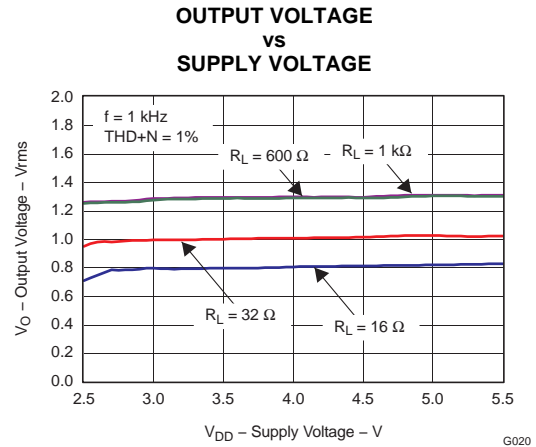

Figure 20.

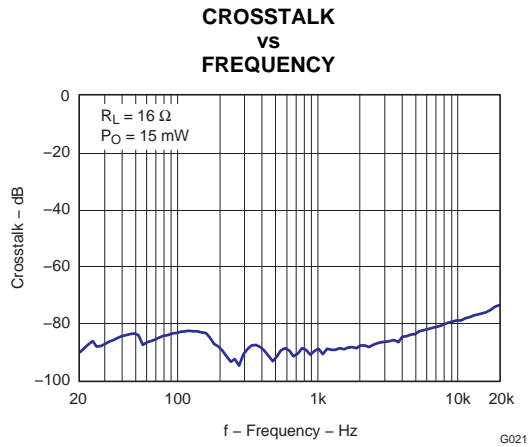

Figure 21.

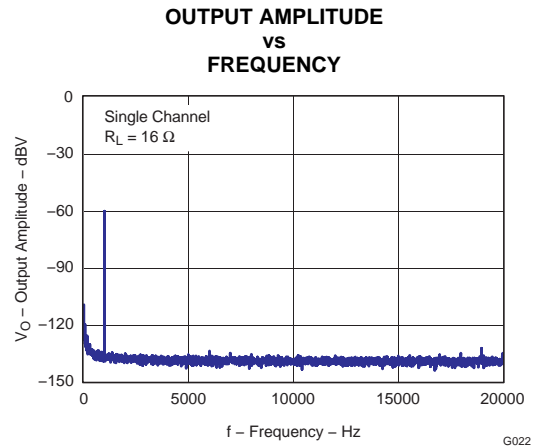

Figure 22.

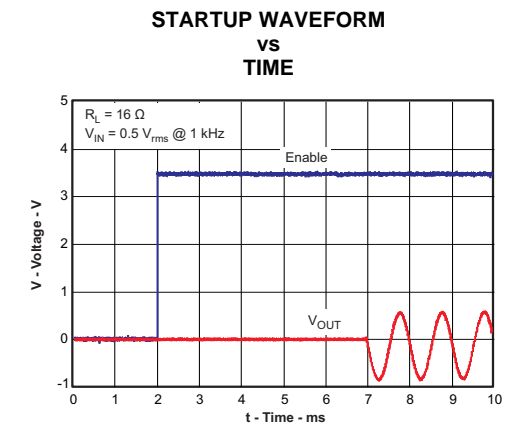

Figure 23.

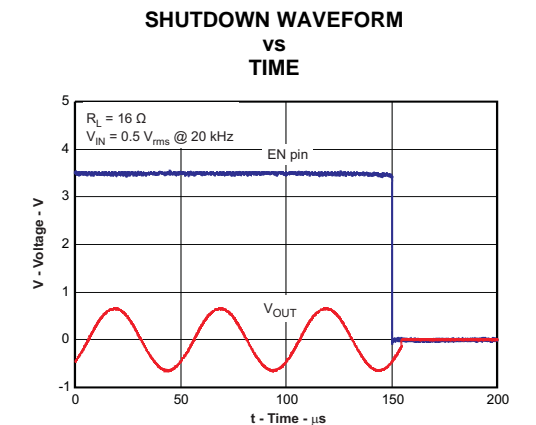

Figure 24.

APPLICATION INFORMATION

APPLICATION CIRCUIT

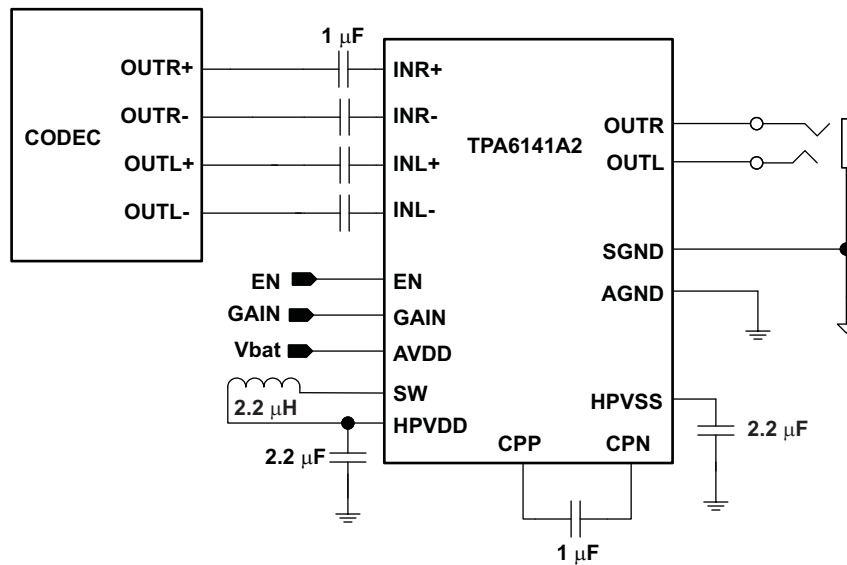

Figure 25. Typical Application Configuration with Differential Input Signals

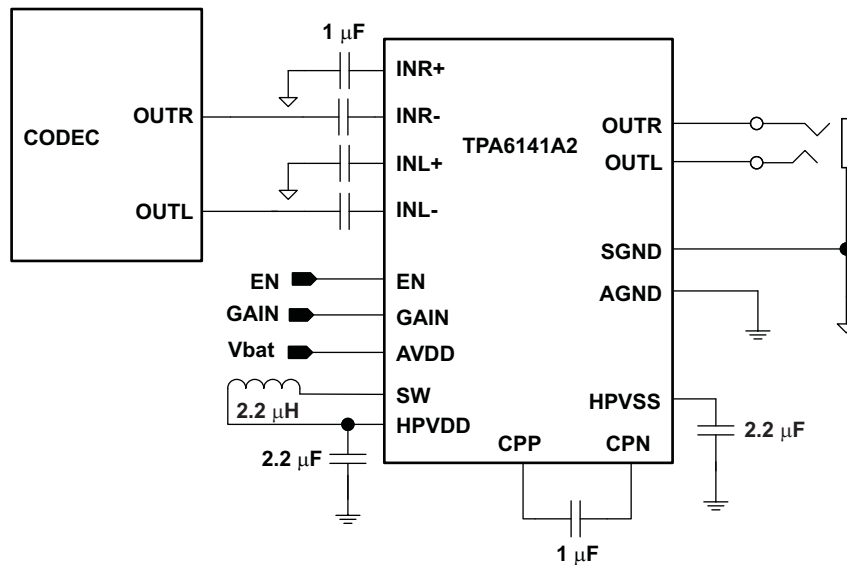

Figure 26. Typical Application Configuration with Single-Ended Input Signals

## CLASS-G HEADPHONE AMPLIFIER

Class-G amplifiers use adaptive supply rails. The TPA6141A2 includes a built-in step-down converter to create the headphone amplifier positive supply voltage, HPVDD. A charge pump inverts HPVDD and creates the amplifier negative supply voltage, HPVSS. This allows the headphone amplifier output to be centered at 0 V.

When audio signal amplitude is low, the step-down converter generates a low HPVDD voltage. This minimizes TPA6141A2 power consumption while playing low noise, high fidelity audio. If audio amplitude increases, either due to louder music or a transient peak, then the step-down converter generates a higher HPVDD voltage. The HPVDD rise rate is faster than the audio peak rise time. This prevents audio distortion or clipping. Audio quality and noise floor are not affected by HPVDD.

This adaptive HPVDD minimizes TPA6141A2 supply current while avoiding clipping and distortion. Because normal listening levels are below 200 mV<sub>RMS</sub>, HPVDD is most often at its lowest voltage. Thus, the TPA6141A2 has higher efficiency than traditional Class-AB headphone amplifiers.

The following equations compare a Class-AB amplifier to a Class-G amplifier. Both operate with identical battery voltage, load impedance, and output voltage swing. For this study case, we assume a normal listening level of 200 mV<sub>RMS</sub> with no DirectPath™ in order to simplify the calculations.

- P<sub>SUP</sub>: Supplied power
- V<sub>SUP</sub>: Supply voltage
- I<sub>SUP</sub>: Supply current
- V<sub>REG</sub>: DC/DC converter output voltage
- P<sub>REG</sub>: DC/DC converter output power
- V<sub>LOAD</sub>: Voltage across the load
- R<sub>LOAD</sub>: Load impedance
- P<sub>LOAD</sub>: Power dissipated at the load
- I<sub>LOAD</sub>: Current supplied to the load

Given an amplifier driving 200 mV<sub>RMS</sub> into a 32 Ω load, the output current to the load is:

$$I_{LOAD} = \frac{V_{LOAD}}{R_{LOAD}} = \frac{200 \text{ mV}_{RMS}}{32 \Omega} = 6.25 \text{ mA} \quad (1)$$

Assuming a quiescent current of 1 mA (I<sub>DDQ</sub>) the total current supplied to the amplifier is:

$$I_{SUP} = I_{LOAD} + I_{DDQ} = 7.25 \text{ mA} \quad (2)$$

The total power supplied to a Class-AB amplifier is then calculated as:

$$P_{SUP} = V_{SUP} \times I_{SUP} = 4.2 \text{ V} \times 7.25 \text{ mA} = 30.45 \text{ mW} \quad (3)$$

For a Class-G amplifier where the voltage rails are generated by a switching DC/DC converter, the supplied power will depend on the DC/DC converter output voltage and efficiency. Assuming the DC/DC converter output voltage is 1.3 V:

$$P_{REG} = V_{REG} \times I_{SUP} = 1.3 \text{ V} \times 7.25 \text{ mA} = 9.425 \text{ mW} \quad (4)$$

The total supplied power will be the DC/DC converter output power divided by the efficiency of the DC/DC converter. Assuming 90% step-down efficiency, total power supplied to the Class-G amplifier is:

$$P_{SUP} = \frac{P_{REG}}{90\%} = 11.09 \text{ mW} \quad (5)$$

Class-G headphone amplifiers achieve much higher efficiency than equivalent Class-AB amplifiers.

### INDUCTOR SELECTION

The TPA6141A2 requires one inductor for its DC/DC converter. The following table lists recommended inductors. Inductors not shown on this table can be used if they have similar performance characteristics.

When selecting an inductor observe the following rules:

- Lower DCR increases DC/DC converter efficiency.
- The minimum working inductance should never be below 1  $\mu$ H.
- Include temperature and aging derating factors into the inductor value calculations.

MANUFACTURER	PART NUMBER
TOKO	MDT2012-CH2R2A
Murata	LQM21PN2R2MC0D
	LQH2MCN2R2M02L
Taiyo Yuden	BRL2012T2R2M
	BRC1608T2R2M

### GAIN CONTROL

The TPA6141A2 has two gain settings which are controlled with the GAIN pin. The following table gives an overview of the gain function.

GAIN VOLTAGE	AMPLIFIER GAIN
$\leq 0.6$ V	0 dB
$\geq 1.3$ V	6 dB

### GROUND SENSE FUNCTION

The ground sense pin, SGND, reduces ground-loop noise when the audio output jack is connected to a different ground reference than codec and amplifier ground. Always connect the SGND pin to the headphone jack. This reduces output offset voltage and eliminates turn-on pop. Figure 27 shows how to connect SGND when an FM radio antenna function is implemented on the headphone wire. The nH coil and capacitor separate the RF signal from the audio GND signal. In this case, SGND is used to eliminate the offset voltage that is generated from the audio signal current and the RF coil low-frequency impedance.

The voltage difference between SGND and AGND cannot be greater than  $\pm 300$  mV. The amplifier performance degrades if the voltage difference between SGND and AGND is greater than  $\pm 300$  mV.

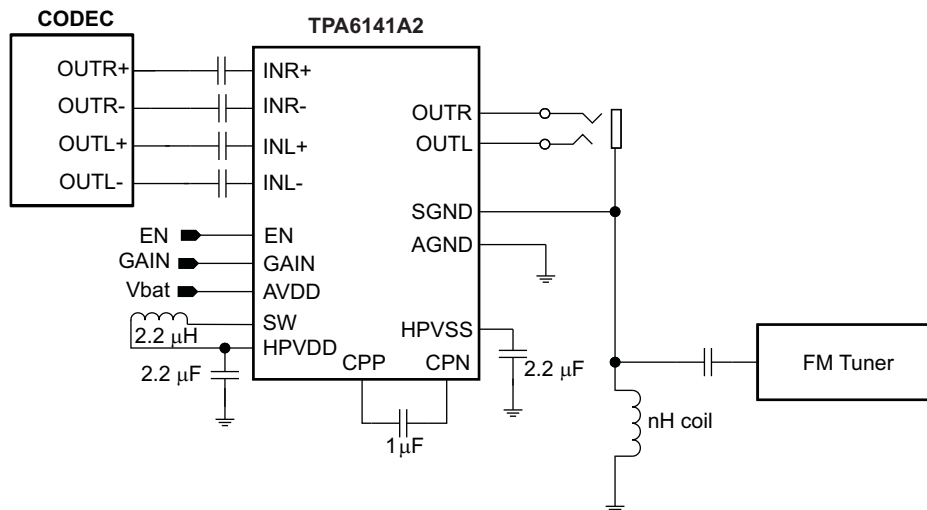

Figure 27. Sense Ground

## HEADPHONE AMPLIFIERS

Single-supply headphone amplifiers typically require dc-blocking capacitors to remove dc bias from their output voltage. The top drawing in [Figure 28](#) illustrates this connection. If dc bias is not removed, large dc current will flow through the headphones which wastes power, clips the output signal, and potentially damages the headphones.

These dc-blocking capacitors are often large in value and size. Headphone speakers have a typical resistance between 16  $\Omega$  and 32  $\Omega$ . This combination creates a high-pass filter with a cutoff frequency as shown in [Equation 6](#), where  $R_L$  is the load impedance,  $C_O$  is the dc-block capacitor, and  $f_C$  is the cutoff frequency.

$$f_C = \frac{1}{2\pi R_L C_O} \quad (6)$$

For a given high-pass cutoff frequency and load impedance, the required dc-blocking capacitor is found as:

$$C_O = \frac{1}{2\pi f_C R_L} \quad (7)$$

Reducing  $f_C$  improves low frequency fidelity and requires a larger dc-blocking capacitor. To achieve a 20 Hz cutoff with 16  $\Omega$  headphones,  $C_O$  must be at least 500  $\mu\text{F}$ . Large capacitor values require large packages, consuming PCB area, increasing height, and increasing cost of assembly. During start-up or shutdown the dc-blocking capacitor has to be charged or discharged. This causes an audible pop on start-up and power-down. Large dc-blocking capacitors also reduce audio output signal fidelity.

Two different headphone amplifier architectures are available to eliminate the need for dc-blocking capacitors. The capless amplifier architecture provides a reference voltage to the headphone connector shield pin as shown in the middle drawing of [Figure 28](#). The audio output signals are centered around this reference voltage, which is typically half of the supply voltage to allow symmetrical output voltage swing.

When using a capless amplifier do not connect the headphone jack shield to any ground reference or large currents will result. This makes capless amplifiers ineffective for plugging non-headphone accessories into the headphone connector. capless amplifiers are useful only with floating GND headphones.

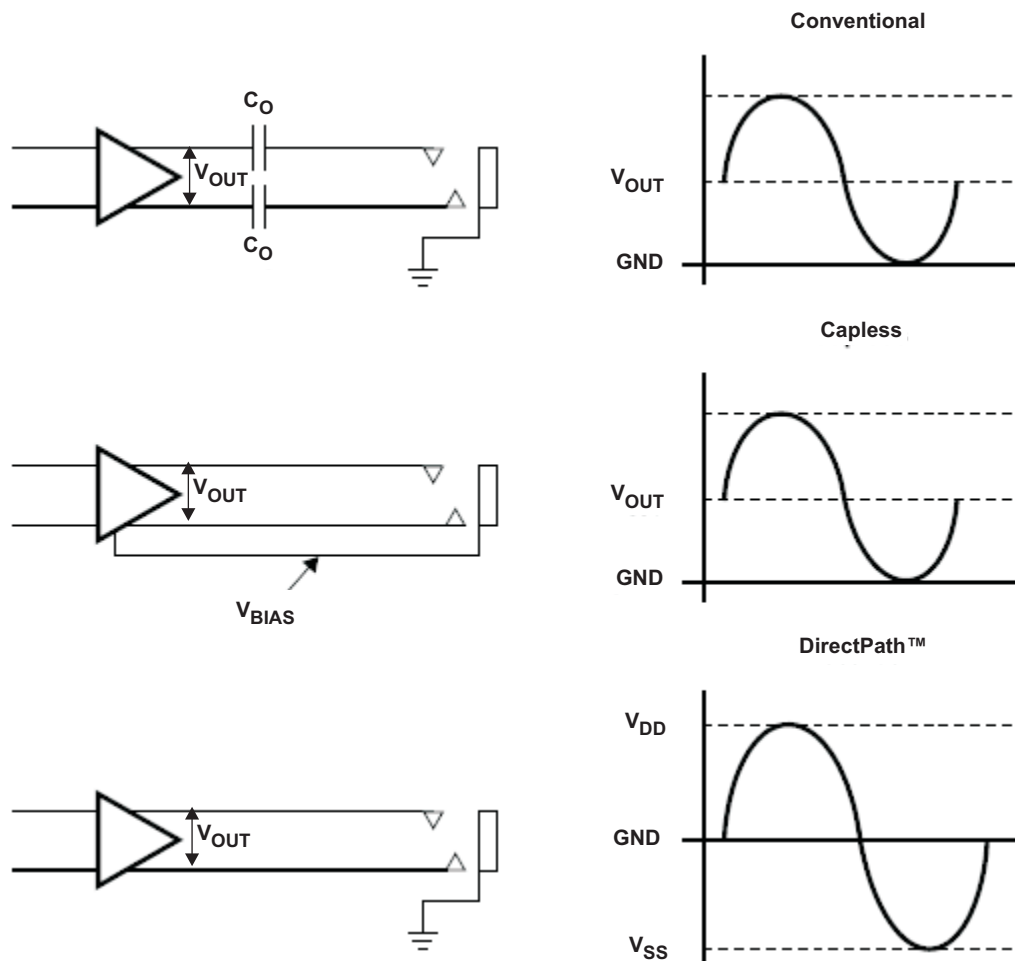

**Figure 28. Amplifier Applications**

The DirectPath™ amplifier architecture operates from a single supply voltage and uses an internal charge pump to generate a negative supply rail for the headphone amplifier. The output voltages are centered around 0 V and are capable of positive and negative voltage swings as shown in the bottom drawing of Figure 28. DirectPath amplifiers require no output dc-blocking capacitors. The headphone connector shield pin connects to ground and will interface with headphones and non-headphone accessories. The TPA6141A2 is a DirectPath amplifier.

### ELIMINATING TURN-ON POP AND POWER SUPPLY SEQUENCING

The TPA6141A2 has excellent noise and turn-on / turn-off pop performance. It uses an integrated click-and-pop suppression circuit to allow fast start-up and shutdown without generating any voltage transients at the output pins. Typical start-up time from shutdown is 5 ms.

DirectPath technology keeps the output dc voltage at 0 V even when the amplifier is powered up. The DirectPath technology together with the active pop-and-click suppression circuit eliminates audible transients during start up and shutdown.

Use input coupling capacitors to ensure inaudible turn-on pop. Activate the TPA6141A2 after all audio sources have been activated and their output voltages have settled. On power-down, deactivate the TPA6141A2 before deactivating the audio input source. The EN pin controls device shutdown: Set to EN to  $V_{IL}$  or lower to deactivate the TPA6141A2; set to  $V_{IH}$  or higher to activate. Refer to the Recommended Operating Conditions table for the  $V_{IL}$  and  $V_{IH}$  values.

## RF AND POWER SUPPLY NOISE IMMUNITY

The TPA6141A2 employs a new differential amplifier architecture to achieve high power supply noise rejection and RF noise rejection. RF and power supply noise are common in modern electronics. Although RF frequencies are much higher than the 20 kHz audio band, signal modulation often falls in-band. This, in turn, modulates the supply voltage, allowing a coupling path into the audio amplifier. A common example is the 217 Hz GSM frame-rate buzz often heard from an active speaker when a cell phone is placed nearby during a phone call.

The TPA6141A2 has excellent rejection of power supply and RF noise, preventing audio signal degradation.

## INPUT COUPLING CAPACITORS

Input coupling capacitors block any dc bias from the audio source and ensure maximum dynamic range. Input coupling capacitors also minimize TPA6141A2 turn-on pop to an inaudible level.

The input capacitors are in series with TPA6141A2 internal input resistors, creating a high-pass filter. [Equation 8](#) calculates the high-pass filter corner frequency. The input impedance,  $R_{IN}$ , is dependent on device gain. Larger input capacitors decrease the corner frequency. See the Operating Characteristics table for input impedance values.

$$f_C = \frac{1}{2\pi R_{IN} C_{IN}} \quad (8)$$

For a given high-pass cutoff frequency, the minimum input coupling capacitor is found as:

$$C_{IN} = \frac{1}{2\pi f_C R_{IN}} \quad (9)$$

Example: Design for a 20 Hz corner frequency with a TPA6141A2 gain of +6 dB. The Operating Characteristics table gives  $R_{IN}$  as 13.2 k $\Omega$ . [Equation 9](#) shows the input coupling capacitors must be at least 0.6  $\mu$ F to achieve a 20 Hz high-pass corner frequency. Choose a 0.68  $\mu$ F standard value capacitor for each TPA6141A2 input (X5R material or better is required for best performance).

Input capacitors can be removed provided the TPA6141A2 inputs are driven differentially with less than  $\pm 1 V_{RMS}$  and the common-mode voltage is within the input common-mode range of the amplifier. Without input capacitors turn-on pop performance may be degraded and should be evaluated in the system.

## CHARGE PUMP FLYING CAPACITOR AND HPVSS CAPACITOR

The TPA6141A2 uses a built-in charge pump to generate a negative voltage supply for the headphone amplifiers. The charge pump flying capacitor connects between CPP and CPN. It transfers charge to generate the negative supply voltage. The HPVSS capacitor must be at least equal in value to the flying capacitor to allow maximum charge transfer. Use low equivalent-series-resistance (ESR) ceramic capacitors (X5R material or better is required for best performance) to maximize charge pump efficiency. Typical values are 1  $\mu$ F to 2.2  $\mu$ F for the HPVSS and flying capacitors. Although values down to 0.47  $\mu$ F can be used, total harmonic distortion (THD) will increase.

## OPERATION WITH DACs AND CODECs AND INPUT RF NOISE REJECTION

When using amplifiers with CODECs and DACs, sometimes there is an increase in the output noise floor from the audio amplifier. This occurs when the output out-of-band noise of the CODEC/DAC folds back into the audio frequency due to the limited gain bandwidth product of the audio amplifier. Single-ended RF noise can also fold back into the audio band thus degrading the audio signal even further.

The TPA6141A2 has a built-in low-pass filter to reduce CODEC/DAC out-of-band noise and RF noise, that could fold back into the audio frequency.

## POWER SUPPLY AND HPVDD DECOUPLING CAPACITORS AND CONNECTIONS

The TPA6141A2 DirectPath headphone amplifier requires adequate power supply decoupling to ensure that output noise and total harmonic distortion (THD) remain low. Use good low equivalent-series-resistance (ESR) ceramic capacitors (X5R material or better is required for best performance). Place a 2.2  $\mu\text{F}$  capacitor within 5 mm of the AVDD pin. Reducing the distance between the decoupling capacitor and AVDD minimizes parasitic inductance and resistance, improving TPA6141A2 supply rejection performance. Use 0402 or smaller size capacitors if possible. Ensure that the ground connection of each of the capacitors has a minimum length return path to the device. Failure to properly decouple the TPA6141A2 may degrade audio or EMC performance.

For additional supply rejection, connect an additional 10  $\mu\text{F}$  or higher value capacitor between AVDD and ground. This will help filter lower frequency power supply noise. The high power supply rejection ratio (PSRR) of the TPA6141A2 makes the 10  $\mu\text{F}$  capacitor unnecessary in most applications.

Connect a 2.2  $\mu\text{F}$  capacitor between HPVDD and ground. This ensures the amplifier internal bias supply remains stable and maximizes headphone amplifier performance.

**DO NOT connect HPVDD directly to AVDD or an external supply voltage. The voltage at HPVDD is generated internally. Connecting HPVDD to an external voltage can damage the device.**

## LAYOUT RECOMMENDATIONS

### GND CONNECTIONS

The SGND pin is an input reference and must be connected to the headphone ground connector pin. This ensures no turn-on pop and minimizes output offset voltage. Do not connect more than  $\pm 0.3$  V to SGND.

AGND is a power ground. Connect supply decoupling capacitors for AVDD, HPVDD, and HPVSS to AGND.

### BOARD LAYOUT

In making the pad size for the WCSP balls, it is recommended that the layout use non-solder-mask defined (NSMD) land. With this method, the solder mask opening is made larger than the desired land area, and the opening size is defined by the copper pad width. [Figure 29](#) and [Table 1](#) shows the appropriate diameters for a WCSP layout.



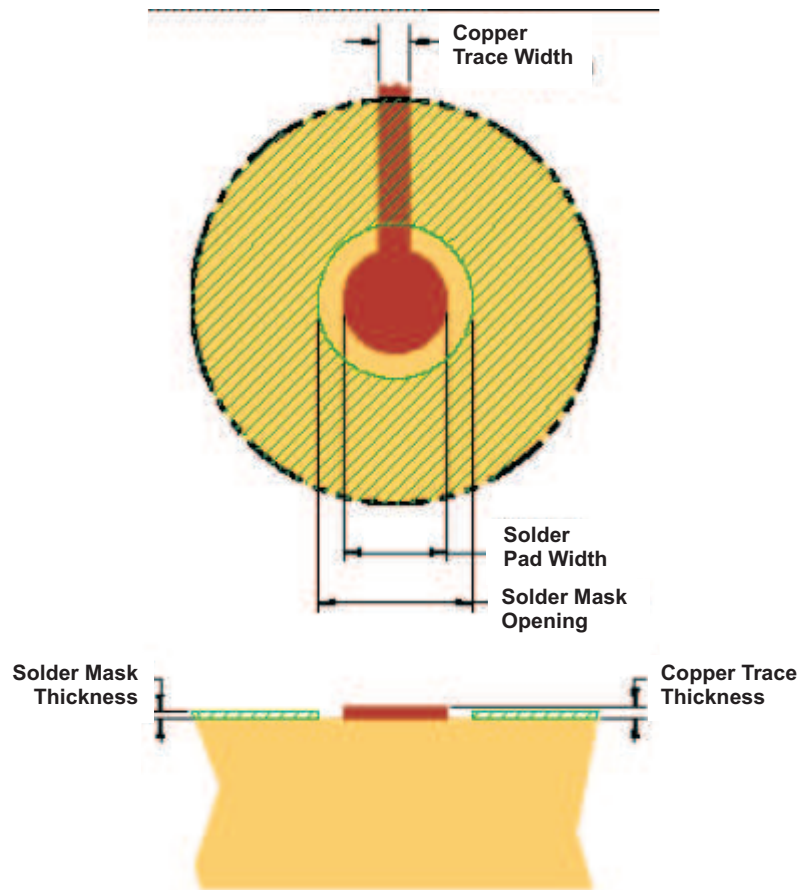

Figure 29. Land Pattern Dimensions

Table 1. Land Pattern Dimensions<sup>(1) (2) (3) (4)</sup>

SOLDER PAD DEFINITIONS	COPPER PAD	SOLDER MASK <sup>(5)</sup> OPENING	COPPER THICKNESS	STENCIL <sup>(6) (7)</sup> OPENING	STENCIL THICKNESS
Non-solder-mask defined (NSMD)	230 $\mu\text{m}$ (+0.0, -25 $\mu\text{m}$ )	310 $\mu\text{m}$ (+0.0, -25 $\mu\text{m}$ )	1 oz max (32 $\mu\text{m}$ )	275 $\mu\text{m}$ x 275 $\mu\text{m}$ Sq. (rounded corners)	100 $\mu\text{m}$ thick

- (1) Circuit traces from NSMD defined PWB lands should be 75  $\mu\text{m}$  to 100  $\mu\text{m}$  wide in the exposed area inside the solder mask opening. Wider trace widths reduce device stand off and impact reliability.
- (2) Best reliability results are achieved when the PWB laminate glass transition temperature is above the operating the range of the intended application
- (3) Recommend solder paste is Type 3 or Type 4.
- (4) For a PWB using a Ni/Au surface finish, the gold thickness should be less 0,5 mm to avoid a reduction in thermal fatigue performance.
- (5) Solder mask thickness should be less than 20  $\mu\text{m}$  on top of the copper circuit pattern
- (6) Best solder stencil performance is achieved using laser cut stencils with electro polishing. Use of chemically etched stencils results in inferior solder paste volume control.
- (7) Trace routing away from WCSP device should be balanced in X and Y directions to avoid unintentional component movement due to solder wetting forces.

## TRACE WIDTH

Recommended trace width at the solder balls is 75  $\mu\text{m}$  to 100  $\mu\text{m}$  to prevent solder wicking onto wider PCB traces. For high current pins (VDD, HPVDD, HPVSS, CPP, CPN, OUTL, and OUTR) of the TPA6141A2, use 100  $\mu\text{m}$  trace widths at the solder balls and at least 500  $\mu\text{m}$  PCB traces to ensure proper performance and output power for the device. For the remaining signals of the TPA6141A2, use 75  $\mu\text{m}$  to 100  $\mu\text{m}$  trace widths at the solder balls. The audio input pins (INL-, INL+, INR- and INR+) must run side-by-side to maximize common-mode noise cancellation.

## Package Dimensions

D	E
Max = 1590 $\mu\text{m}$	Max = 1590 $\mu\text{m}$
Min = 1530 $\mu\text{m}$	Min = 1530 $\mu\text{m}$

**PACKAGING INFORMATION**

Orderable Device	Status (1)	Package Type	Package Drawing	Pins	Package Qty	Eco Plan (2)	Lead finish/ Ball material (6)	MSL Peak Temp (3)	Op Temp (°C)	Device Marking (4/5)	Samples
TPA6141A2YFFR	ACTIVE	DSBGA	YFF	16	3000	RoHS & Green	SNAGCU	Level-1-260C-UNLIM	-40 to 85	ASBI	<a href="#">Samples</a>
TPA6141A2YFFT	ACTIVE	DSBGA	YFF	16	250	RoHS & Green	SNAGCU	Level-1-260C-UNLIM	-40 to 85	ASBI	<a href="#">Samples</a>

(1) The marketing status values are defined as follows:

**ACTIVE:** Product device recommended for new designs.

**LIFEBUY:** TI has announced that the device will be discontinued, and a lifetime-buy period is in effect.

**NRND:** Not recommended for new designs. Device is in production to support existing customers, but TI does not recommend using this part in a new design.

**PREVIEW:** Device has been announced but is not in production. Samples may or may not be available.

**OBSOLETE:** TI has discontinued the production of the device.

(2) **RoHS:** TI defines "RoHS" to mean semiconductor products that are compliant with the current EU RoHS requirements for all 10 RoHS substances, including the requirement that RoHS substance do not exceed 0.1% by weight in homogeneous materials. Where designed to be soldered at high temperatures, "RoHS" products are suitable for use in specified lead-free processes. TI may reference these types of products as "Pb-Free".

**RoHS Exempt:** TI defines "RoHS Exempt" to mean products that contain lead but are compliant with EU RoHS pursuant to a specific EU RoHS exemption.

**Green:** TI defines "Green" to mean the content of Chlorine (Cl) and Bromine (Br) based flame retardants meet JS709B low halogen requirements of <=1000ppm threshold. Antimony trioxide based flame retardants must also meet the <=1000ppm threshold requirement.

(3) MSL, Peak Temp. - The Moisture Sensitivity Level rating according to the JEDEC industry standard classifications, and peak solder temperature.

(4) There may be additional marking, which relates to the logo, the lot trace code information, or the environmental category on the device.

(5) Multiple Device Markings will be inside parentheses. Only one Device Marking contained in parentheses and separated by a "~" will appear on a device. If a line is indented then it is a continuation of the previous line and the two combined represent the entire Device Marking for that device.

(6) Lead finish/Ball material - Orderable Devices may have multiple material finish options. Finish options are separated by a vertical ruled line. Lead finish/Ball material values may wrap to two lines if the finish value exceeds the maximum column width.

**Important Information and Disclaimer:**The information provided on this page represents TI's knowledge and belief as of the date that it is provided. TI bases its knowledge and belief on information provided by third parties, and makes no representation or warranty as to the accuracy of such information. Efforts are underway to better integrate information from third parties. TI has taken and continues to take reasonable steps to provide representative and accurate information but may not have conducted destructive testing or chemical analysis on incoming materials and chemicals. TI and TI suppliers consider certain information to be proprietary, and thus CAS numbers and other limited information may not be available for release.

In no event shall TI's liability arising out of such information exceed the total purchase price of the TI part(s) at issue in this document sold by TI to Customer on an annual basis.



**TAPE AND REEL INFORMATION**

**QUADRANT ASSIGNMENTS FOR PIN 1 ORIENTATION IN TAPE**

\*All dimensions are nominal

Device	Package Type	Package Drawing	Pins	SPQ	Reel Diameter (mm)	Reel Width W1 (mm)	A0 (mm)	B0 (mm)	K0 (mm)	P1 (mm)	W (mm)	Pin1 Quadrant
TPA6141A2YFFR	DSBGA	YFF	16	3000	180.0	8.4	1.71	1.71	0.81	4.0	8.0	Q1
TPA6141A2YFFT	DSBGA	YFF	16	250	180.0	8.4	1.71	1.71	0.81	4.0	8.0	Q1

**TAPE AND REEL BOX DIMENSIONS**

\*All dimensions are nominal

Device	Package Type	Package Drawing	Pins	SPQ	Length (mm)	Width (mm)	Height (mm)
TPA6141A2YFFR	DSBGA	YFF	16	3000	182.0	182.0	20.0
TPA6141A2YFFT	DSBGA	YFF	16	250	182.0	182.0	20.0

YFF0016

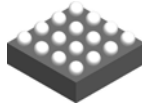

# PACKAGE OUTLINE

DSBGA - 0.625 mm max height

DIE SIZE BALL GRID ARRAY

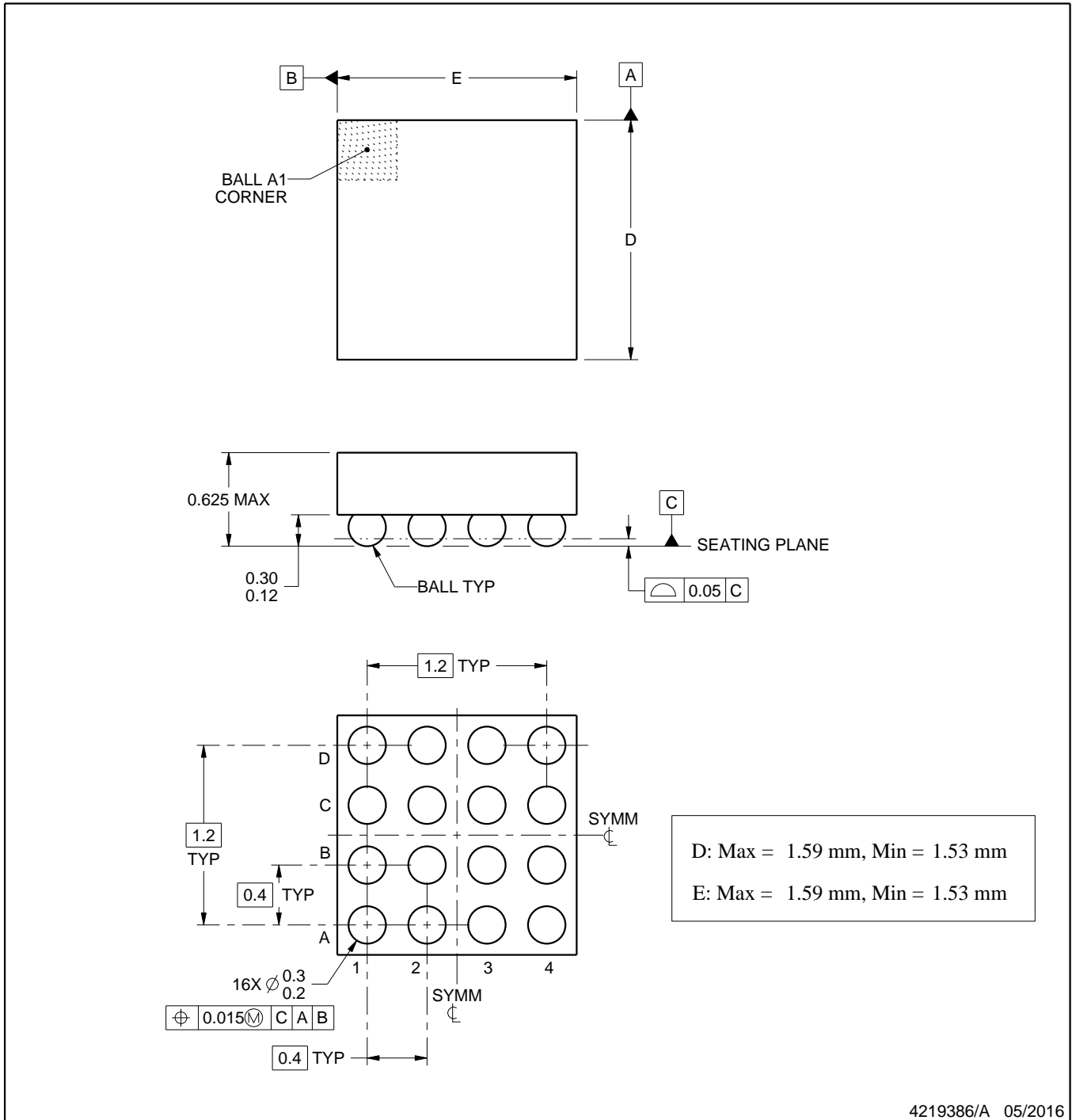

NOTES:

1. All linear dimensions are in millimeters. Any dimensions in parenthesis are for reference only. Dimensioning and tolerancing per ASME Y14.5M.
2. This drawing is subject to change without notice.

# EXAMPLE BOARD LAYOUT

YFF0016

DSBGA - 0.625 mm max height

DIE SIZE BALL GRID ARRAY

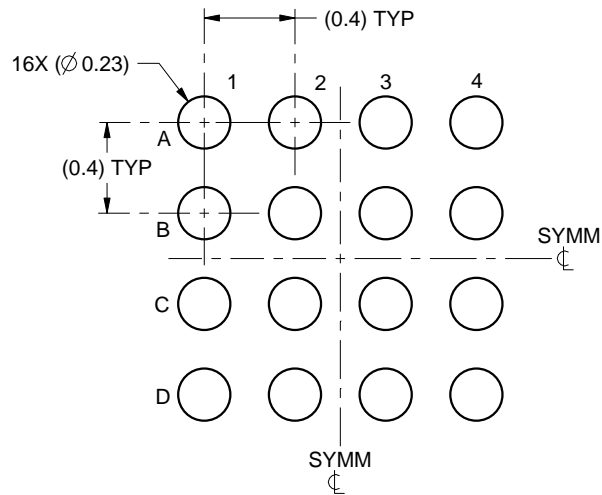

LAND PATTERN EXAMPLE  
SCALE:30X

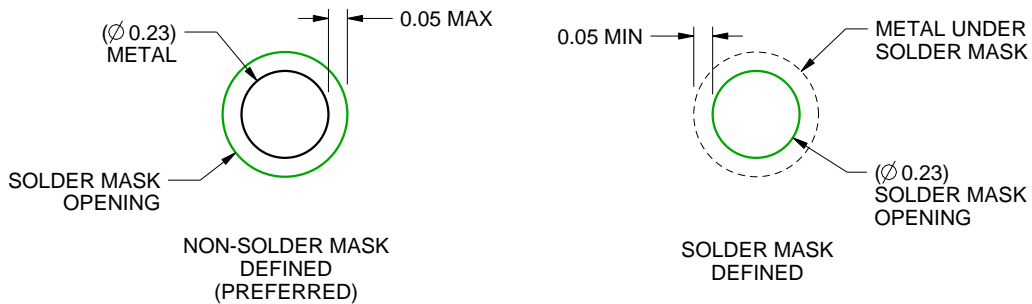

SOLDER MASK DETAILS  
NOT TO SCALE

4219386/A 05/2016

NOTES: (continued)

3. Final dimensions may vary due to manufacturing tolerance considerations and also routing constraints. For more information, see Texas Instruments literature number SNVA009 ([www.ti.com/lit/snva009](http://www.ti.com/lit/snva009)).



# EXAMPLE STENCIL DESIGN

YFF0016

DSBGA - 0.625 mm max height

DIE SIZE BALL GRID ARRAY

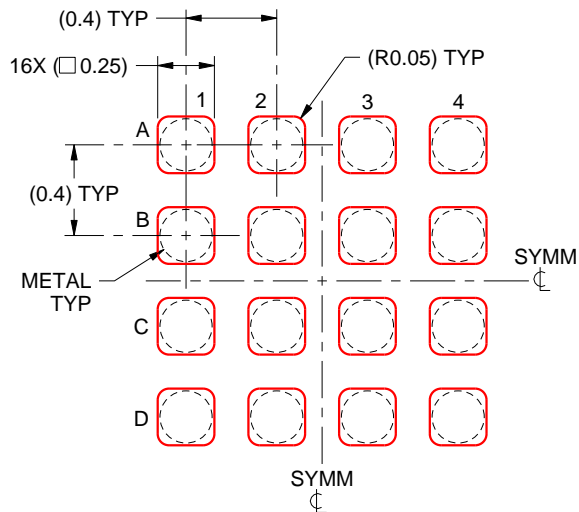

SOLDER PASTE EXAMPLE  
BASED ON 0.1 mm THICK STENCIL  
SCALE:30X

4219386/A 05/2016

NOTES: (continued)

4. Laser cutting apertures with trapezoidal walls and rounded corners may offer better paste release.

## IMPORTANT NOTICE AND DISCLAIMER

TI PROVIDES TECHNICAL AND RELIABILITY DATA (INCLUDING DATA SHEETS), DESIGN RESOURCES (INCLUDING REFERENCE DESIGNS), APPLICATION OR OTHER DESIGN ADVICE, WEB TOOLS, SAFETY INFORMATION, AND OTHER RESOURCES "AS IS" AND WITH ALL FAULTS, AND DISCLAIMS ALL WARRANTIES, EXPRESS AND IMPLIED, INCLUDING WITHOUT LIMITATION ANY IMPLIED WARRANTIES OF MERCHANTABILITY, FITNESS FOR A PARTICULAR PURPOSE OR NON-INFRINGEMENT OF THIRD PARTY INTELLECTUAL PROPERTY RIGHTS.

These resources are intended for skilled developers designing with TI products. You are solely responsible for (1) selecting the appropriate TI products for your application, (2) designing, validating and testing your application, and (3) ensuring your application meets applicable standards, and any other safety, security, regulatory or other requirements.

These resources are subject to change without notice. TI grants you permission to use these resources only for development of an application that uses the TI products described in the resource. Other reproduction and display of these resources is prohibited. No license is granted to any other TI intellectual property right or to any third party intellectual property right. TI disclaims responsibility for, and you will fully indemnify TI and its representatives against, any claims, damages, costs, losses, and liabilities arising out of your use of these resources.

TI's products are provided subject to [TI's Terms of Sale](#) or other applicable terms available either on [ti.com](https://www.ti.com) or provided in conjunction with such TI products. TI's provision of these resources does not expand or otherwise alter TI's applicable warranties or warranty disclaimers for TI products.

TI objects to and rejects any additional or different terms you may have proposed.

Mailing Address: Texas Instruments, Post Office Box 655303, Dallas, Texas 75265  
Copyright © 2023, Texas Instruments Incorporated