

# TAS2764 Digital Input Mono Class-D Audio Amplifier With Speaker IV Sense

## 1 Features

- Key Features
  - Y-Bridge Power Architecture
  - Edge and Spread Spectrum Control
  - Full Scale Ultrasonic Output up to 40 kHz
- Output Power (1 % THD+N)
  - 13 W (4  $\Omega$ , 12 V)
  - 8 W (8  $\Omega$ , 12 V)
- Power Consumption (1 % THD+N, 4  $\Omega$ , 12 V)
  - 81% Efficient at 1W
  - 85% Efficient at 13W
  - 3mA in Noise Gate Mode
  - <1uA in Hardware Shutdown Mode
- Power Supplies and Management
  - PVDD: 2.3 V to 16 V
  - VBAT1S: 2.3 V to 5.5 V
  - AVDD: 1.8 V
  - IOVDD: 1.2 V/ 1.8 V
  - Brownout Protection
  - PVDD Tracking Peak Voltage Limiter
- Interfaces and Control
  - SDOUT and I<sup>2</sup>S Feedback for Echo Cancellation
  - I<sup>2</sup>S/TDM: 8 Channels of 32-bit up to 96 kHz
  - I<sup>2</sup>C: 8 addresses with Fast Mode Plus Support
  - 44.1 kHz to 96 kHz Sample Rates
  - Inter Chip Communication Bus
- Integrated Speaker Management and Protection
  - Speaker Voltage and Current Sense
  - Short and Open Detection
  - Thermal and Over Current Protection
  - Over Power Protection

## 2 Applications

- Laptop Computers
- Tablets
- Wireless Speakers
- Smart Speakers
- Consumer Audio Devices

## 3 Description

The TAS2764 is a mono digital input Class-D audio amplifier optimized for efficiently driving high peak power into small loudspeakers. The Class-D amplifier is capable of delivering 13 W of continuous power into a 4  $\Omega$  load with less than 1 % THD+N at a supply voltage of 12 V.

Y-Bridge architecture improves overall efficiency at low level of output power and in idle mode.

Integrated speaker voltage and current sense provides for real time monitoring of loudspeaker behavior. A supply tracking peak voltage limiter optimizes amplifier headroom. Brownout prevention scheme with multiple thresholds allows reducing the gain in signal path when the supply drops.

TAS2764 ultrasonic output support allows device to be used for advance ultrasonic applications like motion and proximity detection, gesture recognition, etc.

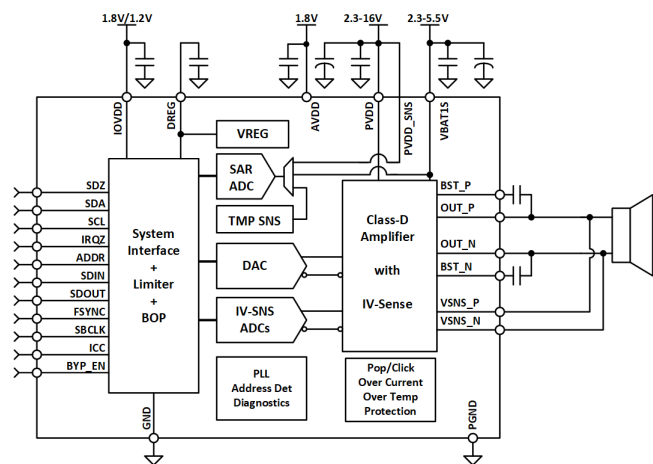
Up to eight TAS2764 devices can share a common bus via I<sup>2</sup>S/TDM and I<sup>2</sup>C interfaces.

The device is available in a 30-ball, 0.4 mm pitch CSP for a compact PCB footprint.

### Device Information<sup>(1)</sup>

PART NUMBER	PACKAGE	BODY SIZE (NOM)
TAS2764	DSBGA	2.128 mm x 2.542 mm

- (1) For all available packages, see the orderable addendum at the end of the data sheet.



Schematic



## Table of Contents

<b>1 Features</b> .....	1	9.1 Application Information.....	87
<b>2 Applications</b> .....	1	9.2 Typical Application.....	87
<b>3 Description</b> .....	1	9.3 Design Requirements.....	88
<b>4 Revision History</b> .....	2	9.4 Detailed Design Procedure.....	88
<b>5 Pin Configuration and Functions</b> .....	3	9.5 Application Curves.....	89
<b>6 Specifications</b> .....	5	<b>10 Initialization Set Up</b> .....	90
6.1 Absolute Maximum Ratings.....	5	10.1 Recommended Configuration at Power Up.....	90
6.2 ESD Ratings.....	5	10.2 Initial Device Configuration - 4 Channel Power Up (Default Mode - PWR_MODE1).....	90
6.3 Recommended Operating Conditions.....	5	10.3 Initial Device Configuration - 44.1 kHz.....	91
6.4 Thermal Information.....	5	10.4 Sample Rate Change - 48 kHz to 44.1kHz.....	91
6.5 Electrical Characteristics.....	6	10.5 Idle Channel Hysteresis.....	91
6.6 I <sup>2</sup> C Timing Requirements.....	11	10.6 DSP Loopback.....	91
6.7 TDM Port Timing Requirements.....	12	<b>11 Power Supply and I<sup>2</sup>C Recommendations</b> .....	92
6.8 Typical Characteristics.....	13	11.1 Power Supply Modes.....	92
<b>7 Parameter Measurement Information</b> .....	23	<b>12 Layout</b> .....	94
<b>8 Detailed Description</b> .....	24	12.1 Layout Guidelines.....	94
8.1 Overview.....	24	12.2 Layout Example.....	94
8.2 Functional Block Diagram.....	24	<b>13 Device and Documentation Support</b> .....	96
8.3 Feature Description.....	24	13.1 Receiving Notification of Documentation Updates.....	96
8.4 Device Functional Modes.....	26	13.2 Support Resources.....	96
8.5 Operational Modes.....	37	13.3 Trademarks.....	96
8.6 Faults and Status.....	38	13.4 Electrostatic Discharge Caution.....	96
8.7 Power Sequencing Requirements.....	41	13.5 Glossary.....	96
8.8 Digital Input Pull Downs.....	41	<b>14 Mechanical, Packaging, and Orderable   Information</b> .....	97
8.9 Register Map.....	41		
8.10 SDOOUT Equations.....	86		
<b>9 Application and Implementation</b> .....	87		

## 4 Revision History

NOTE: Page numbers for previous revisions may differ from page numbers in the current version.

Changes from Revision * (December 2020) to Revision A (September 2021)	Page
• Changed device status to Production Data from Advanced Information.....	1

## 5 Pin Configuration and Functions

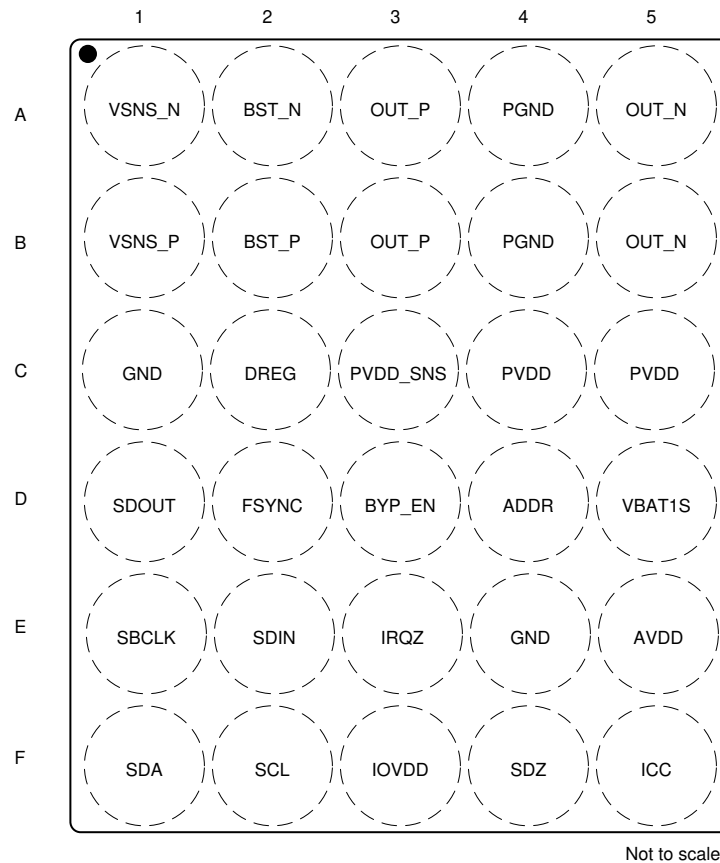


Figure 5-1. YBH Package 30-Ball DSBGA Top View

Table 5-1. Pin Functions

PIN		I/O	DESCRIPTION
NAME	NO.		
ADDR	D4	I	Address detect pin. Resistor value at this pin selects the I <sup>2</sup> C address. See <a href="#">Section 8.3.1</a> . Minimize capacitive loading on this pin and do not connect to any other load.
AVDD	E5	P	Analog power input. Connect to 1.8V supply and decouple to GND with a capacitor.
BST_N	A2	P	Class-D negative bootstrap. Connect a capacitor between BST_N and OUT_N.
BST_P	B2	P	Class-D positive bootstrap. Connect a capacitor between BST_P and OUT_P.
DREG	C2	P	Digital core voltage regulator output. Bypass to GND with a capacitor. Do not connect to external load.
FSYNC	D2	I	TDM Frame Sync.
GND	E4 C1	P	Analog ground. Connect to PCB ground plane.
ICC	F5	IO	Interchip communication pin used to transmit gain alignment.
IOVDD	F3	P	Digital IO Supply. Connect to 1.2V or 1.8 V supply and decouple with a capacitor to GND.
IRQZ	E3	O	Open drain, active low interrupt pin. Pull up to IOVDD with resistor if optional internal pull up is not used.
BYP_EN	D3	O	Low voltage signaling pin with open drain output. It can be used to enable/disable an external converter.
OUT_N	B5 A5	O	Class-D negative output.

**Table 5-1. Pin Functions (continued)**

PIN		I/O	DESCRIPTION
NAME	NO.		
OUT_P	B3 A3	O	Class-D positive output.
PGND	B4 A4	P	Class-D ground. Connect to PCB ground plane.
SBCLK	E1	I	TDM Serial Bit Clock.
SCL	F2	I	I <sup>2</sup> C Clock Pin. Pull up to IOVDD with a resistor.
SDA	F1	IO	I <sup>2</sup> C Data Pin. Pull up to IOVDD with a resistor.
SDIN	E2	I	TDM Serial Data Input.
SDOUT	D1	IO	TDM Serial Data Output.
SDZ	F4	I	Active low hardware shutdown.
PVDD	C4 C5	P	Class-D power supply input. Decouple with a capacitor.
PVDD_SNS	C3	I	PVDD remote sense pin.
VBAT1S	D5	P	Single-cell battery supply input. Decouple with a capacitor.
VSNS_N	A1	I	Voltage Sense negative input. Connect to one speaker input.
VSNS_P	B1	I	Voltage Sense positive input. Connect to the other speaker input.

## 6 Specifications

### 6.1 Absolute Maximum Ratings

over operating free-air temperature range (unless otherwise noted) <sup>(1)</sup>

		MIN	MAX	UNIT
Supply Voltage	AVDD	-0.3	2	V
	IOVDD	-0.3	2	V
	PVDD	-0.3	18.5	V
	VBAT1S	-0.3	6	V
	PVDD-VBAT1S	-0.3	18	V
Internal Supply Voltage	DREG	-0.3	1.5	V
Input voltage <sup>(2)</sup>	Digital IOs referenced to IOVDD supply	-0.3	2.3	V
Operating free-air temperature, T <sub>A</sub> ; Device is functional and reliable, some performance characteristics may be degraded.		-40	85	°C
Performance free-air temperature, T <sub>P</sub> ; All performance characteristics are met.		-20	70	°C
Operating junction temperature, T <sub>J</sub>		-40	125	°C
Storage temperature, T <sub>stg</sub>		-65	150	°C

- (1) Stresses beyond those listed under [Section 6.1](#) can cause permanent damage to the device. These are stress ratings only, which do not imply functional operation of the device at these or any other conditions beyond those indicated under [Section 6.3](#). Exposure to absolute maximum rated conditions for extended periods can affect device reliability.
- (2) All digital inputs and IOs are failsafe.

### 6.2 ESD Ratings

			VALUE	UNIT
V <sub>(ESD)</sub>	Electrostatic discharge	Human-body model (HBM), per ANSI/ESDA/JEDEC JS-001 <sup>(1)</sup>	±2000	V
		Charged-device model (CDM), per JEDEC specification JESD22-C101 <sup>(2)</sup>	±500	

- (1) JEDEC document JEP155 states that 500-V HBM allows safe manufacturing with a standard ESD control process.
- (2) JEDEC document JEP157 states that 250-V CDM allows safe manufacturing with a standard ESD control process.

### 6.3 Recommended Operating Conditions

over operating free-air temperature range (unless otherwise noted)

		MIN	NOM	MAX	UNIT
AVDD	Supply voltage	1.65	1.8	1.95	V
IOVDD	Supply voltage	1.1	1.2	1.3	V
		1.65	1.8	1.95	
PVDD	Supply voltage (functional) <sup>(1)</sup>	2.3 <sup>(2)</sup>		16	V
	Supply voltage (performance)	3.0		16	
VBAT1S	Supply voltage (functional) <sup>(1)</sup>	2.3		5.5	V
	Supply voltage (performance)	3.0		5.5	
V <sub>IH</sub>	High-level digital input voltage		IOVDD		V
V <sub>IL</sub>	Low-level digital input voltage		0		V
R <sub>SPK</sub>	Speaker impedance	3.2			Ω
L <sub>SPK</sub>	Speaker inductance	5			μH

- (1) Device will remain functional but performance will degrade.
- (2) PVDD > VBAT1S - 0.7V.

### 6.4 Thermal Information

THERMAL METRIC <sup>(1)</sup>		TAS2764	UNIT
		YBH (DSBGA)	
		30 PINS	
R <sub>θJA</sub>	Junction-to-ambient thermal resistance	59.9	°C/W

THERMAL METRIC <sup>(1)</sup>		TAS2764	
		YBH (DSBGA)	
		30 PINS	
			UNIT
R <sub>θJC(top)</sub>	Junction-to-case (top) thermal resistance	0.2	°C/W
R <sub>θJB</sub>	Junction-to-board thermal resistance	14.9	°C/W
Ψ <sub>JT</sub>	Junction-to-top characterization parameter	0.1	°C/W
Ψ <sub>JB</sub>	Junction-to-board characterization parameter	14.9	°C/W

(1) For more information about traditional and new thermal metrics, see the *Semiconductor and IC Package Thermal Metrics* application report, [SPRA953](#).

## 6.5 Electrical Characteristics

T<sub>A</sub> = 25 °C, PVDD = 12 V, VBAT1S = 3.8 V, AVDD = 1.8V IOVDD = 1.2 V, R<sub>L</sub> = 4Ω + 16μH, f<sub>in</sub> = 1 kHz, f<sub>s</sub> = 48 kHz, Gain = 21 dBV, SDZ = 1, EDGE\_RATE[1:0]=00, NG\_EN=0, EN\_LLSR=1, PWR\_MODE1, Measured filter free as in Section 7 (unless otherwise noted).

PARAMETER		TEST CONDITIONS	MIN	TYP	MAX	UNIT
<b>DIGITAL INPUT and OUTPUT</b>						
V <sub>IH</sub>	High-level digital input logic voltage threshold	All digital pins except SDA and SCL	0.7×IOVDD			V
V <sub>IL</sub>	Low-level digital input logic voltage threshold	All digital pins except SDA and SCL			0.3 × IOVDD	V
V <sub>IH(I2C)</sub>	High-level digital input logic voltage threshold	SDA and SCL	0.7×IOVDD			V
V <sub>IL(I2C)</sub>	Low-level digital input logic voltage threshold	SDA and SCL			0.3 × IOVDD	V
V <sub>OH</sub>	High-level digital output voltage	All digital pins except SDA, SCL and IRQZ; I <sub>OH</sub> = 100 μA.	IOVDD–0.2V			V
V <sub>OL</sub>	Low-level digital output voltage	All digital pins except SDA, SCL and IRQZ; I <sub>OL</sub> = –100 μA.			0.2	V
V <sub>OL(I2C)</sub>	Low-level digital output voltage	SDA and SCL; I <sub>OL(I2C)</sub> = –1 mA.			0.2 × IOVDD	V
V <sub>OL(IRQZ)</sub>	Low-level digital output voltage for IRQZ open drain Output	IRQZ; I <sub>OL(IRQZ)</sub> = –1 mA.			0.2	V
I <sub>IH</sub>	Input logic-high leakage for digital inputs	All digital pins; Input = IOVDD.	–1		1	μA
I <sub>IL</sub>	Input logic-low leakage for digital inputs	All digital pins; Input = GND.	–1		1	μA
R <sub>OS</sub>	OUT to VSNS Resistors	Load disconnected			10	kΩ
C <sub>IN</sub>	Input capacitance for digital inputs	All digital pins			5	pF
R <sub>PD</sub>	Pull down resistance for IO pins when asserted on	SDOUT, SDIN, FSYNC, SBCLK			18	kΩ
IO	Output Current Strength	Drive Mode 0 - Measured at (IOVDD-0.4V) and 0.4V			8	mA
		Drive Mode 1 - Measured at (IOVDD-0.4V) and 0.4V			6	
		Drive Mode 2 - Measured at (IOVDD-0.4V) and 0.4V			4	
		Drive Mode 3 - Measured at (IOVDD-0.4V) and 0.4V			2	
<b>AMPLIFIER PERFORMANCE</b>						
P <sub>OUT</sub>	Maximum Output Power	R <sub>L</sub> = 4Ω + 16μH, THD+N = 1 %			13	W
		R <sub>L</sub> = 8 Ω + 16 μH, THD+N = 1 %			8	
		R <sub>L</sub> = 4Ω + 16μH, THD+N = 10 %			15.8	
		R <sub>L</sub> = 8 Ω + 16 μH, THD+N = 10 %			9.7	
System Efficiency		R <sub>L</sub> = 4Ω + 16μH, P <sub>OUT</sub> = 1 W			80.5	%
		R <sub>L</sub> = 8 Ω + 16 μH, P <sub>OUT</sub> = 1 W			84	
		R <sub>L</sub> = 8 Ω + 5μH, P <sub>OUT</sub> = 1 W PWR_MODE2			76.5	
		R <sub>L</sub> = 8 Ω + 16μH, P <sub>OUT</sub> = 1 W PWR_MODE2			82.5	
		R <sub>L</sub> = 4Ω + 16μH, P <sub>OUT</sub> = 10 W			85	
		R <sub>L</sub> = 8 Ω + 16 μH, P <sub>OUT</sub> = 5 W			90	
		R <sub>L</sub> = 8 Ω + 5 μH, P <sub>OUT</sub> = 8 W, PWR_MODE2			90	

$T_A = 25\text{ }^\circ\text{C}$ ,  $PVDD = 12\text{ V}$ ,  $VBAT1S = 3.8\text{ V}$ ,  $AVDD = 1.8\text{ V}$   $IOVDD = 1.2\text{ V}$ ,  $R_L = 4\Omega + 16\mu\text{H}$ ,  $f_{in} = 1\text{ kHz}$ ,  $f_s = 48\text{ kHz}$ ,  $\text{Gain} = 21\text{ dBV}$ ,  $\text{SDZ} = 1$ ,  $\text{EDGE\_RATE}[1:0]=00$ ,  $\text{NG\_EN}=0$ ,  $\text{EN\_LLSR}=1$ ,  $\text{PWR\_MODE1}$ , Measured filter free as in Section 7 (unless otherwise noted).

PARAMETER		TEST CONDITIONS	MIN	TYP	MAX	UNIT
THD+N	Total Harmonic Distortion and Noise	$P_{OUT} = 1\text{ W}$ , $R_L = 4\Omega + 16\mu\text{H}$ , $f_{in} = 1\text{ kHz}$		-83		dB
		$P_{OUT} = 1\text{ W}$ , $R_L = 4\Omega + 16\mu\text{H}$ , $f_{in} = 6.67\text{ kHz}$		-83		
		$P_{OUT} = 1\text{ W}$ , $R_L = 8\Omega + 5\mu\text{H}$ , $f_{in} = 20\text{ Hz} - 20\text{ kHz}$ , $\text{PWR\_MODE2}$		-83		
IMD	Intermodulation Distortion	ITU-R, 19kHz/20kHz, 1:1:6.5W		-80		dB
$V_N$	Idle Channel Noise	A-Weighted, 20 Hz - 20 kHz, DAC in Mute, $\text{PWR\_MODE1}$		27		$\mu\text{V}$
		A-Weighted, 20 Hz - 20 kHz, DAC in Mute, $\text{PWR\_MODE2}$		27		
		A-Weighted, 20 Hz - 20 kHz, DAC in Mute, $\text{PWR\_MODE4}$		32.7		
$F_{PWM}$	Class-D PWM Switching Frequency	Average frequency in Spread Spectrum Mode, $\text{CLASSD\_SYNC}=0$		384		kHz
		Fixed Frequency Mode, $\text{CLASSD\_SYNC}=0$	365	384	404	
		Fixed Frequency Mode, $\text{CLASSD\_SYNC}=1$ , $f_s = 44.1, 88.2\text{ kHz}$		352.8		
		Fixed Frequency Mode, $\text{CLASSD\_SYNC}=1$ , $f_s = 48, 96\text{ kHz}$		384		
$V_{OS}$	Output Offset Voltage	Idle Mode	-1		1	mV
DNR	Dynamic Range	A-Weighted, -60 dBFS		109		dB
		A-Weighted, -60 dBFS, $\text{PWR\_MODE2}$		109		
SNR	Signal to Noise Ratio	A-Weighted, Referenced to 1 % THD+N Output Level		109		dB
		A-Weighted, Referenced to 1 % THD+N Output Level $\text{PWR\_MODE2}$		109		
$K_{CP}$	Click and Pop Performance	Into and out of Shutdown, A-weighted		1	2.7	mV
	Full Scale Output Voltage	$f_s \leq 48\text{ kHz}$		21		dBV
	Minimum Programmable Gain	$f_s \leq 48\text{ kHz}$		11		dBV
	Maximum Programmable Gain	$f_s \leq 48\text{ kHz}$		21		dBV
	Programmable Output Level Step Size			0.5		dB
	Mute attenuation	Device in Software Shutdown or Muted in Normal Operation		110		dB
	Chip to Chip Group Delay		-1		1	$\mu\text{s}$
	EMI Margin to EN55022B	6" cable, $P_{out} = 1\text{ W}$		-6		dB
	PVDD Power Supply Rejection Ratio	$PVDD = 12\text{ V} + 200\text{ mV}_{pp}$ , $f_{ripple} = 217\text{ Hz}$		100		dB
		$PVDD = 12\text{ V} + 200\text{ mV}_{pp}$ , $f_{ripple} = 1\text{ kHz}$		112		
		$PVDD = 12\text{ V} + 200\text{ mV}_{pp}$ , $f_{ripple} = 20\text{ kHz}$		96		
	VBAT1S Power Supply Rejection Ratio	$VBAT1S = 3.8\text{ V} + 200\text{ mV}_{pp}$ , $f_{ripple} = 217\text{ Hz}$		100		dB
		$VBAT1S = 3.8\text{ V} + 200\text{ mV}_{pp}$ , $f_{ripple} = 1\text{ kHz}$		112		
		$VBAT1S = 3.8\text{ V} + 200\text{ mV}_{pp}$ , $f_{ripple} = 20\text{ kHz}$		88		
	AVDD Power Supply Rejection Ratio	$AVDD = 1.8\text{ V} + 200\text{ mV}_{pp}$ , $f_{ripple} = 217\text{ Hz}$		96		dB
		$AVDD = 1.8\text{ V} + 200\text{ mV}_{pp}$ , $f_{ripple} = 1\text{ kHz}$		90		
		$AVDD = 1.8\text{ V} + 200\text{ mV}_{pp}$ , $f_{ripple} = 20\text{ kHz}$		96		
	Power Supply Intermodulation	$PVDD$ 217 Hz, 100-mVpp, Input f=1kHz @ 400mW		-70		dB
		$VBAT1S$ 217 Hz, 100-mVpp, Input f=1kHz @ 400mW		-118		
		$AVDD$ , 217 Hz, 100-mVpp, Input f=1kHz @ 400mW		-82		
		$IOVDD$ 217 Hz, 100-mVpp, Input f=1kHz @ 400mW		-70		
	Turn ON Time from Release of SW Shutdown	No Volume Ramping		1.2		ms
		Volume Ramping		5.3		
	Turn OFF Time From Assertion of SW Shutdown to Amp Hi-Z	No Volume Ramping		0.5		ms
		Volume Ramping		5.9		
	Release of SW Shutdown to new assertion of SW Shutdown		1.5			ms
	Out of HW Shutdown to first I <sup>2</sup> C command		1			ms

**TAS2764**

SLOS998A – DECEMBER 2020 – REVISED SEPTEMBER 2021

$T_A = 25\text{ }^\circ\text{C}$ ,  $PVDD = 12\text{ V}$ ,  $V_{BAT1S} = 3.8\text{ V}$ ,  $AVDD = 1.8\text{V}$   $IOVDD = 1.2\text{ V}$ ,  $R_L = 4\Omega + 16\mu\text{H}$ ,  $f_{in} = 1\text{ kHz}$ ,  $f_s = 48\text{ kHz}$ ,  $\text{Gain} = 21\text{ dBV}$ ,  $\text{SDZ} = 1$ ,  $\text{EDGE\_RATE}[1:0]=00$ ,  $\text{NG\_EN}=0$ ,  $\text{EN\_LLSR}=1$ ,  $\text{PWR\_MODE}1$ , Measured filter free as in Section 7 (unless otherwise noted).

PARAMETER		TEST CONDITIONS	MIN	TYP	MAX	UNIT
	Noise Gate recovery to Shutdown latency		100			$\mu\text{s}$
	Power up to BOP_SHDN latency		1.5			ms
<b>DIAGNOSTIC GENERATOR</b>						
THD+N	Total Harmonic Distortion and Noise	Pout=1W, DVC_LVL[7:0]=17h		-80		dB
$f_{err}$	Frequency Error	Using internal oscillator			5	%
<b>DIE TEMPERATURE SENSOR</b>						
	Resolution			8		bits
	Minimum Die Temperature Measurement			-40		$^\circ\text{C}$
	Maximum Die Temperature Measurement			150		$^\circ\text{C}$
	Die Temperature Resolution			1		$^\circ\text{C}$
	Die Temperature Accuracy		-5		5	$^\circ\text{C}$
<b>VOLTAGE MONITOR</b>						
	Resolution			12		bits
	Minimum PVDD Measurement			2		V
	Maximum PVDD Measurements			16		V
	PVDD Resolution			20		mV
	PVDD Accuracy		-100		100	mV
	Minimum VBAT1S Measurement			2		V
	Maximum VBAT1S Measurement			6		V
	VBAT1S Resolution			20		mV
	VBAT1S Accuracy		-45		45	mV
<b>TDM SERIAL AUDIO PORT</b>						
	PCM Sample Rates and FSYNC Input Frequency	Typical values	44.1		96	kHz
	SBCLK Input Frequency	I <sup>2</sup> S/TDM Operation	0.7056		24.576	MHz
	SBCLK Maximum Input Jitter	RMS Jitter below 40 kHz that can be tolerated without performance degradation			0.5	ns
		RMS Jitter above 40 kHz that can be tolerated without performance degradation			1	
	SBCLK Cycles per FSYNC in I <sup>2</sup> S and TDM Modes	Other values: 24, 32, 48, 64, 96, 125, 128, 192, 250, 256, 384, 500	16		512	Cycles
<b>PCM PLAYBACK CHARACTERISTICS <math>f_s \leq 48\text{ kHz}</math></b>						
$f_s$	Sample Rates		44.1		48	kHz
	Passband Frequency Meeting Ripple			0.454		$f_s$
	Passband Ripple	20Hz to LPF cutoff frequency	-0.3		+0.3	dB
	Stop Band Attenuation	$\geq 0.55 f_s$		60		dB
		$\geq 1 f_s$			65	
	Group Delay @ 1kHz	Noise Gate Enabled		17.7		$1/f_s$
		Noise Gate Disabled		9		
	Group Delay	DC to $0.454 f_s$ , Noise Gate enabled, DC blocker disabled	16		19	$1/f_s$
		DC to $0.454 f_s$ , Noise Gate disabled, DC blocker disabled	7		10	
<b><math>f_s &gt; 48\text{ kHz}</math></b>						
$f_s$	Sample Rates		88.2		96	kHz
	Passband Frequency Meeting Ripple	$f_s = 96\text{ kHz}$		0.375		$f_s$
	Passband 3db Frequency	$f_s = 96\text{ kHz}$		0.409		$f_s$
	Passband Ripple	DC to LPF cutoff frequency	-0.5		0.5	dB



$T_A = 25\text{ }^\circ\text{C}$ ,  $PVDD = 12\text{ V}$ ,  $V_{BAT1S} = 3.8\text{ V}$ ,  $AVDD = 1.8\text{ V}$   $IOVDD = 1.2\text{ V}$ ,  $R_L = 4\Omega + 16\mu\text{H}$ ,  $f_{in} = 1\text{ kHz}$ ,  $f_s = 48\text{ kHz}$ ,  $\text{Gain} = 21\text{ dBV}$ ,  $\text{SDZ} = 1$ ,  $\text{EDGE\_RATE}[1:0]=00$ ,  $\text{NG\_EN}=0$ ,  $\text{EN\_LLSR}=1$ ,  $\text{PWR\_MODE}1$ , Measured filter free as in Section 7 (unless otherwise noted).

PARAMETER		TEST CONDITIONS	MIN	TYP	MAX	UNIT
	Stop Band Attenuation	$\geq 0.55 f_s$		60		dB
		$\geq 1 f_s$		65		
	Group Delay @ 1kHz	Noise Gate Enabled		33.2		$1/f_s$
		Noise Gate Disabled		17.4		
	Group Delay	DC to $0.375 f_s$ for 96 kHz, Noise Gate Enabled, DC blocker disabled	33		39	$1/f_s$
		DC to $0.375 f_s$ for 96 kHz, Noise Gate Disabled, DC blocker disabled	17		23	
<b>SPEAKER CURRENT SENSE</b>						
	Resolution			16		bits
DNR	Dynamic Range	Un-Weighted, Relative to 0 dBFS		66		dB
THD+N	Total Harmonic Distortion and Noise	$f_{in} = 1\text{ kHz}$ , $P_{out} = 7.5\text{ W}$		-58		dB
	Full Scale Input Current	-6dBFS Input Signal Level		3.75		A
	Differential Mode Gain	$P_{out} = 1\text{ W}$ , using a 40Hz, -40dBFS pilot tone	0.98		1.02	
	Differential Mode Gain Variability	$P_{out} = 100\text{ mW}$ to 0.1% THD+N, using a 40Hz, -40dBFS pilot tone, Calibrated at 100 mW	-1.4		1.4	%
	Gain Error Over Temperature	$-20^\circ\text{C}$ to $70^\circ\text{C}$ , $P_{out}=1\text{ W}$ , Calibrated at $25^\circ\text{C}$	-1.35		1.35	%
	Offset	HPF_FREQ_REC[2:0]=0h	-2		2	mA
	Frequency Response	20Hz-20kHz	-0.1		0.1	dB
	Group Delay			8		$1/f_s$
<b>SPEAKER VOLTAGE SENSE</b>						
	Resolution			16		bits
DNR	Dynamic Range	Un-Weighted, Relative 0 dBFS		69		dB
THD+N	Total Harmonic Distortion and Noise	$f_{in} = 1\text{ kHz}$ , $P_{out} = 7.5\text{ W}$		-60		dB
	Full Scale Input Voltage			14		$V_{PK}$
	Differential Mode Gain	$P_{out} = 1\text{ W}$ , using a 40Hz - 40dBFS pilot tone	0.99		1.01	
	Differential Mode Gain Variability	$P_{out} = 100\text{ mW}$ to 0.1% THD+N, using a 40Hz, -40dBFS pilot tone	-0.45		+0.45	%
	Gain error over temperature	$-20^\circ\text{C}$ to $70^\circ\text{C}$ , $P_{out}=1\text{ W}$	-0.75		+0.75	%
	Offset	HPF_FREQ_REC[2:0]=0h	-10		+10	mV
	Frequency Response	20Hz - 20kHz	-0.1		0.1	dB
	Group Delay			8		$1/f_s$
<b>SPEAKER VOLTAGE to CURRENT SENSE PHASE</b>						
	Phase Error between V and I			300		ns
<b>PROTECTION CIRCUITRY</b>						
	Brownout Prevention Latency to First Attack	PWR_MODE2, Measured at BOP_TH0 of 8.25V		15		$\mu\text{s}$
	Thermal Shutdown Temperature - Typical values		135	145	155	$^\circ\text{C}$
	Output Over Current Limit on PVDD	Output to Output, Output to GND, Output to PVDD		5.9		A
	Output Overt Current Limit on VBAT1S	Output to Output, Output to GND		2.5		A
	VBAT1S Undervoltage Lockout Threshold	UVLO is asserted	2			V
		UVLO is de-asserted			2.3	
	AVDD Undervoltage Lockout Threshold	UVLO is asserted	1.4			V
		UVLO is de-asserted			1.6	
	IOVDD Undervoltage Lockout Threshold	UVLO is asserted	0.7			V
		UVLO is de-asserted			1.1	
	VBAT1S Internal LDO Undervoltage Lockout Threshold	UVLO is asserted	4			V

**TAS2764**

SLOS998A – DECEMBER 2020 – REVISED SEPTEMBER 2021

$T_A = 25\text{ }^\circ\text{C}$ ,  $PVDD = 12\text{ V}$ ,  $VBAT1S = 3.8\text{ V}$ ,  $AVDD = 1.8\text{ V}$ ,  $IOVDD = 1.2\text{ V}$ ,  $R_L = 4\Omega + 16\mu\text{H}$ ,  $f_{in} = 1\text{ kHz}$ ,  $f_s = 48\text{ kHz}$ ,  $\text{Gain} = 21\text{ dBV}$ ,  $\text{SDZ} = 1$ ,  $\text{EDGE\_RATE}[1:0]=00$ ,  $\text{NG\_EN}=0$ ,  $\text{EN\_LLSR}=1$ ,  $\text{PWR\_MODE1}$ , Measured filter free as in Section 7 (unless otherwise noted).

PARAMETER		TEST CONDITIONS	MIN	TYP	MAX	UNIT
	VBAT1S Internal LDO Overvoltage Lockout Threshold	OVLO is asserted			5.5	V

**TYPICAL CURRENT CONSUMPTION**

Hardware Shutdown	SDZ = 0, PVDD	0.1	$\mu\text{A}$
	SDZ = 0, VBAT1S	0.1	
	SDZ = 0, AVDD	1	
	SDZ = 0, IOVDD	0.1	
Software Shutdown	All Clocks Stopped, PVDD	0.1	$\mu\text{A}$
	All Clocks Stopped, VBAT1S	1	
	All Clocks Stopped, AVDD	10	
	All Clocks Stopped, IOVDD	1	
Noise Gate Mode	$f_s = 48\text{ kHz}$ , PVDD	0.05	mA
	$f_s = 48\text{ kHz}$ , VBAT1S	0.14	
	$f_s = 48\text{ kHz}$ , AVDD	3.2	
	$f_s = 48\text{ kHz}$ , IOVDD	0.1	
Idle Mode - PWR_MODE1, PWR_MODE3	$f_s = 48\text{ kHz}$ , PVDD	0.02	mA
	$f_s = 48\text{ kHz}$ , VBAT1S	3	
	$f_s = 48\text{ kHz}$ , AVDD	8.9	
	$f_s = 48\text{ kHz}$ , IOVDD	0.1	
Idle Mode - PWR_MODE2	$f_s = 48\text{ kHz}$ , PVDD	3.2	mA
	$f_s = 48\text{ kHz}$ , AVDD	9.3	
	$f_s = 48\text{ kHz}$ , IOVDD	0.1	
Idle Mode - PWR_MODE4	$f_s = 48\text{ kHz}$ , PVDD	4.1	mA
	$f_s = 48\text{ kHz}$ , AVDD	9.3	
	$f_s = 48\text{ kHz}$ , IOVDD	0.1	
Idle Mode - PWR_MODE1, PWR_MODE3	$f_s = 48\text{ kHz}$ , AVDD, IV Sense Disabled	6.3	

\* For definition of power modes see [Section 11.1](#).

## 6.6 I<sup>2</sup>C Timing Requirements

T<sub>A</sub> = 25 °C, AVDD = IOVDD = 1.8 V (unless otherwise noted)

		MIN	NOM	MAX	UNIT
<b>Standard-Mode</b>					
f <sub>SCL</sub>	SCL clock frequency	0		100	kHz
t <sub>HD,STA</sub>	Hold time (repeated) START condition. After this period, the first clock pulse is generated.	4			µs
t <sub>LOW</sub>	LOW period of the SCL clock	4.7			µs
t <sub>HIGH</sub>	HIGH period of the SCL clock	4			µs
t <sub>SU,STA</sub>	Setup time for a repeated START condition	4.7			µs
t <sub>HD,DAT</sub>	Data hold time: For I <sup>2</sup> C bus devices	0		3.45	µs
t <sub>SU,DAT</sub>	Data set-up time	250			ns
t <sub>r</sub>	SDA and SCL rise time			1000	ns
t <sub>f</sub>	SDA and SCL fall time			300	ns
t <sub>SU,STO</sub>	Set-up time for STOP condition	4			µs
t <sub>BUF</sub>	Bus free time between a STOP and START condition	4.7			µs
C <sub>b</sub>	Capacitive load for each bus line			400	pF
<b>Fast-Mode</b>					
f <sub>SCL</sub>	SCL clock frequency	0		400	kHz
t <sub>HD,STA</sub>	Hold time (repeated) START condition. After this period, the first clock pulse is generated.	0.6			µs
t <sub>LOW</sub>	LOW period of the SCL clock	1.3			µs
t <sub>HIGH</sub>	HIGH period of the SCL clock	0.6			µs
t <sub>SU,STA</sub>	Setup time for a repeated START condition	0.6			µs
t <sub>HD,DAT</sub>	Data hold time: For I <sup>2</sup> C bus devices	0		0.9	µs
t <sub>SU,DAT</sub>	Data set-up time	100			ns
t <sub>r</sub>	SDA and SCL rise time		$20 + 0.1 \times C_b[\text{pF}]$	300	ns
t <sub>f</sub>	SDA and SCL fall time		$20 + 0.1 \times C_b[\text{pF}]$	300	ns
t <sub>SU,STO</sub>	Set-up time for STOP condition	0.6			µs
t <sub>BUF</sub>	Bus free time between a STOP and START condition	1.3			µs
C <sub>b</sub>	Capacitive load for each bus line (10pF to 400pF)			400	pF
<b>Fast-Mode Plus</b>					
f <sub>SCL</sub>	SCL clock frequency	0		1000	kHz
t <sub>HD,STA</sub>	Hold time (repeated) START condition. After this period, the first clock pulse is generated.	0.26			µs
t <sub>LOW</sub>	LOW period of the SCL clock	0.5			µs
t <sub>HIGH</sub>	HIGH period of the SCL clock	0.26			µs
t <sub>SU,STA</sub>	Setup time for a repeated START condition	0.26			µs
t <sub>HD,DAT</sub>	Data hold time: For I <sup>2</sup> C bus devices	0			µs
t <sub>SU,DAT</sub>	Data set-up time	50			ns
t <sub>r</sub>	SDA and SCL Rise Time			120	ns
t <sub>f</sub>	SDA and SCL Fall Time			120	ns
t <sub>SU,STO</sub>	Set-up time for STOP condition				µs
t <sub>BUF</sub>	Bus free time between a STOP and START condition	0.5			µs
C <sub>b</sub>	Capacitive load for each bus line			550	pF

### 6.7 TDM Port Timing Requirements

T<sub>A</sub> = 25 °C, AVDD = IOVDD = 1.8 V, 20 pF load on all outputs(unless otherwise noted)

			MIN	NOM	MAX	UNIT
t <sub>H</sub> (SBCLK)	SBCLK high period		20			ns
t <sub>L</sub> (SBCLK)	SBCLK low period		20			ns
t <sub>SU</sub> (FSYNC)	FSYNC setup time		8			ns
t <sub>HLD</sub> (FSYNC)	FSYNC hold time		8			ns
t <sub>SU</sub> (SDIN/ICC)	SDIN/ICC setup time		8			ns
t <sub>HLD</sub> (SDIN/ICC)	SDIN/ICC hold time		8			ns
t <sub>d</sub> (SBCLK_SDOU/ICC)	SBCLK to SDOU/ICC delay	50% of SBCLK to 50% of SDOU/ICC, IOVDD=1.8V	2.8		13	ns
		50% of SBCLK to 50% of SDOU/ICC, IOVDD=1.2V	3.6		17	
t <sub>r</sub> (SBCLK)	SBCLK rise time	10% - 90% Rise Time			8	ns
t <sub>f</sub> (SBCLK)	SBCLK fall time	90% - 10% Fall Time			8	ns

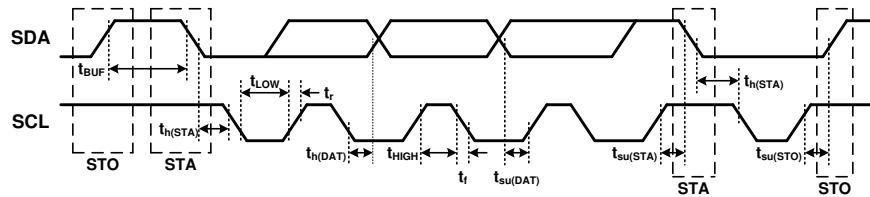


Figure 6-1. I2C Timing Diagram

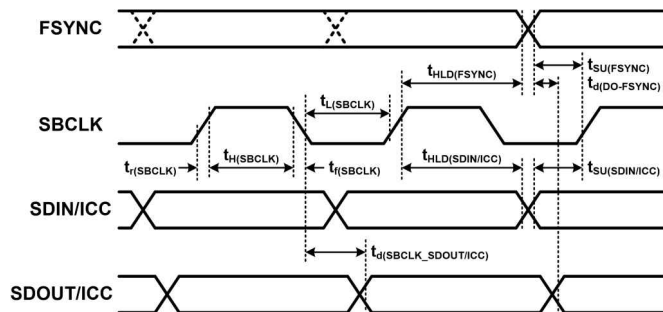


Figure 6-2. TDM and ICC Timing Diagram

## 6.8 Typical Characteristics

$T_A = 25\text{ }^\circ\text{C}$ , PWR\_MODE1,  $f_{\text{SPK\_AMP}} = 384\text{ kHz}$ , input signal  $f_{\text{IN}} = 1\text{ kHz}$  - Sine, filter for load resistance  $15\text{ }\mu\text{H}$ , unless otherwise noted.

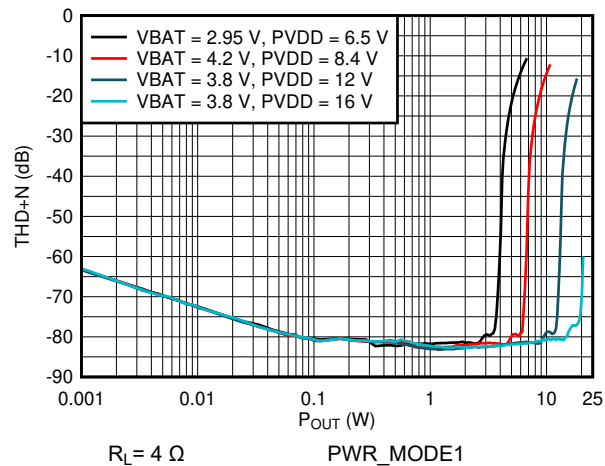


Figure 6-3. THD+N vs Output Power

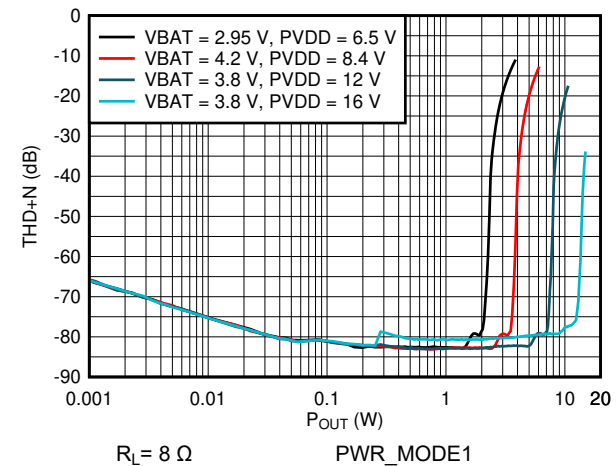


Figure 6-4. THD+N vs Output Power

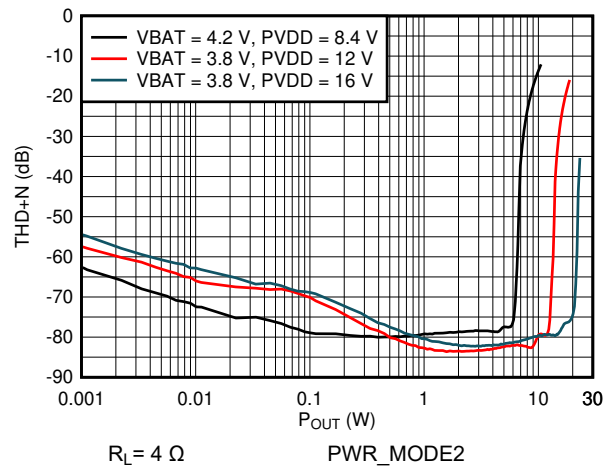


Figure 6-5. THD+N vs Output Power

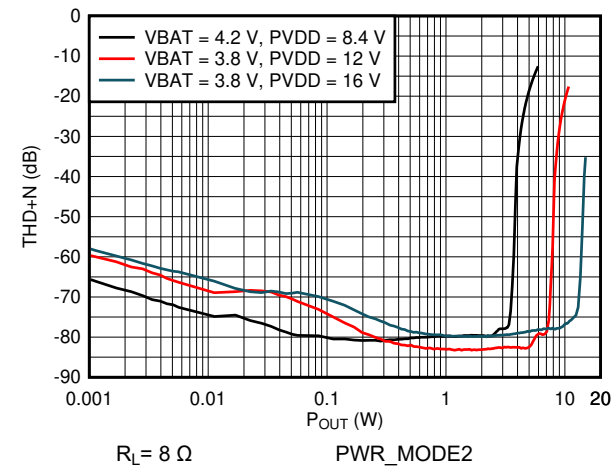


Figure 6-6. THD+N vs Output Power

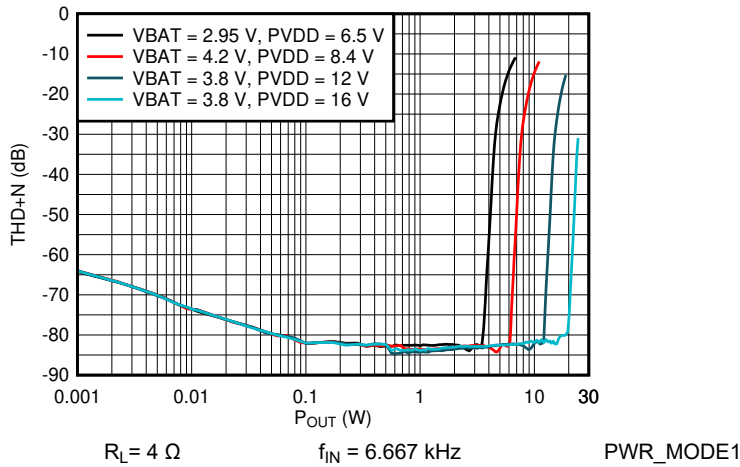


Figure 6-7. THDN vs Output Power

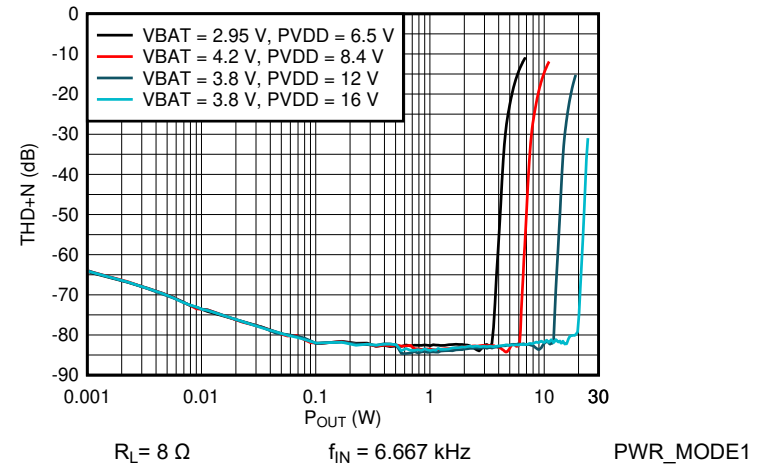


Figure 6-8. THDN vs Output Power

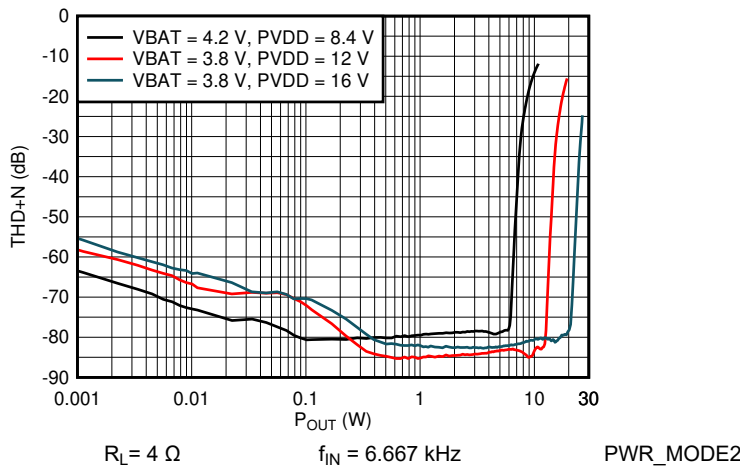


Figure 6-9. THDN vs Output Power

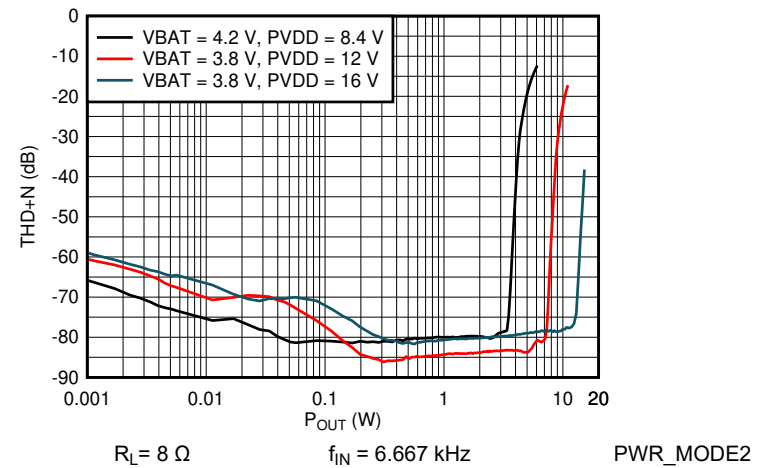
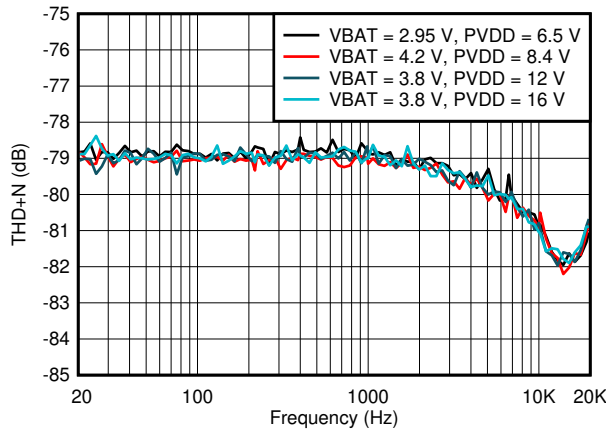
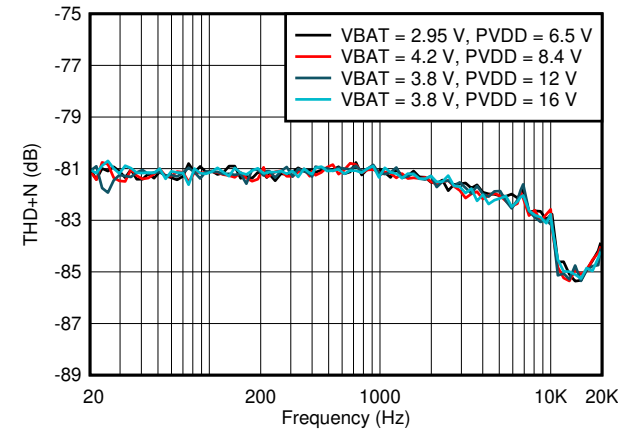


Figure 6-10. THDN vs Output Power



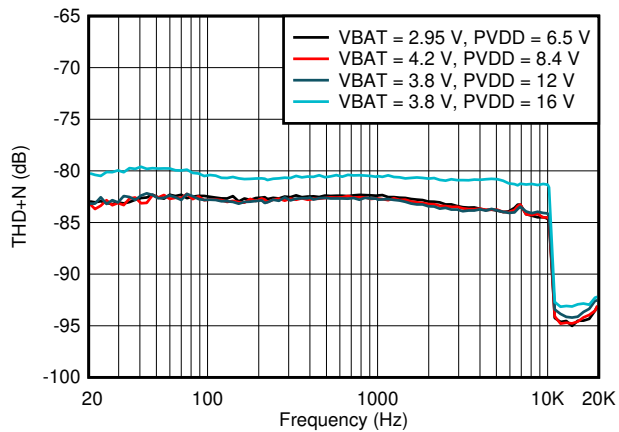
$R_L = 4 \Omega$        $P_{OUT} = 0.1 \text{ W}$

**Figure 6-11. THDN vs Frequency**



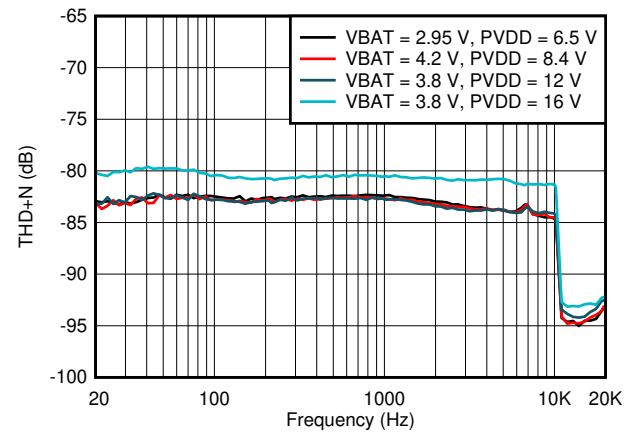
$R_L = 8 \Omega$        $P_{OUT} = 0.1 \text{ W}$

**Figure 6-12. THDN vs Frequency**



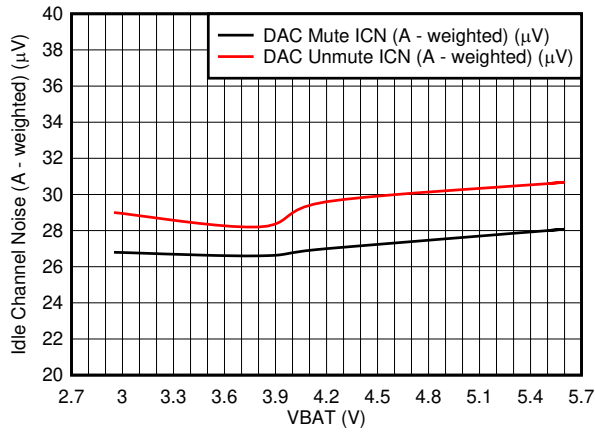
$R_L = 4 \Omega$        $P_{OUT} = 1 \text{ W}$

**Figure 6-13. THDN vs Frequency**



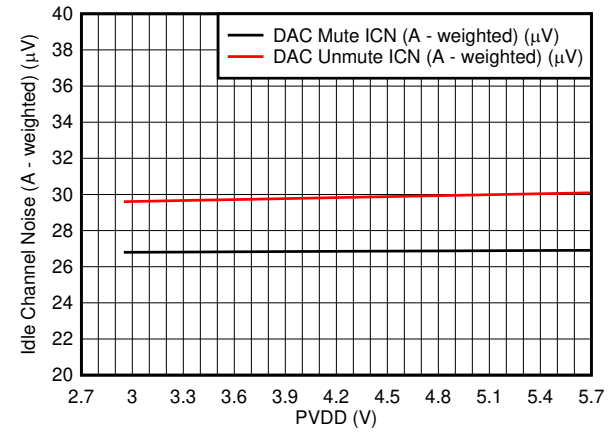
$R_L = 8 \Omega$        $P_{OUT} = 1 \text{ W}$

**Figure 6-14. Class D THDN vs Frequency**



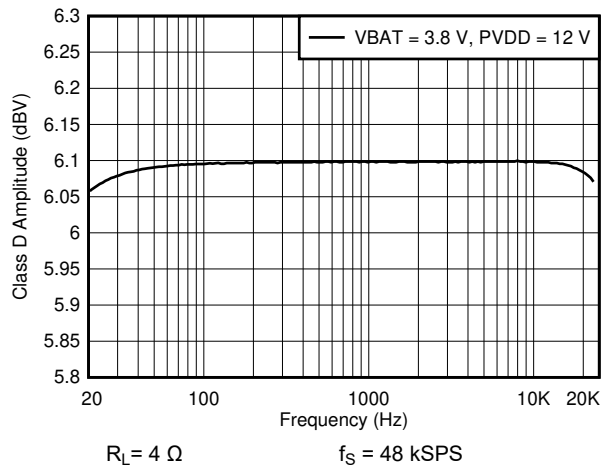
PWR\_MODE1

**Figure 6-15. ICN (A Weighted) vs VBAT**

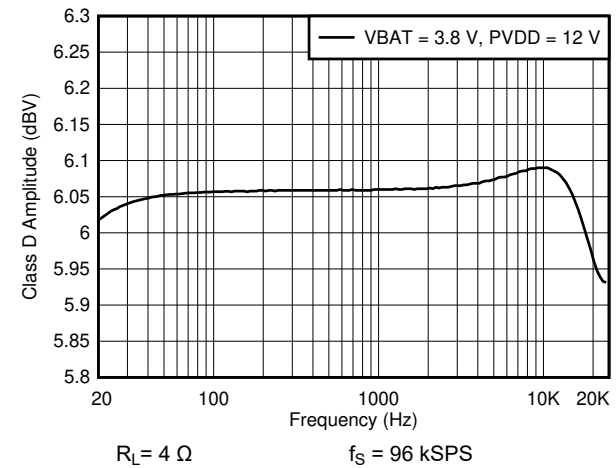


PWR\_MODE2

**Figure 6-16. ICN (A-Weighted) vs PVDD**

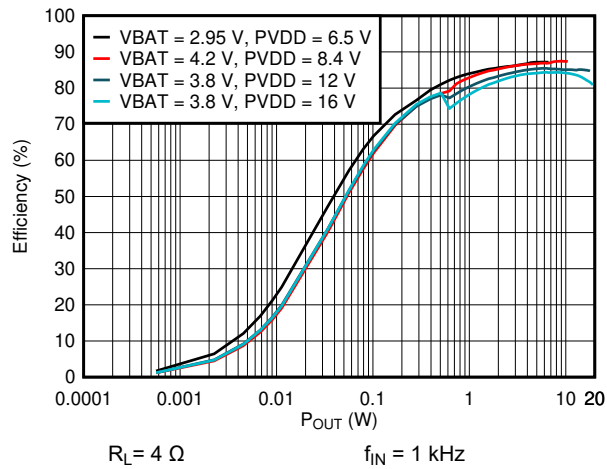


**Figure 6-17. Class D Frequency Response**

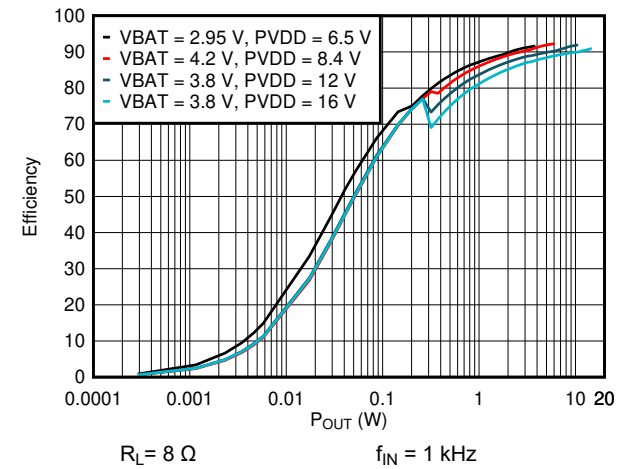


**Figure 6-18. Class D Frequency Response**

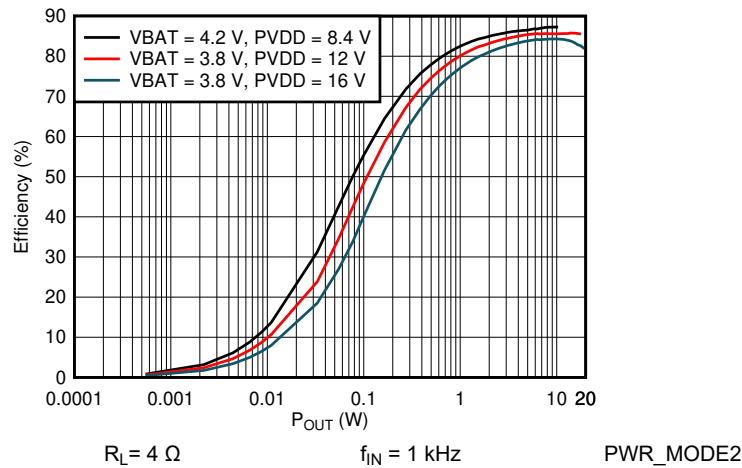




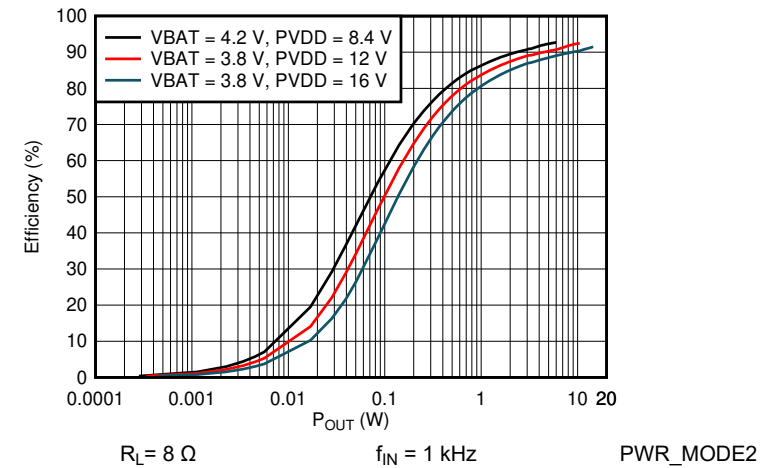
**Figure 6-19. Efficiency vs Output Power**



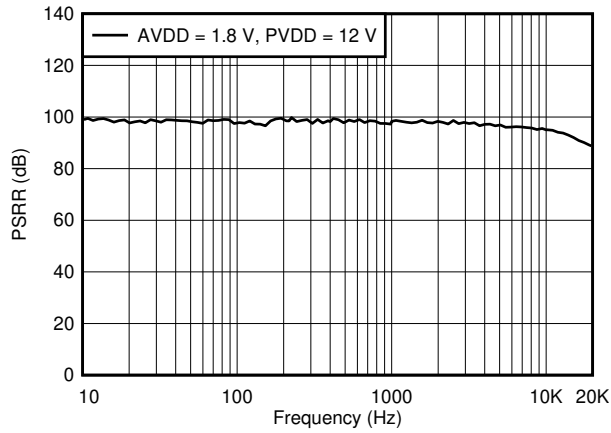
**Figure 6-20. Efficiency vs Output Power**



**Figure 6-21. Efficiency vs Output Power**

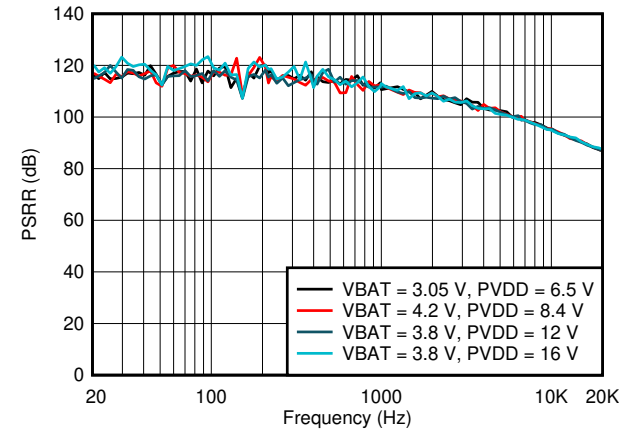


**Figure 6-22. Efficiency vs Output Power**



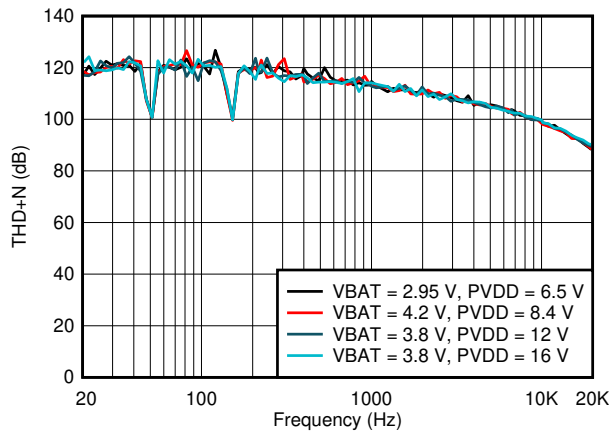
$R_L = 4 \Omega$

**Figure 6-23. AVDD PSRR vs Frequency**



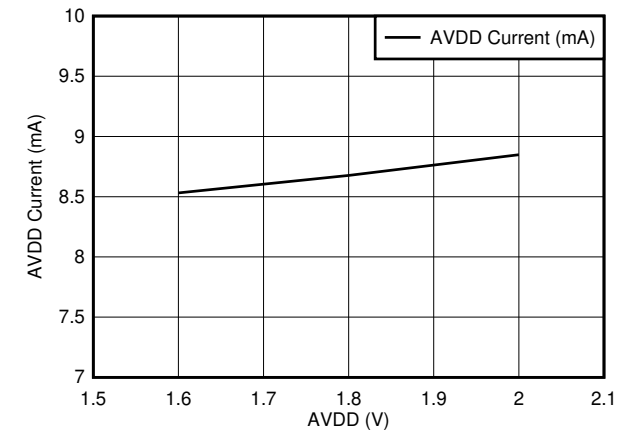
$R_L = 4 \Omega$

**Figure 6-24. VBAT PSRR vs Frequency**



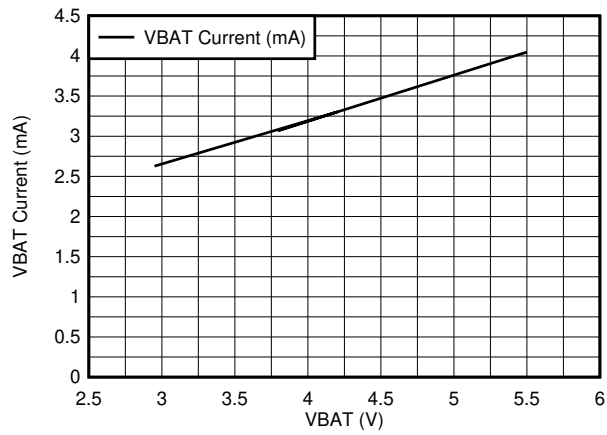
$R_L = 4 \Omega$

**Figure 6-25. PVDD PSRR vs Frequency**



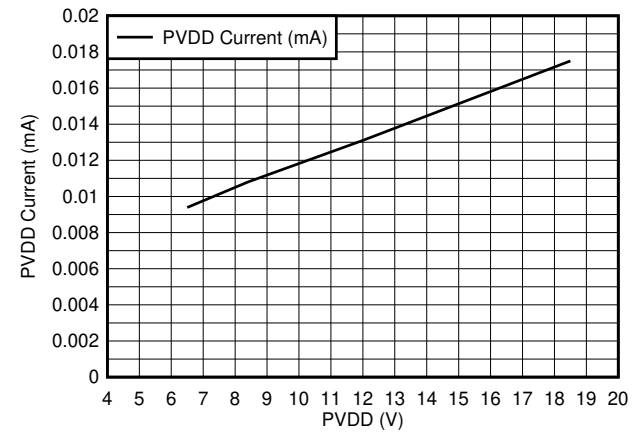
IV Sense Enabled

**Figure 6-26. AVDD Idle Current vs AVDD**



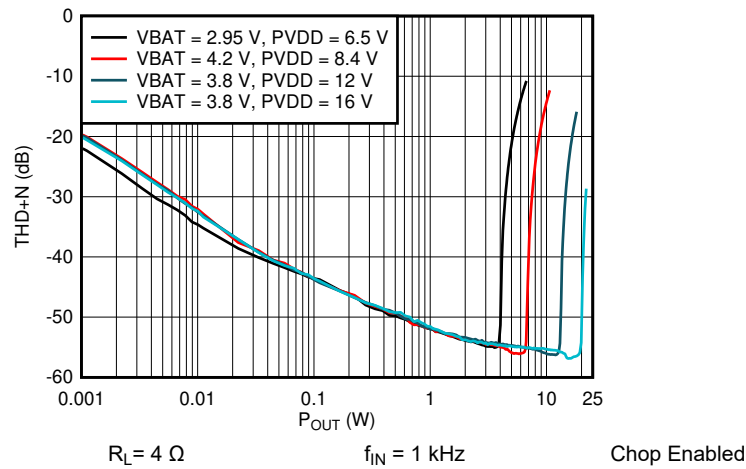
IV Sense Enabled

**Figure 6-27. VBAT Idle Current vs VBAT**

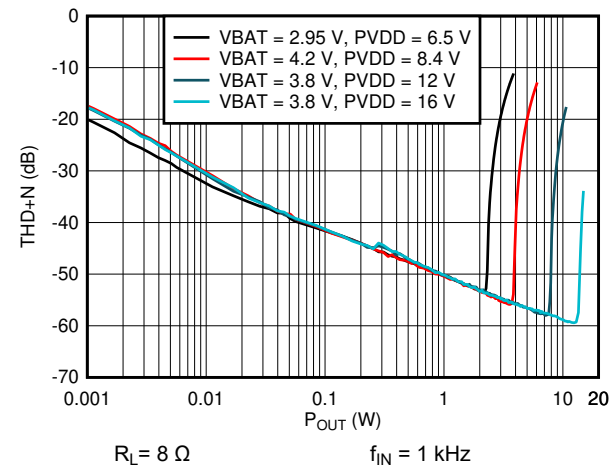


IV Sense Enabled

**Figure 6-28. PVDD Idle Current vs PVDD**



**Figure 6-29. I Sense THDN vs Output Power**



**Figure 6-30. I Sense THDN vs Output Power**

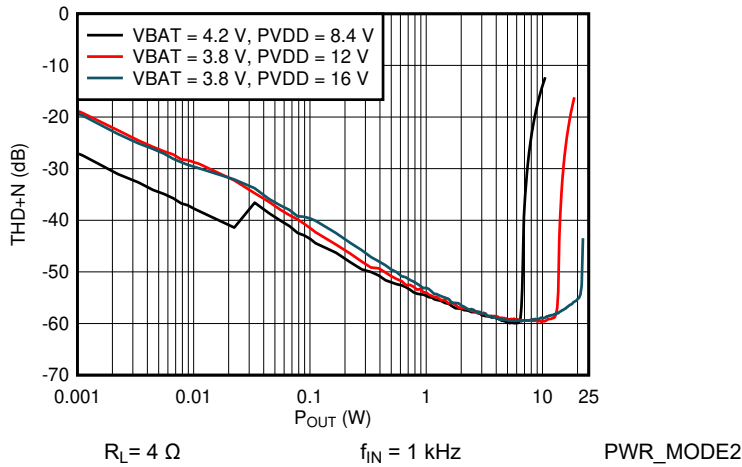


Figure 6-31. I Sense THDN vs Output Power

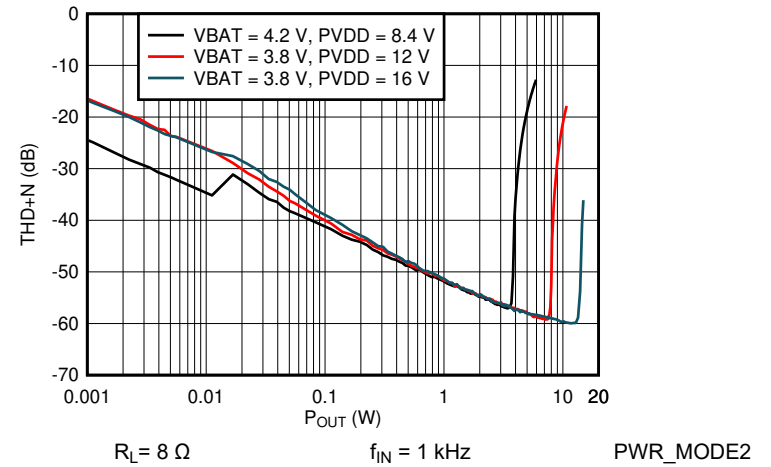


Figure 6-32. I Sense THDN vs Output Power

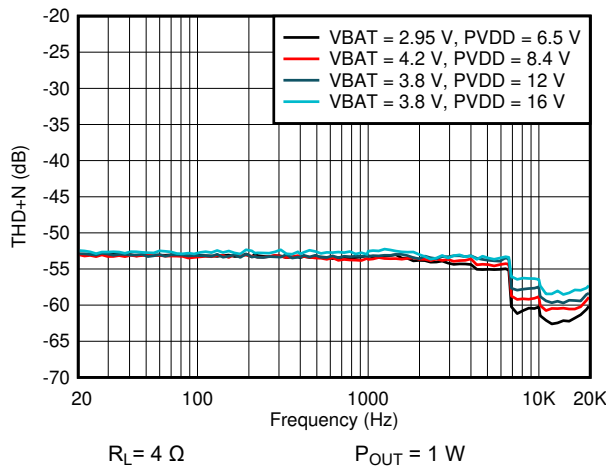


Figure 6-33. I Sense THDN vs Frequency

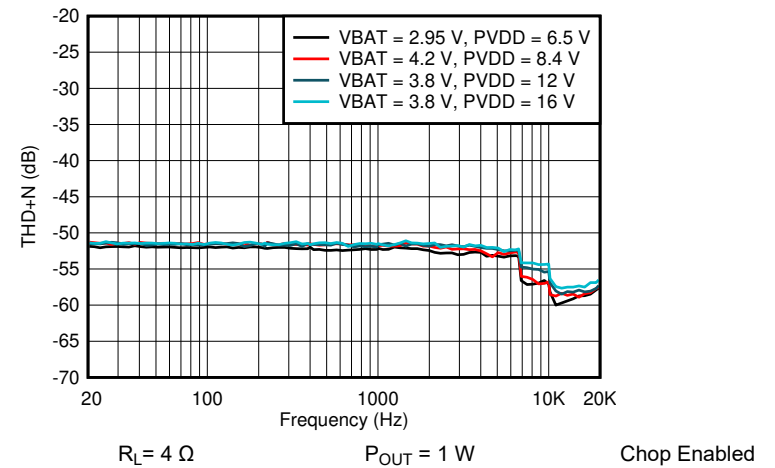
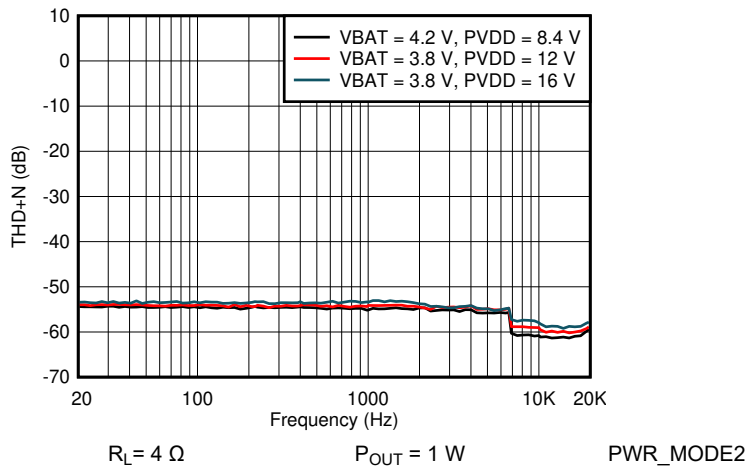
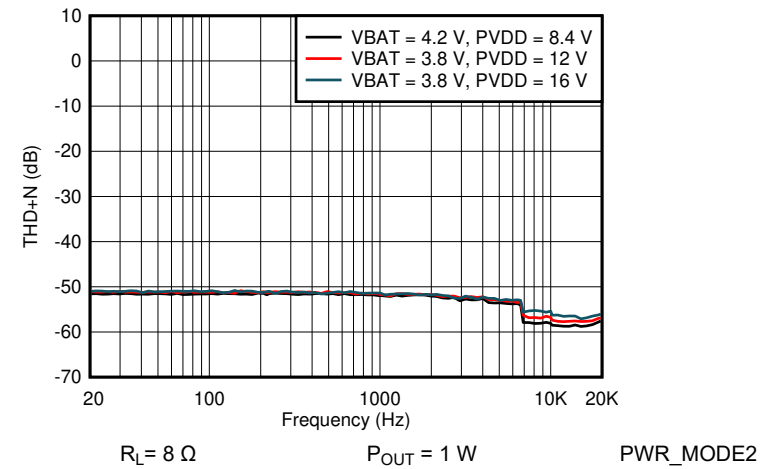


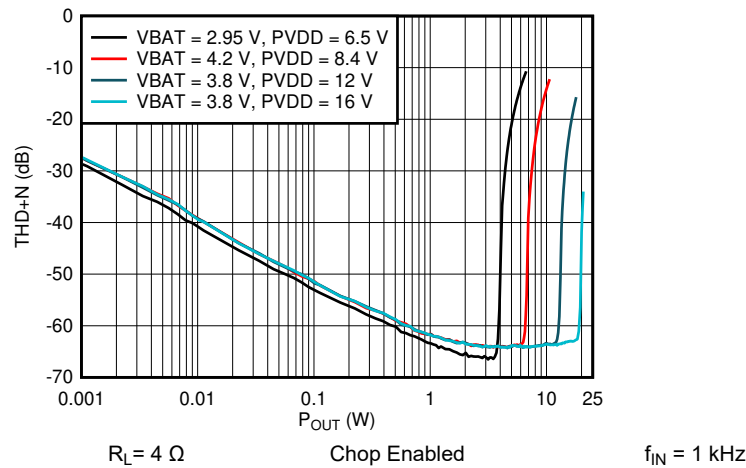
Figure 6-34. I Sense THDN vs Frequency



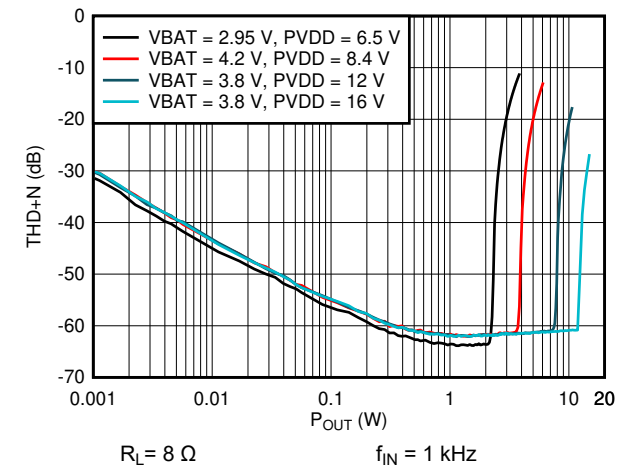
**Figure 6-35. I Sense THDN vs Frequency**



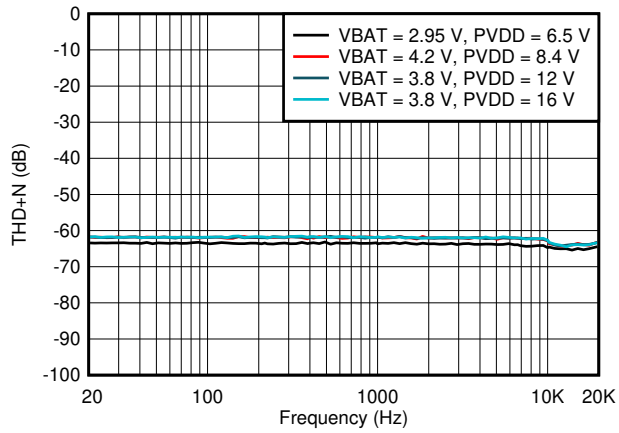
**Figure 6-36. I Sense THD vs. Frequency**



**Figure 6-37. V Sense THDN vs Pout**



**Figure 6-38. V Sense THDN vs Pout**

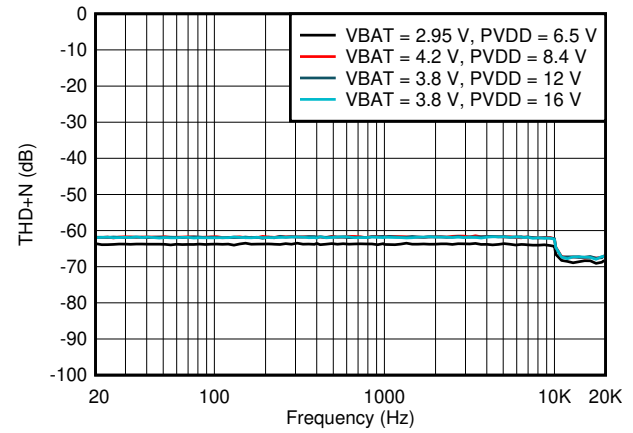


$R_L = 4 \Omega$

Chop Enabled

$P_{OUT} = 1 W$

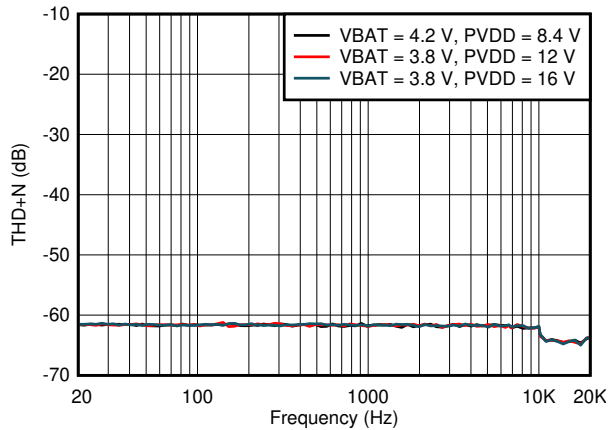
**Figure 6-39. V Sense THDN vs Frequency**



$R_L = 8 \Omega$

$P_{OUT} = 1 W$

**Figure 6-40. V Sense THDN vs Frequency**

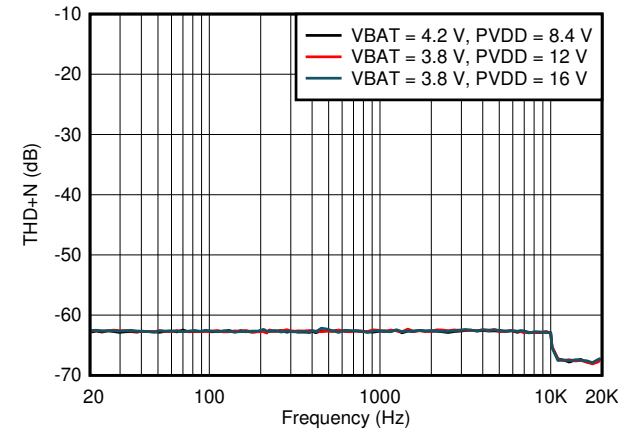


$R_L = 4 \Omega$

$P_{OUT} = 1 W$

PWR\_MODE2

**Figure 6-41. V Sense THDN vs Frequency**



$R_L = 8 \Omega$

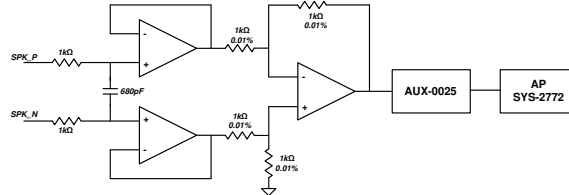
$P_{OUT} = 1 W$

PWR\_MODE2

**Figure 6-42. V Sense THDN vs Frequency**

## 7 Parameter Measurement Information

All typical characteristics for the devices are measured using the Bench Evaluation Module (EVM) and an Audio Precision SYS-2722 Audio Analyzer. A PSIA interface is used to allow the I<sup>2</sup>S interface to be driven directly into the SYS-2722. Speaker output terminals are connected to the Audio Precision Analyzer analog inputs through a differential-to-single ended (D2S) filter as shown below. The D2S filter contains a first order passive pole at 120 kHz. The D2S filter ensures the TAS2764 high performance class-D amplifier sees a fully differential matched loading at its outputs and the output signal is single ended.



**Figure 7-1. Differential To Single Ended (D2S) Filter**

Alternatively, the AUX-0025 filter can be connected directly to the class-D outputs.

## 8 Detailed Description

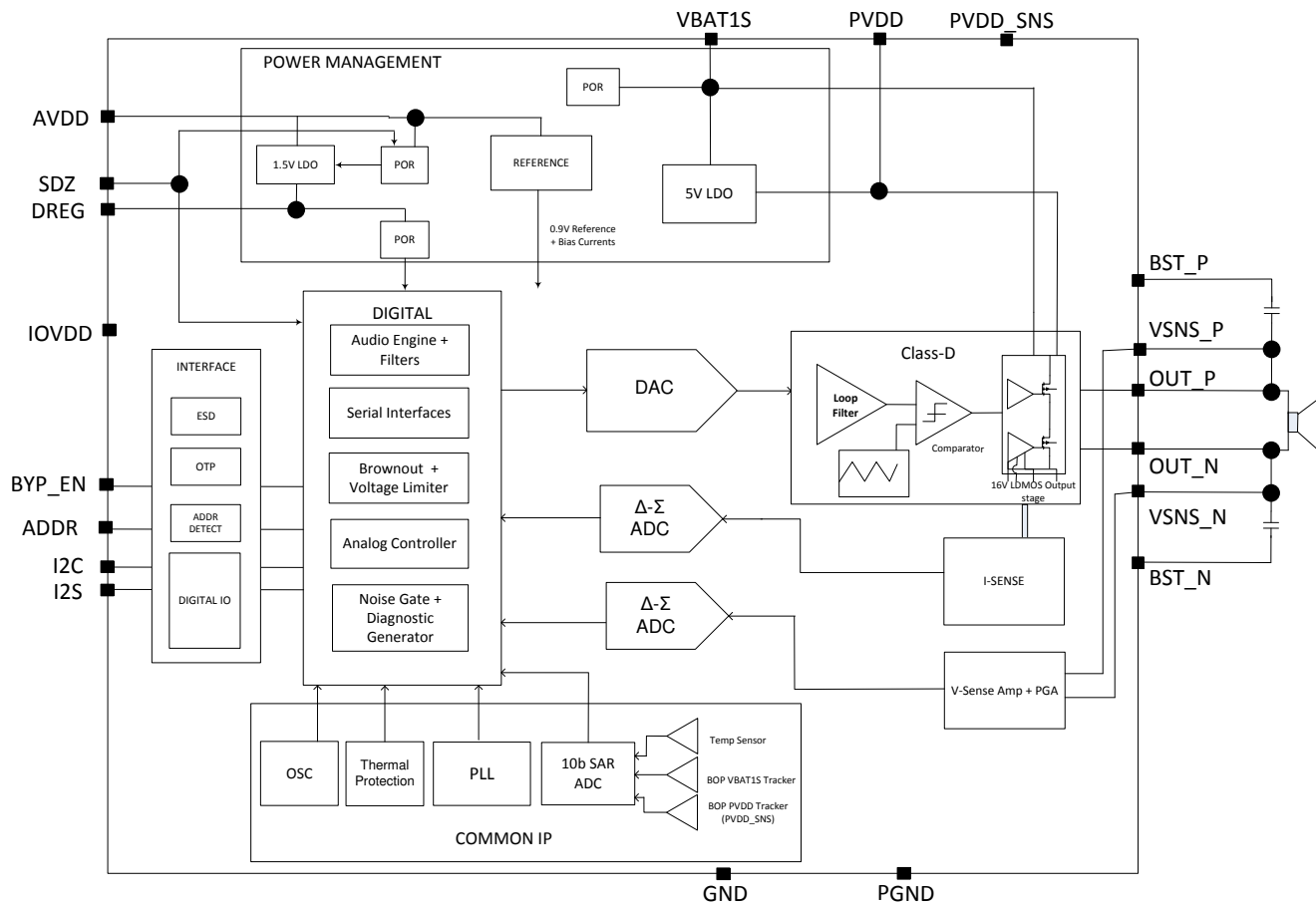
### 8.1 Overview

The TAS2764 is a mono digital input Class-D amplifier optimized for portable applications where efficient battery operation and small solution size are critical. It integrates speaker IV (current/voltage) sensing and battery tracking limiting with brown out prevention. The device operates using a TDM/I<sup>2</sup>S and I<sup>2</sup>C interfaces.

**Table 8-1. Full Scales**

Input/Output Signal	Full Scale Value
Class-D Output	21 dBV
Voltage Monitor	PVDD: 16 V
	VBAT1S: 6V
Current Sense	3.75 Apk
Voltage Sense	14 Vpk

### 8.2 Functional Block Diagram



### 8.3 Feature Description

#### 8.3.1 Device Address Selection

The TAS2764 operates using a TDM/I<sup>2</sup>S interface. Audio input and output are provided via the FSYNC, SBCLK, SDIN and SDOOUT pins using formats including I<sup>2</sup>S, Left Justified and TDM. Configuration and status are provided via the SDA and SCL pins using the I<sup>2</sup>C protocol.

The table below illustrates how to configure the device for I<sup>2</sup>C address. The slave addresses are shown left shifted by one bit with the R/W bit set to 0 (i.e. {ADDR[6:0],1b0}). Resistors with tolerance better than 5% must be used for setting the address configuration.



**Table 8-2. I<sup>2</sup>C Address Selection**

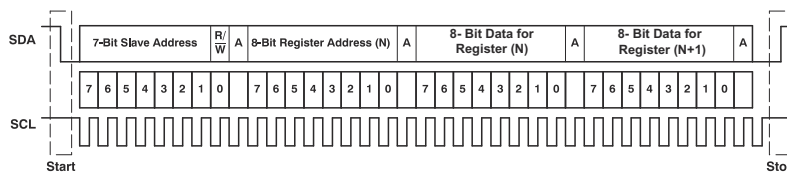
I <sup>2</sup> C SLAVE ADDRESS	0x70	0x72	0x74	0x76	0x78	0x7A	0x7C	0x7E
ADDR PIN	Short to GND	470 Ω to GND	470 Ω to AVDD	2.2k Ω to GND	2.2k Ω to AVDD	10 kΩ to GND	10 kΩ to AVDD	Short to AVDD

The TAS2764 has a global 7-bit I<sup>2</sup>C address 0x80. When enabled, the device will additionally respond to I<sup>2</sup>C commands at this address regardless of the ADDR pin settings. This is used to speed up device configuration when using multiple TAS2764 devices and programming similar settings across all devices. The I<sup>2</sup>C ACK / NACK cannot be used during the multi-device writes since multiple devices are responding to the I<sup>2</sup>C command. The I<sup>2</sup>C CRC function should be used to ensure each device properly received the I<sup>2</sup>C commands. At the completion of writing multiple devices using the global address, the CRC at *I2C\_CKSUM* register should be checked on each device using the local address for a proper value. The global I<sup>2</sup>C address can be disabled using *I2C\_GBL\_EN* register bit. The I<sup>2</sup>C address is detected by sampling the ADDR pin when SDZ pin is released. Additionally, the address may be re-detected by setting *I2C\_AD\_DET* register bit high after power up and the ADDR pin will be re-sampled.

### 8.3.2 General I<sup>2</sup>C Operation

The I<sup>2</sup>C bus employs two signals, SDA (data) and SCL (clock), to communicate between integrated circuits in a system using serial data transmission. The address and 8 bit data are transferred starting with the most-significant bit (MSB). In addition, each byte transferred on the bus is acknowledged by the receiving device with an acknowledge bit. Each transfer operation begins with the master device driving a start condition on the bus and ends with the master device driving a stop condition on the bus. The bus uses transitions on the data terminal (SDA) while the clock is at logic high to indicate start and stop conditions. A high-to-low transition on SDA indicates a start, and a low-to-high transition indicates a stop. Normal data-bit transitions must occur within the low time of the clock period.

The master generates the 7-bit slave address and the read/write (R/W) bit to open communication with another device and then waits for an acknowledge condition. The device holds SDA low during the acknowledge clock period to indicate acknowledgment. When this occurs, the master transmits the next byte of the sequence. Each device is addressed by a unique 7-bit slave address plus R/W bit (1 byte). All compatible devices share the same signals via a bi-directional bus using a wired-AND connection.



**Figure 8-1. Typical I<sup>2</sup>C Sequence**

There is no limit on the number of bytes that can be transmitted between start and stop conditions. When the last word transfers, the master generates a stop condition to release the bus. Figure 8-1 shows a generic data transfer sequence.

For information about pull-up resistors and single-byte/multiple-byte transfers see .

### 8.3.3 Register Organization

Device configuration and coefficients are stored using a page and book scheme. Each page contains 128 bytes and each book contains 256 pages. All device configuration registers are stored in book 0, page 0, which is the default setting at power up (and after a software reset). The book and page can be set by the *BOOK* and *PAGE* registers respectively.

### Note

Programming register bits from Book\_0 and Page\_4 needs to be done in groups of four registers (32 bit format), each byte corresponding to a register and with less significant byte programmed to 00h. For instance, when programming DC level for diagnostic generator, registers 08 (MSB),09,0A will be programmed to the desired value and register 0B will be programmed to 00h.

## 8.4 Device Functional Modes

### 8.4.1 TDM Port

The TAS2764 provides a flexible TDM serial audio port. The port can be configured to support a variety of formats including stereo I<sup>2</sup>S, Left Justified and TDM. Mono audio playback is available via the SDIN pin. The SDOOUT pin is used to transmit sample streams including speaker voltage and current sense, PVDD voltage, die temperature and channel gain.

The TDM serial audio port supports up to 16 of 32-bit time slots at 44.1/48 kHz or 8 of 32-bit time slots at a 88.2/96 kHz sample rate. Valid SBCLK to FSYNC ratios are 16, 24, 32, 48, 64, 96, 128, 192, 256, and 512. The device will automatically detect the number of time slots and it does not need to be programmed.

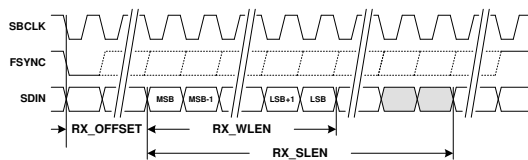
By default, the TAS2764 will automatically detect the PCM playback sample rate. This can be disabled and manually configured by setting the *AUTO\_RATE* register bit high.

The *SAMP\_RATE[2:0]* and *SAMP\_RATIO[3:0]* register bits are used to configure the PCM audio sample rate when *AUTO\_RATE* register bit is high (auto detection of TDM sample rate is disabled). The TAS2764 employs a robust clock fault detection engine that will automatically volume ramp down the playback path if FSYNC does not match the configured sample rate (if *AUTO\_RATE* = 1) or the ratio of SBCLK to FSYNC is not supported (minimizing any audible artifacts). Once the clocks are detected to be valid in both frequency and ratio, the device will automatically volume ramp the playback path back to the configured volume and resume playback.

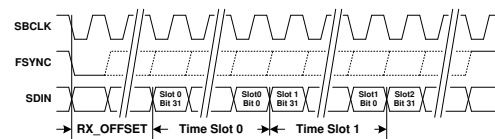
When using the auto rate detection the sampling rate and SBCLK to FSYNC ration detected on the TDM bus is reported back on the read-only register bits *FS\_RATE[2:0]* and *FS\_RATIO[3:0]* respectively.

The TAS2764 supports a 12 MHz SBCLK operation. The system will detect or should be manually configured for a ratio of 125 or 250. In this specific ratio the last 32-bit slot should not be used to transmit data over the TDM port (Section 8.4.1) or ICC pin (Section 8.4.2.9.1) as data will be truncated.

Figure 8-2 and Figure 8-3 below illustrate the receiver frame parameters required to configure the port for playback. A frame begins with the transition of FSYNC from either high to low or low to high (set by the *FRAME\_START* register bit). FSYNC and SDIN are sampled by SBCLK using either the rising or falling edge (set by the *RX\_EDGE* register bit). The *RX\_OFFSET[4:0]* register bits define the number of SBCLK cycles from the transition of FSYNC until the beginning of time slot 0. This is typically set to a value of 0 for Left Justified format and 1 for an I<sup>2</sup>S format.



**Figure 8-2. TDM RX Time Slot with Left Justification**



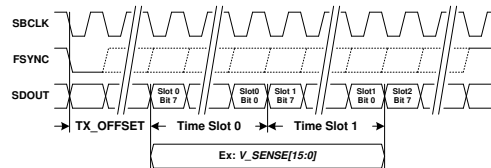
**Figure 8-3. TDM RX Time Slots**

The *RX\_SLEN[1:0]* register bits set the length of the RX time slot to 16, 24 or 32 (default) bits. The length of the audio sample word within the time slot is configured by the *RX\_WLEN[1:0]* register bits to 16, 20, 24 (default) or 32 bits. The RX port will left justify the audio sample within the time slot by default, but this can be changed to right justification via the *RX\_JUSTIFY* register bit. The TAS2764 supports mono and stereo down mix playback ( $[(L+R)/2]$ ). By default the device will playback mono from the time slot equal to the I<sup>2</sup>C base address offset (set by

the ADDR pin) for playback. The `RX_SCFG[1:0]` register bits can be used to override the playback source to the left time slot, right time slot or stereo down mix set by the `RX_SLOT_L[3:0]` and `RX_SLOT_R[3:0]` register bits.

If time slot selection places reception either partially or fully beyond the frame boundary, the receiver will return a null sample equivalent to a digitally muted sample.

The TDM port can transmit a number of sample streams on the SDOUT pin including speaker voltage sense, speaker current sense, interrupts and status, PVDD voltage, die temperature and channel gain. Figure 8-4 below illustrates the alignment of time slots to the beginning of a frame and how a given sample stream is mapped to time slots.



**Figure 8-4. TDM Port TX Diagram**

Either the rising or falling edge of SBCLK can be used to transmit data on the SDOUT pin. This can be configured by setting the `TX_EDGE` register bit. The `TX_OFFSET[2:0]` register bits define the number SBCLK cycles between the start of a frame and the beginning of time slot 0. This would typically be programmed to 0 for Left Justified format and 1 for I<sup>2</sup>S format. The TDM and ICC TX can either transmit logic 0 or Hi-Z depending on the setting of the `TX_FILL` register bit. An optional bus keeper will weakly hold the state of SDOUT and ICC pins when all devices driving are Hi-Z. Since only one bus keeper is required on SDOUT, this feature can be disabled via the `TX_KEEPCY` register bit. The bus keeper can be configured to hold only 1LSB or Always using `TX_KEEPEN` register bit. Additionally, the keeper LSB can be driven for a full cycle or half of cycle using `TX_KEEPCY` register bit.

`TX_FILL` is used in mono system where there is only one amplifier on I<sup>2</sup>S bus. All the slots unused by the amplifier will be filled with zeros when `TX_FILL` is set to low.

The `SDOUT_HIZ` registers from page 0x01 are useful when multiple devices are on the same I<sup>2</sup>S bus. Each device does not know configuration of slots in the other devices on the bus. It is required at the system level to program the `SDOUT_HIZ` registers appropriately, in such way that the settings are done correctly and do not create any contention both internally and externally.

Each sample stream is composed of either one or two 8-bit time slots. Speaker voltage sense and speaker current sense sample streams are 16-bit precision, so they will always utilize two TX time slots. The PVDD voltage stream is 12 bit precision, and can either be transmitted left justified in a 16-bit word (using two time slots) or can be truncated to 8-bits (the top 8 MSBs) and be transmitted in a single time slot. This is configured by setting `PVDD_SLEN` register bit. The Die temperature and gain are both 8-bit precision and are transmitted in a single time slot.

The time slot register for each sample stream defines where the MSB transmission begins. For instance, if `VSNS_SLOT[5:0]` register bits are set to 2 (decimal), the upper 8 MSBs will be transmitted in time slot 2 and the lower 8 LSBs will be transmitted in time slot 3. Each sample stream can be individually enabled or disabled by using `VSNS_TX` and `ISNS_TX` register bits. This is useful to manage limited TDM bandwidth since it may not be necessary to transmit all streams for all devices on the bus.

It is important to ensure that time slot assignments for actively transmitted sample streams do not conflict. For instance, if `VSNS_SLOT[5:0]` bits are set to 2 (decimal) and `ISNS_SLOT[5:0]` bits are set to 3 (decimal), the lower 8 LSBs of voltage sense will conflict with the upper 8 MSBs of current sense. This will produce unpredictable transmission results in the conflicting bit slots (i.e. the priority is not defined).

When two or more devices are connected to the same SDOUT pin the slot assignment of the various devices must be kept exclusive to avoid any contention. This constraint is applicable to both Software Shutdown and Active Mode. Devices should not be programmed to transmit on the same slot.

The current and voltage values are transmitted at the full 16-bit measured values by default. The *IVMON\_LEN[1:0]* register bits can be used to transmit only the 8 MSB bits in one slot or 12 MSB bits values across multiple slots. The special 12-bit mode is used when only 24-bit I2S/TDM data can be processed by the host processor. The device should be configured with the voltage-sense slot and current-sense slot off by 1 slot and will consume 3 consecutive 8-bit slots. In this mode the device will transmit the first 12 MSB bits followed by the second 12 MSB bits specified by the preceding slot.

If time slot selections place transmission beyond the frame boundary, the transmitter will truncate transmission at the frame boundary.

The time slots for VBAT1S, PVDD and TEMP measurements are set using *VBAT1S\_SLOT[5:0]*, *PVDD\_SLOT[5:0]* and *TEMP\_SLOT[5:0]* register bits. To enable sample stream register bits *VBAT1S\_TX*, *PVDD\_TX* and *TEMP\_TX* must be set high. The slot length is selected by *VBAT1S\_SLEN*, *PVDD\_SLEN* and *TEMP\_SLEN* register bits.

To set TDM final processed audio slot, enable and length register bits the following register bits need to be programmed: *AUDIO\_SLOT[5:0]*, *AUDIO\_TX* and *AUDIO\_SLEN*.

Information about status of slots can be find in *STATUS\_SLOT[5:0]* register bits. *STATUS\_TX* register bit set high enables the status transmit.

The slot configuration for the TX limiter gain reduction can be set between 0 (default) and 63 by setting *GAIN\_SLOT[5:0]* register bits. It is used for the Inter Chip Gain Aligment ( [Section 8.4.2.9](#) ) and can be either over the TDM Bus or ICC pin ( [Section 8.4.2.9.1](#) ). To use this feature, the register bit *GAIN\_TX* needs to be set high (Enable).

## 8.4.2 Playback Signal Path

### 8.4.2.1 High Pass Filter

Excessive DC and low frequency content in audio playback signal can damage loudspeakers. The TAS2764 employs a high-pass filter (HPF) to prevent this from occurring for the PCM playback path. The *HPF\_FREQ\_PB[2:0]* register bits set the corner frequencies of HPF. The filter can be bypassed by setting the register bits to 3'b000.

### 8.4.2.2 Amplifier Inversion

The device will output a non-inverted signal to the OUT\_P and OUT\_N pins. The output can be inverted with respect to the digital input value by setting the *AMP\_INV* register bit to high.

### 8.4.2.3 Digital Volume Control and Amplifier Output Level

The gain from audio input to speaker terminals is controlled by setting the amplifier's output level and digital volume control (DVC).

Amplifier output level settings are programmed using *AMP\_LEVEL[4:0]* register bits. The levels are presented in the Register Map in dBV (dB relative to 1 V<sub>rms</sub>), with a full scale digital audio input (0 dBFS) and the DVC set by default to 0 dB. It should be noted that these levels may not be achievable because of analog clipping in the amplifier, so they should be used to convey gain only.

Equation 1 below calculates amplifier output voltage:

$$V_{AMP} = INPUT + A_{DVC} + A_{AMP}$$

(1)

where

- $V_{AMP}$  is the amplifier output voltage in dBV
- $INPUT$  is the digital input amplitude as a number of dB with respect to 0 dBFS
- $A_{DVC}$  is the digital volume control setting as a number of dB
- $A_{AMP}$  is the amplifier output level setting as a number of dBV

The digital volume control (DVC) is configurable from 0 dB to -100 dB in 0.5 dB steps by setting the *DVC\_LVL[7:0]* register bits. Settings greater than C8h are interpreted as mute. When a change in digital volume control occurs, the device ramps the volume to the new setting based on the *DVC\_RAMP\_RATE[1:0]* register bits status. If *DVC\_RAMP\_RATE[1:0]* bits are set to 2'b11 the volume ramping is disabled. This setting can be used to speed up startup, shutdown and digital volume changes when volume ramping is handled by the system master.

The Class-D amplifier uses a closed-loop architecture, so the gain does not depend on power supply. The approximate threshold for the onset of analog clipping is calculated in Equation 2.

$$V_{PK} = V_{SUP} * \frac{R_L}{R_{FET} + R_P + R_L} \quad (2)$$

where

- $V_{PK}$  is the maximum peak un-clipped output voltage in V
- $V_{SUP}$  is the power supply of class-D output stage
- $R_L$  is the speaker load in  $\Omega$
- $R_P$  is the parasitic resistance on PCB (routing, filters) in  $\Omega$
- $R_{FET}$  is the power stage total resistance (HS FET, LS FET, Sense Resistor, bonding, packaging) in  $\Omega$

When VBAT1S supplies class-D output stage typical  $R_{FET}$  value is 1  $\Omega$ . For PVDD supply  $R_{FET}$  typical value is 0.5  $\Omega$ .

#### 8.4.2.3.1 Safe Mode

The safe mode is a single bit that will enable 18 dB attenuation in the forward path. It is similar to setting the *DVC\_LVL[7:0]* register bits to a setting of 24h (-18dB). When the *SMODE\_EN* bit is set to high, the *DVC\_LVL[7:0]* register bits will be ignored and volume ramping disabled.

#### 8.4.2.4 VBAT1S Supply

The TAS2764 can operate with or without a VBAT1S supply. When configured without a VBAT1S supply, the PVDD voltage will be used with an internal LDO to generate this supply voltage. A decoupling capacitor should still be populated as recommended in [Table 9-1](#). In this case, *VBAT1S\_MODE* bit should be set to high before transitioning from software shutdown. More details about VBAT1S supply modes of operation can be found in [Section 11.1](#).

#### 8.4.2.5 Low Voltage Signaling (LVS)

The TAS2764 monitors the absolute value of the audio stream.

When the input was initially above the programmed threshold set by *LVS\_FTH[4:0]* register bits the Class D was supplied by PVDD rail. If the signal level drops below this threshold for longer than the hysteresis time defined by *LVS\_HYS[3:0]* bits the Class-D supply will switch to VBAT1S.

The *BYP\_EN* pin will be asserted (open drain released). All values of *LVS\_HYS[3:0]* bit settings will ensure the remaining samples will be output before *BYP\_EN* is asserted. When multiple devices have *BYP\_EN* pin connected together, any device requiring a supply voltage higher than the threshold will pull the open drain output low.

When the signal level crosses above the programmed threshold set by *LVS\_FTH[4:0]* bits the Class-D supply will switch to PVDD.

The open-drain *BYP\_EN* pin will be de-asserted (actively pulling the output low) after a delay programmed by the *LVS\_DLY[1:0]* register bits. The Y Bridge will switch from VBAT1S to PVDD after a delay programmed by the *CDS\_DLY[1:0]* register bits.

LVS threshold is set based on the output signal level and is measured in dBFS.

The LVS threshold can alternately be configured to be a value relative to the VBAT1S voltage. To use the alternate configuration set the *LVS\_TMODE* bit to high and use the *LVS\_RTH[3:0]* register bits for setting the threshold.

Below equations show the maximum level of the input signal in order to keep LVS below threshold (Class D switching on VBAT).

For absolute threshold:  $Input\ (dBFS) < LVS\_FTH + (21\ dBV - ChannelGain\ [dBV])$ .

For relative threshold:  $Input\ (dBFS) < 20\log_{10}(VBAT1S * CD\_EFF - LVS\_RTH) + (21\ dBV - ChannelGain\ [dBV]) - 1.5dB$ .

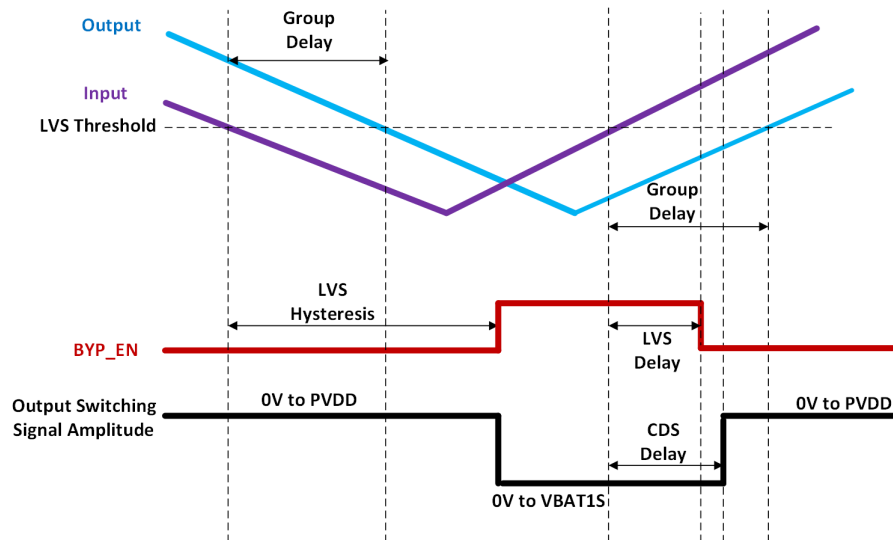
Where:

\* **ChannelGain** = AMP\_LEVEL + DVC\_LVL + SAFE\_MODE (if enabled, it is -18dB).

\* **CD\_EFF** is set by registers 48h-4Bh from page 0x04 and LVH\_RTH is set by bits [3:0] of register 6Ah from page 0x00.

\* **1.5dB** is an inflection factor, already included for absolute threshold.

BOP, Limiter, Thermal Foldback and Thermal Gradient Gain Attenuation should not be taken into account for calculating LV\_EN threshold.



**Figure 8-5. Low Voltage Signaling (Input=0dB, Gain=0dB)**

The group delay numbers are optimized based on whether the Noise Gate feature is enabled or disabled. The delay on CDS\_DLY path and LVS\_DLY path varies depending on sampling rate and whether Noise Gate mode is enabled or not (see [Section 8.9.91](#)).

The LVS fixed thresholds, when *CDS\_MODE[1:0]=11* (*PWR\_MODE2* from [Section 11.1](#)), can be set using register bits *LVS\_FTH\_LOW[1:0]*. When *CDS\_MODE[1:0]=00* (*PWR\_MODE1* and *PWR\_MODE3* from [Section 11.1](#)) the thresholds should be set with register bits *LVS\_FTH[4:0]*.

#### 8.4.2.6 Y-Bridge

The TAS2764 Class-D output uses a Y-Bridge configuration to improve efficiency during playback. The LVS ([Section 8.4.2.5](#)) is internally used to select between the PVDD and VBAT1S supplies. This feature is enabled by setting *CDS\_MODE[1:0]* bits to 2'b00 when both PVDD and VBAT1S are supplied to the device. If not configured to Y-bridge mode the device will use only the selected supply for class-D output even if clipping would otherwise occur. The device can operate using only PVDD to supply class-D output. In this configuration the VBAT1S can be provided from external supply (register bit *VBAT1S=0*) or generated by an internal LDO (register bit *VBAT1S=1*). In this case *CDS\_MODE[1:0]* bits should be set to 2'b10. The TAS2764 Y-Bridge with Low Power

on VBAT1S can be used to switch to the VBAT1S rail only at very low power when close to idle. This will reduce the class-D output swing when near idle and limit the current requirements of the VBAT1S supply. Set the `CDS_MODE[1:0]` register to 2'b11 for this mode.

See [Section 11.1](#) for details on programming the power modes.

The change to the class-D supply determined by the LVS ([Section 8.4.2.5](#)) can have a delay programmed by `CDS_DLY[1:0]` register bits.

When in Y-Bridge mode, if the PVDD falls below (VBAT1S+2.5V) level the Y-bridge will stop switching between supplies and will remain on the PVDD supply.

#### 8.4.2.7 Noise Gate

The TAS2764 has a noise-gate feature that monitors the input signal and powers down the class-D when the signal goes below the threshold set by `NG_LVL[1:0]` bits for longer than the time set by `NG_HYST[1:0]` register bits. When the signal goes above the threshold the class-D will re-power in 7 samples before the samples applied to the audio input interface reach the class-D bridge. This feature is enabled by setting `NG_EN` bit to high. Once enabled it is able to power up and down the channel within the device processing delay requiring no additional external control. Volume ramping can be also used during noise gate operations by setting `NG_DVR_EN` bit to low.

The noise gate can be configured with finer resolution at the expense of additional I<sup>2</sup>C writes. Use `NGFR_EN` bit to enable this mode and register bits `NGFR_LVL[31:0]` to set the fine resolution. The fine resolution hysteresis is set using `NGFR_HYST[18:3]` register bits.

When noise gate is enabled, once the signal is applied, the TAS2764 will be recovering from noise gate. In this case, a shutdown command, if needed, can be programmed in two ways:

- after muting (zero-ing) the incoming data (recommended);
- 100 us after TAS2764 is exiting noise gate (incoming signal is not zero-ed).

#### 8.4.2.8 Supply Tracking Limiter with Brown Out Prevention

The TAS2764 contains a supply tracking limiter to control distortion and brownout prevention to mitigate brownout events. The gain reduction that occurs due to this block can be aligned across multiple devices using the Inter Chip Gain Alignment feature ([Section 8.4.2.9](#)). The maximum device attenuation set by `DEV_MAX_ATTEN[6:0]` register bits can be used to limit the combination of the limiter and brownout attenuation or the Inter Chip Gain Alignment.

The Supply Tracking Limiter ([Section 8.4.2.8.1](#)) and the BOP ([Section 8.4.2.8.2](#)) are configured independently. The Inter Chip Gain Alignment, if enabled, keeps multiple device gains in sync if the Supply Tracking Limiter and BOP need to reduce the gain. However, the BOP will take priority in the device. In order to prevent the Supply Tracking Limiter and BOP from both making simultaneous adjustments to the system, the Supply Tracking Limiter and Inter Chip Gain Alignment will be paused once the BOP engages until it is fully released.

By default, the limiter will attack the audio independent of BOP (bit `LIM_PDB=0`). If it is needed to pause the limiter attenuation when BOP is engaged, the bit `LIM_PDB` should be set to high.

The attenuation applied to the device can be selected to be either the sum of the limiter attenuation (ICLA) and Brownout attenuation (ICBA) or the maximum of the two of them by setting the `ICG_MODE` register bit.

##### 8.4.2.8.1 Supply Tracking Limiter

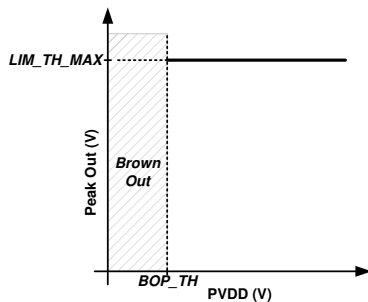
The TAS2764 monitors the PVDD supply voltage and the audio signal to automatically decrease gain when the audio signal peaks exceed a programmable threshold. This helps prevent clipping and extends playback time through end of charge battery conditions. The limiter threshold can be configured to track PVDD below a programmable inflection point with a programmable slope. A minimum threshold sets the limit of threshold reduction from PVDD tracking.

The limiter is enabled by setting the `LIM_EN` bit register to high.

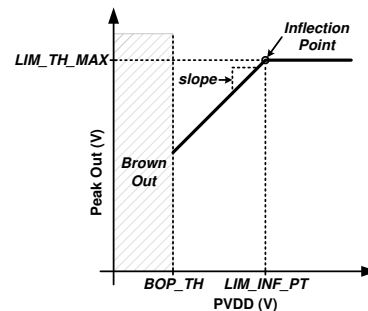
Configurable attack rate, hold time and release rate are provided to shape the dynamic response of the limiter (*LIM\_ATK\_RT[3:0]*, *LIM\_HLD\_TM[2:0]* and *LIM\_RLS\_RT [3:0]* register bits).

A maximum level of attenuation applied by the limiter is configurable via the *LIM\_MAX\_ATTN[3:0]* register bits. If the limiter mode is attacking and if it reaches the maximum attenuation, gain will not be reduced any further.

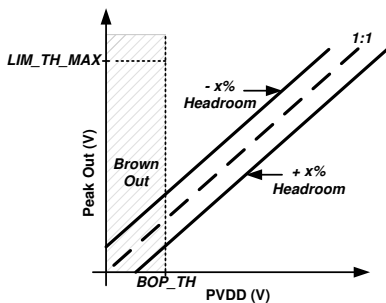
The limiter begins reducing gain when the output signal level is greater than the limiter threshold. The limiter can be configured to track PVDD below a programmable inflection point with a minimum threshold value. [Figure 8-6](#) below shows the limiter configured to limit to a constant level regardless of PVDD level. To achieve this behavior, set the limiter maximum threshold to the desired level via the *LIM\_TH\_MAX[31:0]* register bits. Set the limiter inflection point (register bits *LIM\_INF\_PT[31:0]*) below the minimum allowable PVDD setting. The limiter minimum threshold, set by register bits *LIM\_TH\_MIN[31:0]*, does not impact limiter behavior in this use case.



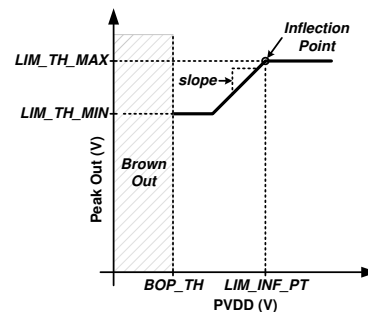
**Figure 8-6. Limiter with Fixed Threshold**



**Figure 8-7. Limiter with Inflection Point**



**Figure 8-8. Limiter with Dynamic Threshold**



**Figure 8-9. Limiter with Inflection Point and Minimum Threshold**

[Figure 8-7](#) shows how to configure the limiter to track PVDD below a threshold without a minimum threshold. Set the *LIM\_TH\_MAX[31:0]* register bits to the desired threshold and *LIM\_INF\_PT[31:0]* register bits to the desired inflection point where the limiter will begin reducing the threshold with PVDD. The *LIM\_SLOPE[31:0]* register bits can be used to change the slope of the limiter tracking with PVDD. The default value of 1 V/V will reduce the threshold 1 V for every 1 V of drop in PVDD. More aggressive tracking slopes can be programmed if desired. Program the *LIM\_TH\_MIN[31:0]* bits below the minimum PVDD to prevent the limiter from having a minimum threshold reduction when tracking PVDD.

The limiter with a supply tracking slope can be configured in an alternate way. By setting *LIM\_HR\_EN* register bit to 1'b1, a headroom can be specified as a percentage of the supply voltage using a 1V/V slope by setting *LIM\_DHR[4:0]* register bits. For example if a headroom of -10% is specified, the peak output voltage will be set to be 10% higher than PVDD. In this use case presented in [Figure 8-8](#) the limiting begins for signals above the supply voltage and will result in a fixed clipping. If a positive headroom of +10% is specified the peak output voltage will be dynamically set 10% below the current PVDD. In this use case the limiting will begin at signal levels lower than the supply voltage and prevent clipping from occurring.

To achieve a limiter that tracks PVDD only up to a minimum threshold, configure the limiter *LIM\_TH\_MAX [31:0]* and *LIM\_SLOPE[31:0]* register bits as in the previous examples. Then additionally set the *LIM\_TH\_MIN[31:0]*



register bits to the desired minimum threshold. Supply voltage below this minimum threshold will not continue to decrease the signal output voltage. This is shown in [Figure 8-9](#).

By setting register bit *LIM\_DHYS\_EN* to low the limiter mechanism depends on settings for maximum/minimum thresholds, inflection point and slope. Once this bit is set high the limiter dynamic headroom is enabled.

When a BOP ([Section 8.4.2.8.2](#)) event occurs the limiter updates can be paused (*LIM\_PDB* register bit set to 1'b1) until the BOP fully releases. This can be used to prevent undesired interactions between both protection systems.

#### 8.4.2.8.2 Brownout Prevention (BOP)

Brownout Prevention (BOP) feature provides a priority input to the limiter to generate a fast response to transient dips in supply voltage at end of charge conditions that can cause system level brownout. When supply voltage dips below the BOP threshold, the limiter begins reducing gain at a configurable attack rate. When supply voltage rises above the BOP threshold, the limiter will begin to release after the programmed hold time. The BOP feature can be enabled by setting the *BOP\_EN* register bit high. The brownout supply source can be set using *BOP\_SRC* register bit to either PVDD (*BOP\_SRC* =1) or VBAT1S (*BOP\_SRC* =0) depending on application need. It should be noted that the BOP feature is independent of the limiter and will function, if enabled, even if the Supply Tracking Limiter is disabled.

The BOP can be configured to attack the gain through four levels as the supply voltage continues to drop. The BOP threshold Level 3 is set using the *BOP\_TH3[7:0]* register bits followed by threshold Level 2 using *BOP\_TH2[7:0]* register bits, Level 1 threshold set by *BOP\_TH1[7:0]* bits and finally crossing Level 0 set by *BOP\_TH0[7:0]* register bits.

The BOP levels that are not used can be disabled individually using register bits *BOP\_DIS0*, *BOP\_DIS1*, *BOP\_DIS2*, *BOP\_DIS\_3* and providing flexibility from one to four levels. Levels should be disabled in the order **3 to 1** for proper operation.

Each level has a separate Attack Rate (register bits *BOP\_ATK\_RT0[2:0]* to *BOP\_ATK\_RT3[2:0]*), Attack Step Size (register bits *BOP\_ATK\_ST0[2:0]* to *BOP\_ATK\_ST3[2:0]*), Release Rate (register bits *BOP\_RLS\_RT0[2:0]* to *BOP\_RLS\_RT3[2:0]*), Release Step Size (register bits *BOP\_RLS\_ST0[3:0]* to *BOP\_RLS\_ST3[3:0]*), Dwell Time (register bits *BOP\_DT0[2:0]* to *BOP\_DT3[2:0]*), Hold Time (register bits *BOP\_HT0[2:0]* to *BOP\_HT3[2:0]*), Maximum Attenuation and Shutdown.

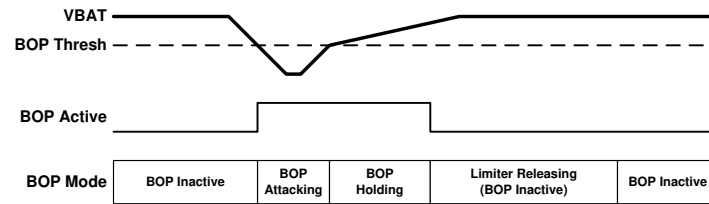
When BOP supply source is set to PVDD input the SAR convertor will not digitize the VBAT1S voltage to reduce latency in the first attack of the BOP engine.

For proper device operation the following conditions must be met:

- ***BOP\_MAX\_ATT0* > *BOP\_MAX\_ATT1* > *BOP\_MAX\_ATT2* > *BOP\_MAX\_ATT3***
- ***BOP\_TH* Level 3 > *BOP\_TH* Level 2 > *BOP\_TH* Level 1 > *BOP\_TH* Level 0.**

Use bits *BOP\_MAX\_ATT0* of registers *BOP\_CFG4*, *BOP\_CFG9*, *BOP\_CFG14*, *BOP\_CFG20* from Register Map to set attenuation levels. Registers *BOP\_CFG5*, *BOP\_CFG10*, *BOP\_CFG15*, *BOP\_CFG21* will be used for setting the BOP threshold levels.

The TAS2764 can also immediately mute and then shutdown the device when a BOP event occurs by reaching Level 0 if the *BOP\_SHDN* register bit is set high. For the device to continue playing audio again it must transition through a SW/HW shutdown state. If the hold time set by *BOP\_HT3[2:0]*, *BOP\_HT2[2:0]*, *BOP\_HT1[2:0]*, *BOP\_HT0[2:0]* register bits is at 7h (**Infinite**) the device needs to transition through a mute or SW/HW shutdown state or the register bit *BOP\_HLD\_CLR* can be set to high (which will cause the device to exit the hold state and begin releasing). This bit is self clearing and will always read-back low.



**Figure 8-10. Brownout Prevention Event**

The TAS2764 BOP engine will keep track of the current level state, the lowest BOP level that has been engaged and the lowest sensed BOP supply voltage. This information is continually updated until requested. When this information is polled the register *BOP\_STAT\_HLD* is set high. This will pause the updates of the current state (*BOP\_STAT\_STATE[3:0]*) and lowest BOP level (*BOP\_STAT\_LLVL[2:0]*) registers bits allowing them to be read back. Once the read is complete the register bit *BOP\_STAT\_HLD* should be set low again clearing the current BOP status registers and re-enabling the updates based on current BOP state.

The lowest PVDD measurement since the last read is also available in register bits *BOP\_STAT\_PVDD[9:0]* if *BOP\_STAT\_HLD* register bit is set high before reading.

BOP Level 0 cannot be disabled and BOP Level 0 thresholds will be fixed by values programmed in registers 0x2E to 0x32 of page 0x00.

#### 8.4.2.9 Inter Chip Gain Alignment

The TAS2764 supports alignment of limiter and brownout prevention dynamics across devices using the dedicated ICC pin ([Section 8.4.2.9.1](#)) or across the TDM output bus. This ensures consistent gain between channels during limiting or brownout events since these dynamics are dependent on audio content, which can vary across channels. Each device can be configured to align to a specified number of other devices, which allows creation of groupings of devices that align only to each other.

Limiter and brownout activity is optionally transmitted by each device on SDOUT or ICC pin in an 24-bit time slot. When both limiter and brownout are enabled the 24-bit slot is comprised of 11-bit limiter and 13-bit brownout data. If only the limiter is enabled the data will be only the 12-bit limiter data. Gain reduction should be transmitted in adjacent time slots for all devices that are to be aligned beginning with the first slot that is specified by the *ICGA\_SLOT[5:0]* register bits. The order of the devices is not important as long as they are adjacent. The time slot for limiter gain reduction is configured by the *GAIN\_SLOT[5:0]* register bits and enabled by the *GAIN\_TX* register bit being set high. The *ICGA\_SEN[7:0]* register bits specify which time slots should be listened to for gain alignment. This allows any number of devices between two and eight to be grouped together. At least two of these devices should be enabled for alignment to take place.

To enable the inter-chip limiter alignment the *ICLA\_EN* register bit should be set to high. To enable the inter chip BOP alignment the *ICBA\_EN* register bit should be set to high. All devices should be configured with identical limiter and brownout prevention settings.

##### 8.4.2.9.1 Inter-Chip Communication (ICC) Pin

The TAS2764 has a dedicated ICC bus pin that can be used for the Inter Chip Gain Alignment ([Section 8.4.2.9](#)). This data pin enables gain alignment without consuming slots on the TDM Port ([Section 8.4.1](#)). The ICC pin is connected to all TAS2764 devices in the system and slots are configured using register bits *GAIN\_SLOT[5:0]*. This bus uses the TDM Port BCLK and FSYNC and requires all devices to be configured using the same sampling clock. The ICC pin supports separate bus keeper configuration from the SDOUT pin on the TDM bus. If the ICC pin is disabled or used for GPIO functionality the gain alignment ([Section 8.4.2.9](#)) will occur on the TDM bus instead of the ICC pin. Register bits *ICC\_MODE[2:0]* are used to set the ICC pin functionality.

#### 8.4.2.10 Class-D Settings

##### 8.4.2.10.1 Synchronization and EMI

The TAS2764 Class-D amplifier supports spread spectrum PWM modulation, which can be enabled by setting the *AMP\_SS* register bit high. This can help reduce EMI in the system.

By default the Class-D amplifier switching frequency is based on the device trimmed internal oscillator. To synchronize switching to the audio sample rate, set the *CLASSD\_SYNC* register bit high. When the Class-D is synchronized to the audio sample rate, the *RAMP\_RATE* register bit must be set depending on the audio sample rate based on either 44.1 kHz or 48 kHz frequency. For 44.1, 88.2 and 176.4 kHz, set *RAMP\_RATE* bit high and for 48, 96 and 192 kHz, set this bit low. This ensures that the internal ramp generator has the appropriate slope.

The TAS2764 supports closed loop edge-rate control on the class-D switching. This feature is enabled by *ERC\_EN* register bit. With a PVDD of less than 8 V the edge rate can slow down up to two times. A slower edge-rate will reduce EMI and degrade efficiency. A faster edge-rate will improve efficiency but result in increased EMI. The edge-rate of the class-D output can be set using *EDGE\_RATE[1:0]* register bits.

### 8.4.3 SAR ADC

An ADC monitors PVDD voltage, VBAT1S voltage and die temperature. The results of these conversions are available via register readback (*PVDD\_CNV*, *VBAT1S\_CNV* and *TMP\_CNV* registers). PVDD and VBAT1S voltage conversions are also used by the limiter and brown out prevention blocks.

When *BOP\_SRC*=1, VBAT1S conversion is not enabled and the ADC monitors only PVDD and temperature.

In order to prevent false triggering of BOP, limiter, thermal foldback, the initial values of SAR at power up are VBAT1S = 6 V, PVDD = 16 V, TEMP = 2.6 °C.

The ADC runs at a rate of 192 kHz with a conversion time of 5.2 μs.

Sampling rate for temperature is 10K samples/sec.

Actual PVDD and VBAT1S voltages are calculated by dividing the *PVDD\_CNV[11:0]* and *VBAT1S\_CNV[11:0]* decimal values of register bits by 128. The die temperature is calculated by subtracting 93 from the decimal value of *TMP\_CNV[7:0]* register bits. The supply voltages PVDD and VBAT1S can be filtered using the proper setting of the *SAR\_FLT[1:0]* register bits but will increase measurement latency. The register bits content should always be read from MSB to LSB.

### 8.4.4 Current and Voltage (IV) Sense

The TAS2764 provides speaker voltage and current sense measurements for real time monitoring of loudspeaker behavior. The *VSNS\_P* and *VSNS\_N* pins should be connected after any ferrite bead filter (or directly to the *OUT\_P* and *OUT\_N* connections if no EMI filter is used). The V-Sense connections eliminate voltage drop error due to packaging, PCB interconnect or ferrite bead filter resistance. The V-sense connections are also used for Post Filter Feed-Back (Section 8.4.5) to correct for any voltage drop induced gain error or non-linearity due to the ferrite bead. It should be noted that any interconnect resistance after the *VSNS* terminals will not be corrected for, so it is advised to connect the sense connections as close to the load as possible.

The voltage and current sense ADCs have a DC blocking filter. This filter can be disabled using the *HPF\_FREQ\_REC[2:0]* register bits.

I-Sense and V-Sense blocks can be powered down by asserting the *ISNS\_PD* and *VSNS\_PD* register bits respectively. When powered down, the device will return null samples for the powered down block.

### 8.4.5 Post Filter Feed-Back (PFFB)

The device support post-filter feedback by closing the amplifier feedback loop after an external filter. The feedback is applied using the *VSNS\_N* and *VSNS\_P* terminals of the device. This feature can be disabled using the *PFFB\_EN* register bit (if an external filter that violates the amplifier loop stability is implemented). When PFFB is disabled, the feedback will be internally routed from the *OUT\_N* and *OUT\_P* pins of the device.

In the PFFB mode of operation the following conditions have to be met:  $f_0 > 10\text{MHz}$  and  $f_0/Q > 2.5\text{MHz}$  ( $f_0$  and  $Q$  are the cutoff frequency and the quality factor of the external filter).

When using PFFB with external LC filtering overshoot might occur at the speaker terminals. It is recommended to connect resistors (see Section 9.2) between speaker terminals and *VSNS* pins to protect internal diodes.

### 8.4.6 Load Diagnostics

The TAS2764 can check the speaker terminal for an open or short. This can be used to verify the continuity of the speaker or the traces to the speaker. The entire operation is performed by the TAS2764 and result is reported using the IRQZ pin or by reading over I<sup>2</sup>C bus on completion. The load diagnostics can be performed using external audio clock (register bit *LDG\_CLK=0*) or the internal oscillator (*LDG\_CLK=1*).

The speaker open (UT) and short (LT) thresholds are configured using the *LDG\_RES\_UT[31:0]* and *LDG\_RES\_LT[31:0]* register bits. The diagnostic is run by selecting one of the load diagnostic modes set by *MODE[2:0]* register bits. The load diagnostic can be run before transitioning to active mode or stand-alone returning to software shutdown when complete. When the load diagnostics is run it will play a 22kHz at -35dBFS for 100ms and measure the resistance of the speaker trace. The result is averaged over the time specified by the *LDG\_AVG[1:0]* register bits. The measured speaker impedance can be read from *LDS\_RES\_VAL[31:0]* register bits.

### 8.4.7 Thermal Foldback

The TAS2764 monitors the die temperature and can automatically limit the audio signal when the die temperature reaches a set threshold. It is recommended to use the thermal fold-back registers to configure this protection mechanism as the internal DSP will perform the necessary calculation for each register.

Thermal fold-back can be disabled using *TFB\_EN* register bit. If the die temperature reaches the value set by *TF\_TEMP\_TH[31:0]* register bits this feature will begin to attenuate the audio signal to prevent the device from shutting down due to over-temperature. It will attenuate the audio signal by a value set in *TF\_LIMS[31:0]* register bits over a range of temperature set by *TF\_TEMP\_TH[31:0]* register bits. The thermal fold-back attack is at a fixed rate of 0.25dB per sample. A maximum attenuation can be specified using register bits *TF\_MAX\_ATTEN[31:0]*. However, if the device continues to heat up, eventually the device over-temperature will be triggered. The attenuation will be held for a number of samples set by register bits *TF\_HOLD\_CNT[31:0]*, before the attenuation will begin releasing.

### 8.4.8 Over Power Protection

The TAS2764 monitors the temperature of the internal power FETs. If the maximum continue power is high and power FETs temperature goes above a threshold, an in-built protection circuit will trigger a thermal foldback and, if temperature still increases, shutdown the device.

The protection mechanism is based on two thresholds TH1 and TH2. The TH1 threshold is set at a temperature 116<sup>0</sup>C higher than the temperature measured by the internal bandgap but not less than 250<sup>0</sup>C. The TH1 threshold triggers a thermal foldback.

The TH2 threshold is 40<sup>0</sup> C above TH1 and triggers thermal shutdown.

The two detection mechanisms can be disabled by setting bits *TH\_DET\_TH2\_EN* and *TH\_DET\_TH1\_EN* of register 0x47, page 0x01 to low.

### 8.4.9 Clocks and PLL

The device clocking is derived from the SBCLK input clock. The tables below show the valid SBCLK clock frequencies for each sample rate and SBCLK to FSYNC ratio (for 44.1 kHz and 48 kHz family frequencies).

If the sample rate is properly configured via the *SAMP\_RATE[2:0]* register bits, no additional configuration is required as long as the SBCLK to FSYNC ratio is valid. The device will detect improper SBCLK frequencies and SBCLK to FSYNC ratios and volume ramp down the playback path to minimize audible artifacts. After the clock error is detected, the device will enter a low power halt mode after a time set by *CLK\_HALT\_TIMER[2:0]* register bits if *CLK\_HALT\_EN* bit is high. Additionally, the device can automatically power up and down on valid clock signals if *CLK\_ERR\_PWR\_EN* register bit is set to high. The device sampling rate should not be changed while this feature is enabled. In this mode the *CLK\_HALT\_EN* bit register should be set high in order for this feature to work properly.

**Table 8-3. Supported SBCLK Frequencies (48 kHz based sample rates)**

Sample Rate (kHz)	SBCLK to FSYNC Ratio						
	16	24	32	48	64	96	125
48 kHz	768 kHz	1.152 MHz	1.536 MHz	2.304 MHz	3.072 MHz	4.608 MHz	6 MHz
96 kHz	1.536 MHz	2.304 MHz	3.072 MHz	4.608 MHz	6.144 MHz	9.216 MHz	12 MHz
Sample Rate (kHz)	SBCLK to FSYNC Ratio						
	128	192	250	256	384	500	512
48 kHz	6.144 MHz	9.216 MHz	12 MHz	12.288 MHz	18.432 MHz	24 MHz	24.576 MHz
96 kHz	12.288 MHz	18.432 MHz	24 MHz	24.576 MHz	-	-	-

**Table 8-4. Supported SBCLK Frequencies (44.1 kHz based sample rates)**

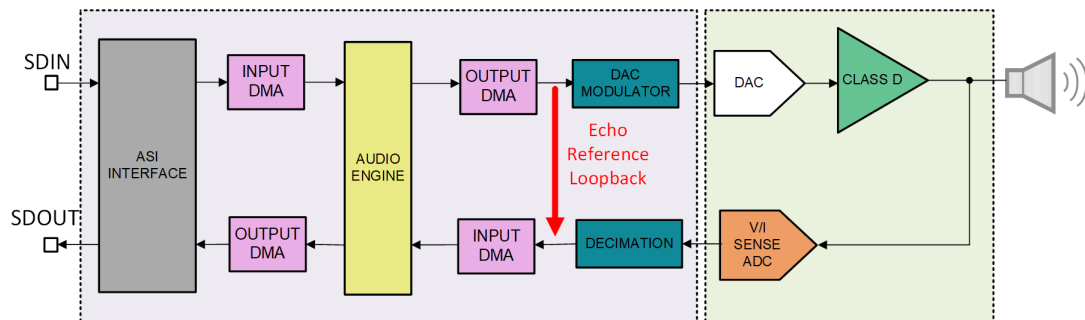
Sample Rate (kHz)	SBCLK to FSYNC Ratio						
	16	24	32	48	64	96	125
44.1 kHz	705.6 kHz	1.0584 MHz	1.4112 MHz	2.1168 MHz	2.8224 MHz	4.2336 MHz	5.5125 MHz
88.2 kHz	1.4112 MHz	2.1168 MHz	2.8224 MHz	4.2336 MHz	5.6448 MHz	8.4672 MHz	11.025 MHz
Sample Rate (kHz)	SBCLK to FSYNC Ratio						
	128	192	250	256	384	500	512
44.1 kHz	5.6448 MHz	8.4672 MHz	11.025 MHz	11.2896 MHz	16.9344 MHz	22.05 MHz	22.5792 MHz
88.2 kHz	11.2896 MHz	16.9344 MHz	22.05 MHz	22.5792 MHz	-	-	-

### 8.4.10 Echo Reference

The TAS2764 has a dedicated mode to loop back the DSP output.

This feature allows user to do noise cancellation or echo correction algorithms.

A block diagram is presented in the figure below.



**Figure 8-11. Echo Reference Loopback**

The echo reference can be enabled by configuring AUDIO\_TX bit in TDM\_CFG12 register. The slot length and the time slot can be selected using AUDIO\_SLEN and AUDIO\_SLOT bits in TDM\_CFG12 register.

## 8.5 Operational Modes

### 8.5.1 Hardware Shutdown

The device enters Hardware Shutdown mode if the SDZ pin is asserted low. In Hardware Shutdown mode, the device consumes the minimum quiescent current from AVDD, VBAT1S and PVDD supplies. All registers loose state in this mode and I<sup>2</sup>C communication is disabled.

In normal shutdown mode if SDZ is asserted low while audio is playing, the device will ramp down volume on the audio, stop the Class-D switching, power down analog and digital blocks and finally put the device into Hardware Shutdown mode. If configured in normal shutdown mode with timeout the device will force a hard shutdown after a timeout set by the configurable shutdown timer (register bits SDZ\_TIMEOUT[1:0]). The device can also be

configured for forced hard shutdown and in this case it will not attempt to gracefully disable the audio channel. The shutdown mode can be controlled using *SDZ\_MODE[1:0]* register bits.

When SDZ is released, the device will sample the ADDR pin and enter the software shutdown mode.

### 8.5.2 Mode Control and Software Reset

The TAS2764 mode can be configured by writing the *MODE[2:0]* register bits.

A software reset can be accomplished by setting high the *SW\_RESET* register bit. This bit is self clearing. Once enabled it will restore all registers to their default values.

### 8.5.3 Software Shutdown

Software Shutdown mode powers down all analog blocks required to playback audio, but does not cause the device to loose register state.

The registers are available through I<sup>2</sup>C interface.

Software Shutdown is enabled by asserting the *MODE[2:0]* register bits to 3'b010. If audio is playing when Software Shutdown is asserted, the Class-D will volume ramp down before shutting down. When de-asserted, the Class-D will begin switching and volume ramp back to the programmed digital volume setting.

### 8.5.4 Mute

The TAS2764 will ramp down volume of the Class-D amplifier to a mute state by setting the *MODE[2:0]* register bits to 3'b001. During mute the Class-D still switches but transmits no audio content. If mute is de-asserted, the device will ramp back the volume to the programmed digital setting.

### 8.5.5 Active

In Active Mode the Class-D switches and plays back audio. Speaker voltage and current sensing are operational if enabled. PDM inputs are also active if enabled. Set the *MODE[2:0]* register bits to 3'b000 to enter active mode.

### 8.5.6 Diagnostic

The TAS2764 has a diagnostic generator that can be used without any clocking applied to the device. If *DG\_CLK* register bit is set low, an internal oscillator is used to generate the test patterns selected by *DG\_SIG[4:0]* register bits. For sine-wave generation the sampling frequency  $f_s$  should be first set using the *SAMP\_RATE[2:0]* register bits.

The programable DC level for diagnostic mode can be set using the *DG\_DC[31:0]* register bits.

*To play a DC diagnostic tone set the bits HPF\_FREQ\_PB[2:0] in register 0x04 to 0h (disabled DC blocker).*

### 8.5.7 Noise Gate

In this mode of operation (see section [Section 8.4.2.7](#) ) the TAS2764 monitors the signal and powers down the class-D when signal goes below a threshold.

## 8.6 Faults and Status

During the power-up sequence, the circuit monitoring the AVDD pin (UVLO) will hold the device in reset (including all configuration registers) until the supply is valid. The device will not exit hardware shutdown until AVDD is valid and the SDZ pin is released. Once SDZ is released, the digital core voltage regulator will power up, enabling detection of the operational mode. If AVDD dips below the UVLO threshold, the device will immediately be forced into a reset state.

The device also monitors the PVDD supply and holds the analog core in power down if the supply is below the UVLO threshold (set by register bits *PVDD\_UVLO\_TH[5:0]*). If the TAS2764 is in active operation and an UVLO fault occurs, the analog blocks will immediately be powered down to protect the device. These faults are latched and require a transition through HW/SW shutdown to clear the fault. The latched registers will report UVLO faults.

The device transitions into software shutdown mode if it detects any faults with the TDM clocks such as:

- Invalid SBCLK to FSYNC ratio
- Invalid FSYNC frequency
- Halting of SBCLK or FSYNC clocks

Upon detection of a TDM clock error, the device transitions into software shutdown mode as quickly as possible to limit the possibility of audio artifacts. Once all TDM clock errors are resolved, the device volume ramps back to its previous playback state. During a TDM clock error, the IRQZ pin will assert low if the clock error interrupt mask register bit *IM\_TDMCE* is set low. The clock fault is also available for read-back in the latched fault status registers (bits *IL\_TDMCE* and *IR\_TDMCE*). Reading the latched fault status register clears the register.

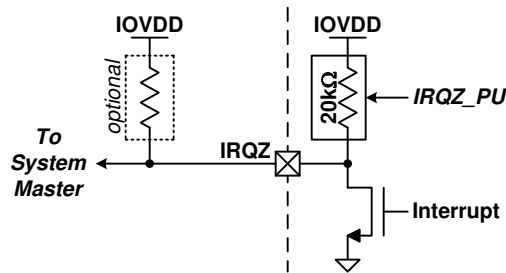
The TAS2764 also monitors die temperature and Class-D load current and will enter software shutdown mode if either of these exceed safe values. As with the TDM clock error, the IRQZ pin will assert low for these faults if the appropriate fault interrupt mask register bit is set low for over temperature and for over current. The fault status can also be monitored in the latched fault registers as with the TDM clock error.

Over temperature warnings and flags are not raised if the device is in Idle or Noise Gate mode.

The status registers (and IRQZ pin if enabled via the status mask register) also indicate limiter behavior including when the limiter is activated, when PVDD is below the inflection point, when maximum attenuation has been applied, when the limiter is in infinite hold and when the limiter has muted the audio.

In the situations when the device operates in PWR\_MODE2 or PWR\_MODE4, the VBAT1S pin is supplied by an internal LDO. Protection circuits monitor this block and generate faults in case of under voltage, over voltage or if the LDO is over loaded. There is no re-try if one of these faults triggers; the device goes into shut down and the IRQZ pin will go low.

The IRQZ pin is an open drain output that asserts low during unmasked fault conditions and therefore must be pulled up with a resistor to IOVDD. An internal pull up resistor is provided in the TAS2764 and can be accessed by setting the *IRQZ\_PU* register bit high. [Figure 8-12](#) below highlights the IRQZ pin circuit.



**Figure 8-12. IRQZ Pin**

The IRQZ interrupt configuration can be set using *IRQZ\_PIN\_CFG[1:0]* register bits. The *IRQZ\_POL* register bit sets the interrupt polarity and *IRQZ\_CLR* register bit allows to clear the interrupt latch register bits.

Live flag registers are active only when the device is in active mode of operation. If the device is put in shutdown by I<sup>2</sup>C command or due to any fault condition described below, the live flags will be reset. Latched flags will not be reset in this condition and available for user to read their status.

**Table 8-5. Fault Interrupt Mask**

Interrupt	Live Register	Latch Register	Mask Register	Default (1 = Mask)
Temp Over 105C	IL_TO105	IR_TO105	IM_TO105	1
Temp Over 115C	IL_TO115	IR_TO115	IM_TO115	1
Temp Over 125C	IL_TO125	IR_TO125	IM_TO125	1
Temp Over 135C	IL_TO135	IR_TO135	IM_TO135	1
Over Temp Error	Device in shutdown	IR_OT	IM_OT	0
Over Current Error	Device in shutdown	IR_OC	IM_OC	0
TDM Clock Error	IL_TDMCE	IR_TDMCE	IM_TDMCE	1

**Table 8-5. Fault Interrupt Mask (continued)**

Interrupt	Live Register	Latch Register	Mask Register	Default (1 = Mask)
TDM Clock Error: Invalid SBCLK ratio or FS rate		IR_TDMCEIR		
TDM Clock Error: FS changed on the fly		IR_TDNCFC		
TDM Clock Error: SBCLK FS ratio changed on the fly		IR_TDMCERC		
BOP Active	IL_BOPA	IR_BOPA	IM_BOPA	0
BOP Level 0 Active	IL_BOPL0A	IR_BOPL0A	IM_BOPL0A	0
BOP Level 1 Active	IL_BOPL1A	IR_BOPL1A	IM_BOPL1A	0
BOP Level 2 Active	IL_BOPL2A	IR_BOPL2A	IM_BOPL2A	0
BOP Level 3 Active	IL_BOPL3A	IR_BOPL3A	IM_BOPL3A	0
BOP Infinite Hold	IL_BOPIH	IR_BOPIH	IM_BOPIH	0
BOP Mute	IL_BOPM	IR_BOPM	IM_BOPM	0
PVDD Below Limiter Inflection	IL_PBIP	IR_PBIP	IM_PBIP	0
Limiter Active	IL_LIMA	IR_LIMA	IM_LIMA	0
Limiter Max Atten	IL_LIMMA	IR_LIMMA	IM_LIMMA	0
PVDD UVLO	Device in shutdown	IR_PUVLO	IM_PUVLO	0
VBAT1S UVLO	Device in shutdown	IR_VBAT1S_UVLO	IM_VBAT1S_UVLO	0
OTP CRC Error	Device in shutdown	IR_OTPCRC		
Load Diagnostic Complete			IM_LDC	1
Load Diagnostic Open/Short Load			IM_SOL[1:0]	[11]
Brownout Device Power Down			IM_BOPD	1
Internal PLL Clock Error	Device in shutdown	IR_PLL_CLK	IM_PLL_CLK	1
Noise Gate Active	IL_NGA			
PVDD-VBAT1S Below Threshold	IL_PVBT	IR_PVBT	IM_PVBT	0
Internal VBAT1S LDO Over Voltage	Device in shutdown	IR_LDO_OV	IM_LDO_OV	1
Internal VBAT1S LDO Under Voltage	Device in shutdown	IR_LDO_UV	IM_LDO_UV	0
Internal VBAT1S LDO Over Load	Device in shutdown	IR_LDO_OL	IM_LDO_OL	1
Thermal Detector Threshold 2	IL_TDTH2	IR_TDTH2	IM_TDTH2	0
Thermal Detector Threshold 1	IL_TDTH1	IR_TDTH1	IM_TDTH1	0

### 8.6.1 Faults and Status over TDM

Faults and device operation information can be sent over the TDM bus when *STATUS\_TX* register bit is set high. The slot position in TDM bus can be configured using *STATUS\_SLOT[5:0]* register bits.

**Table 8-6. TDM Information Bits**

TDM_STATUS[7:0] Bit	Bit Information	0 Value	1 Value
0	Power up state	Powered down <sup>(1)</sup>	Powered up
1	Y-Bridge	PVDD active	VBAT1S active
2	Noise-Gate Status	Normal operation	Noise gate active
3	Limiter Active	No Limiter or ICLA attenuation applied	Limiter or ICLA attenuation applied
4	BOP Active	No BOP attenuation applied	BOP attenuation applied
5	Over Temperature Error	No Over-temperature	Over-temperature detected <sup>(1)</sup>
6	Over Current Error	No Over-current	Over-current detected <sup>(1)</sup>
7	PVDD Status	No PVDD UVLO	PVDD UVLO detected <sup>(1)</sup>

(1) Can be read only during the transient shutdown phase. After shutdown the TDM slots are not available.



## 8.7 Power Sequencing Requirements

There are no power sequencing requirements for order of the supplies other than PVDD and VBAT1S. During power up and power down PVDD voltage must be greater than (VBAT1S-0.7V). See [Section 11](#) for details.

## 8.8 Digital Input Pull Downs

Each digital input and IO has an optional weak pull down to prevent the pin from floating. Register bits *DIN\_PD[4:0]* are used to enable/disable pull downs. The pull downs are not enabled during HW shutdown.

## 8.9 Register Map

### 8.9.1 Register Summary Table Page=0x00

Addr	Register	Description	Section
0x00	PAGE	Device Page	<a href="#">Section 8.9.4</a>
0x01	SW_RESET	Software Reset	<a href="#">Section 8.9.5</a>
0x02	MODE_CTRL	Device operational mode	<a href="#">Section 8.9.6</a>
0x03	CHNL_0	Y Bridge and Channel settings	<a href="#">Section 8.9.7</a>
0x04	DC_BLK0	SAR Filter and DC Path Blocker	<a href="#">Section 8.9.8</a>
0x05	DC_BLK1	ERC and Record DC Blocker	<a href="#">Section 8.9.9</a>
0x06	MISC_CFG1	Misc Configuration 1	<a href="#">Section 8.9.10</a>
0x07	MISC_CFG2	Misc Configuration 2	<a href="#">Section 8.9.11</a>
0x08	TDM_CFG0	TDM Configuration 0	<a href="#">Section 8.9.12</a>
0x09	TDM_CFG1	TDM Configuration 1	<a href="#">Section 8.9.13</a>
0x0A	TDM_CFG2	TDM Configuration 2	<a href="#">Section 8.9.14</a>
0x0B	LIM_MAX_ATTN	Limiter	<a href="#">Section 8.9.15</a>
0x0C	TDM_CFG3	TDM Configuration 3	<a href="#">Section 8.9.16</a>
0x0D	TDM_CFG4	TDM Configuration 4	<a href="#">Section 8.9.17</a>
0x0E	TDM_CFG5	TDM Configuration 5	<a href="#">Section 8.9.18</a>
0x0F	TDM_CFG6	TDM Configuration 6	<a href="#">Section 8.9.19</a>
0x10	TDM_CFG7	TDM Configuration 7	<a href="#">Section 8.9.20</a>
0x11	TDM_CFG8	TDM Configuration 8	<a href="#">Section 8.9.21</a>
0x12	TDM_CFG9	TDM Configuration 9	<a href="#">Section 8.9.22</a>
0x13	TDM_CFG10	TDM Configuration 10	<a href="#">Section 8.9.23</a>
0x14	TDM_CFG11	TDM Configuration 11	<a href="#">Section 8.9.24</a>
0x15	ICC_CNFG2	ICC Mode	<a href="#">Section 8.9.25</a>
0x16	TDM_CFG12	TDM Configuration 12	<a href="#">Section 8.9.26</a>
0x17	ICLA_CFG0	Inter Chip Limiter Alignment 0	<a href="#">Section 8.9.27</a>
0x18	ICLA_CFG1	Inter Chip Gain Alignment 1	<a href="#">Section 8.9.28</a>
0x19	DG_0	Diagnostic Signal	<a href="#">Section 8.9.29</a>
0x1A	DVC	Digital Volume Control	<a href="#">Section 8.9.30</a>
0x1B	LIM_CFG0	Limiter Configuration 0	<a href="#">Section 8.9.31</a>
0x1C	LIM_CFG1	Limiter Configuration 1	<a href="#">Section 8.9.32</a>
0x1D	BOP_CFG0	Brown Out Prevention 0	<a href="#">Section 8.9.33</a>
0x1E	BOP_CFG1	Brown Out Prevention 1	<a href="#">Section 8.9.34</a>
0x1F	BOP_CFG2	Brown Out Prevention 2	<a href="#">Section 8.9.35</a>
0x20	BOP_CFG3	Brown Out Prevention 3	<a href="#">Section 8.9.36</a>
0x21	BOP_CFG4	Brown Out Prevention 4	<a href="#">Section 8.9.37</a>
0x22	BOP_CFG5	BOP Configuration 5	<a href="#">Section 8.9.38</a>
0x23	BOP_CFG6	Brown Out Prevention 6	<a href="#">Section 8.9.39</a>
0x24	BOP_CFG7	Brown Out Prevention 7	<a href="#">Section 8.9.40</a>
0x25	BOP_CFG8	Brown Out Prevention 8	<a href="#">Section 8.9.41</a>
0x26	BOP_CFG9	Brown Out Prevention 9	<a href="#">Section 8.9.42</a>
0x27	BOP_CFG10	BOP Configuration 10	<a href="#">Section 8.9.43</a>

0x28	BOP_CFG11	Brown Out Prevention 11	<a href="#">Section 8.9.44</a>
0x29	BOP_CFG12	Brown Out Prevention 12	<a href="#">Section 8.9.45</a>
0x2A	BOP_CFG13	Brown Out Prevention 13	<a href="#">Section 8.9.46</a>
0x2B	BOP_CFG14	Brown Out Prevention 14	<a href="#">Section 8.9.47</a>
0x2C	BOP_CFG15	BOP Configuration 15	<a href="#">Section 8.9.48</a>
0x2D	BOP_CFG17	Brown Out Prevention 17	<a href="#">Section 8.9.49</a>
0x2E	BOP_CFG18	Brown Out Prevention 18	<a href="#">Section 8.9.50</a>
0x2F	BOP_CFG19	Brown Out Prevention 19	<a href="#">Section 8.9.51</a>
0x30	BOP_CFG20	Brown Out Prevention 20	<a href="#">Section 8.9.52</a>
0x31	BOP_CFG21	BOP Configuration 21	<a href="#">Section 8.9.53</a>
0x32	BOP_CFG22	Brown Out Prevention 22	<a href="#">Section 8.9.54</a>
0x33	BOP_CFG23	Lowest PVDD Measured	<a href="#">Section 8.9.55</a>
0x34	BOP_CFG24	Lowest BOP Attack Rate	<a href="#">Section 8.9.55</a>
0x35	NG_CFG0	Noise Gate 0	<a href="#">Section 8.9.57</a>
0x36	NG_CFG1	Noise Gate 1	<a href="#">Section 8.9.58</a>
0x37	LVS_CFG0	Low Voltage Signaling	<a href="#">Section 8.9.59</a>
0x38	DIN_PD	Digital Input Pin Pull Down	<a href="#">Section 8.9.60</a>
0x39	IO_DRV0	Output Driver Strength	<a href="#">Section 8.9.61</a>
0x3A	IO_DRV1	Output Driver Strength	<a href="#">Section 8.9.62</a>
0x3B	INT_MASK0	Interrupt Mask 0	<a href="#">Section 8.9.63</a>
0x3C	INT_MASK1	Interrupt Mask 1	<a href="#">Section 8.9.64</a>
0x3D	INT_MASK4	Interrupt Mask 4	<a href="#">Section 8.9.65</a>
0x40	INT_MASK2	Interrupt Mask 2	<a href="#">Section 8.9.66</a>
0x41	INT_MASK3	Interrupt Mask 3	<a href="#">Section 8.9.67</a>
0x42	INT_LIVE0	Live Interrupt Read-back 0	<a href="#">Section 8.9.68</a>
0x43	INT_LIVE1	Live Interrupt Read-back 1	<a href="#">Section 8.9.69</a>
0x44	INT_LIVE1_0	Live Interrupt Read-back 1_0	<a href="#">Section 8.9.70</a>
0x47	INT_LIVE2	Live Interrupt Read-back 2	<a href="#">Section 8.9.71</a>
0x48	INT_LIVE3	Live Interrupt Read-back 3	<a href="#">Section 8.9.72</a>
0x49	INT_LTCH0	Latched Interrupt Read-back 0	<a href="#">Section 8.9.73</a>
0x4A	INT_LTCH1	Latched Interrupt Read-back 1	<a href="#">Section 8.9.74</a>
0x4B	INT_LTCH1_0	Latched Interrupt Read-back 1_0	<a href="#">Section 8.9.75</a>
0x4F	INT_LTCH2	Latched Interrupt Read-back 2	<a href="#">Section 8.9.76</a>
0x50	INT_LTCH3	Latched Interrupt Read-back 3	<a href="#">Section 8.9.77</a>
0x51	INT_LTCH4	Latched Interrupt Read-back 4	<a href="#">Section 8.9.78</a>
0x52	VBAT_MSB	SAR VBAT1S 0	<a href="#">Section 8.9.79</a>
0x53	VBAT_LSB	SAR VBAT1S 1	<a href="#">Section 8.9.80</a>
0x54	PVDD_MSB	SAR PVDD 0	<a href="#">Section 8.9.81</a>
0x55	PVDD_LSB	SAR PVDD 1	<a href="#">Section 8.9.82</a>
0x56	TEMP	SAR ADC Conversion 2	<a href="#">Section 8.9.83</a>
0x5C	INT_CLK_CFG	Clock Setting and IRQZ	<a href="#">Section 8.9.84</a>
0x5D	MISC_CFG3	Misc Configuration 3	<a href="#">Section 8.9.85</a>
0x60	CLOCK_CFG	Clock Configuration	<a href="#">Section 8.9.86</a>
0x63	IDLE_IND	Idle channel current optimization	<a href="#">Section 8.9.87</a>
0x65	MISC_CFG4	Misc Configuration 4	<a href="#">Section 8.9.88</a>
0x67	TG_CFG0	Idle Channel Hysterisis	<a href="#">Section 8.9.89</a>
0x68	CLK_CFG	Detect Clock Ration and Sample Rate	<a href="#">Section 8.9.90</a>
0x6A	LV_EN_CFG	Class-D and LVS Delays	<a href="#">Section 8.9.91</a>
0x6B	NG_CFG2	Noise Gate 2	<a href="#">Section 8.9.92</a>
0x6C	NG_CFG3	Noise Gate 3	<a href="#">Section 8.9.93</a>
0x6D	NG_CFG4	Noise Gate 4	<a href="#">Section 8.9.94</a>
0x6E	NG_CFG5	Noise Gate 5	<a href="#">Section 8.9.95</a>

0x6F	NG_CFG6	Noise Gate 6	<a href="#">Section 8.9.96</a>
0x70	NG_CFG7	Noise Gate 7	<a href="#">Section 8.9.97</a>
0x71	PVDD_UVLO	UVLO Threshold	<a href="#">Section 8.9.98</a>
0x76	DAC_MOD_RST	DAC Modulator Reset	<a href="#">Section 8.9.99</a>
0x7D	REV_ID	Revision and PG ID	<a href="#">Section 8.9.100</a>
0x7E	I2C_CKSUM	I2C Checksum	<a href="#">Section 8.9.101</a>
0x7F	BOOK	Device Book	<a href="#">Section 8.9.102</a>

### 8.9.2 Register Summary Table Page=0x01

0x19	LSR	Modulation	<a href="#">Section 8.9.103</a>
0x3D	SDOUT_HIZ_1	Slots Control	<a href="#">Section 8.9.104</a>
0x3E	SDOUT_HIZ_2	Slots Control	<a href="#">Section 8.9.105</a>
0x3F	SDOUT_HIZ_3	Slots Control	<a href="#">Section 8.9.106</a>
0x40	SDOUT_HIZ_4	Slots Control	<a href="#">Section 8.9.107</a>
0x41	SDOUT_HIZ_5	Slots Control	<a href="#">Section 8.9.108</a>
0x42	SDOUT_HIZ_6	Slots Control	<a href="#">Section 8.9.109</a>
0x43	SDOUT_HIZ_7	Slots Control	<a href="#">Section 8.9.110</a>
0x44	SDOUT_HIZ_8	Slots Control	<a href="#">Section 8.9.111</a>
0x45	SDOUT_HIZ_9	Slots Control	<a href="#">Section 8.9.112</a>
0x47	TG_EN	Thermal Detection Enable	<a href="#">Section 8.9.113</a>

### 8.9.3 Register Summary Table Page=0x04

Addr	Register	Description	Section
0x08	DG_DC_VAL1	Diagnostic DC Level	<a href="#">Section 8.9.114</a>
0x09	DG_DC_VAL2	Diagnostic DC Level	<a href="#">Section 8.9.115</a>
0x0A	DG_DC_VAL3	Diagnostic DC Level	<a href="#">Section 8.9.116</a>
0x0B	DG_DC_VAL4	Diagnostic DC Level	<a href="#">Section 8.9.117</a>
0x0C	LIM_TH_MAX1	Limiter Maximum Threshold	<a href="#">Section 8.9.118</a>
0x0D	LIM_TH_MAX2	Limiter Maximum Threshold	<a href="#">Section 8.9.119</a>
0x0E	LIM_TH_MAX3	Limiter Maximum Threshold	<a href="#">Section 8.9.120</a>
0x0F	LIM_TH_MAX4	Limiter Maximum Threshold	<a href="#">Section 8.9.121</a>
0x10	LIM_TH_MIN1	Limiter Minimum Threshold	<a href="#">Section 8.9.122</a>
0x11	LIM_TH_MIN2	Limiter Minimum Threshold	<a href="#">Section 8.9.123</a>
0x12	LIM_TH_MIN3	Limiter Minimum Threshold	<a href="#">Section 8.9.124</a>
0x13	LIM_TH_MIN4	Limiter Minimum Threshold	<a href="#">Section 8.9.125</a>
0x14	LIM_INF_PT1	Limiter Inflection Point	<a href="#">Section 8.9.126</a>
0x15	LIM_INF_PT2	Limiter Inflection Point	<a href="#">Section 8.9.127</a>
0x16	LIM_INF_PT3	Limiter Inflection Point	<a href="#">Section 8.9.128</a>
0x17	LIM_INF_PT4	Limiter Inflection Point	<a href="#">Section 8.9.129</a>
0x18	LIM_SLOPE1	Limiter Slope	<a href="#">Section 8.9.130</a>
0x19	LIM_SLOPE2	Limiter Slope	<a href="#">Section 8.9.131</a>
0x1A	LIM_SLOPE3	Limiter Slope	<a href="#">Section 8.9.132</a>
0x1B	LIM_SLOPE4	Limiter Slope	<a href="#">Section 8.9.133</a>
0x1C	TF_HLD1	TFB Maximum Hold	<a href="#">Section 8.9.134</a>
0x1D	TF_HLD2	TFB Maximum Hold	<a href="#">Section 8.9.135</a>
0x1E	TF_HLD3	TFB Maximum Hold	<a href="#">Section 8.9.136</a>
0x1F	TF_HLD4	TFB Maximum Hold	<a href="#">Section 8.9.137</a>
0x20	TF_RLS1	TFB Release Rate	<a href="#">Section 8.9.138</a>
0x21	TF_RLS2	TFB Release Rate	<a href="#">Section 8.9.139</a>
0x22	TF_RLS3	TFB Release Rate	<a href="#">Section 8.9.140</a>
0x23	TF_RLS4	TFB Release Rate	<a href="#">Section 8.9.141</a>

0x24	TF_SLOPE1	TFB Limiter Slope	<a href="#">Section 8.9.142</a>
0x25	TF_SLOPE2	TFB Limiter Slope	<a href="#">Section 8.9.143</a>
0x26	TF_SLOPE3	TFB Limiter Slope	<a href="#">Section 8.9.144</a>
0x27	TF_SLOPE4	TFB Limiter Slope	<a href="#">Section 8.9.145</a>
0x28	TF_TEMP_TH1	TFB Threshold	<a href="#">Section 8.9.146</a>
0x29	TF_TEMP_TH2	TFB Threshold	<a href="#">Section 8.9.147</a>
0x2A	TF_TEMP_TH3	TFB Threshold	<a href="#">Section 8.9.148</a>
0x2B	TF_TEMP_TH4	TFB Threshold	<a href="#">Section 8.9.149</a>
0x2C	TF_MAX_ATTEN1	TFB Gain Reduction	<a href="#">Section 8.9.150</a>
0x2D	TF_MAX_ATTEN2	TFB Gain Reduction	<a href="#">Section 8.9.151</a>
0x2E	TF_MAX_ATTEN3	TFB Gain Reduction	<a href="#">Section 8.9.152</a>
0x2F	TF_MAX_ATTEN4	TFB Gain Reduction	<a href="#">Section 8.9.153</a>
0x40	LD_CFG0	Load Diagnostics Resistance Upper Threshold	<a href="#">Section 8.9.154</a>
0x41	LD_CFG1	Load Diagnostics Resistance Upper Threshold	<a href="#">Section 8.9.155</a>
0x42	LD_CFG2	Load Diagnostics Resistance Upper Threshold	<a href="#">Section 8.9.156</a>
0x43	LD_CFG3	Load Diagnostics Resistance Upper Threshold	<a href="#">Section 8.9.157</a>
0x44	LD_CFG4	Load Diagnostics Resistance Lower Threshold	<a href="#">Section 8.9.158</a>
0x45	LD_CFG5	Load Diagnostics Resistance Lower Threshold	<a href="#">Section 8.9.159</a>
0x46	LD_CFG6	Load Diagnostics Resistance Lower Threshold	<a href="#">Section 8.9.160</a>
0x47	LD_CFG7	Load Diagnostics Resistance Lower Threshold	<a href="#">Section 8.9.161</a>
0x48	CLD_EFF_1	Class D Efficiency	<a href="#">Section 8.9.162</a>
0x49	CLD_EFF_2	Class D Efficiency	<a href="#">Section 8.9.163</a>
0x4A	CLD_EFF_3	Class D Efficiency	<a href="#">Section 8.9.164</a>
0x4B	CLD_EFF_4	Class D Efficiency	<a href="#">Section 8.9.165</a>
0x4C	LDG_RES1	Load Diagnostics Resistance Value	<a href="#">Section 8.9.166</a>
0x4D	LDG_RES2	Load Diagnostics Resistance Value	<a href="#">Section 8.9.167</a>
0x4E	LDG_RES3	Load Diagnostics Resistance Value	<a href="#">Section 8.9.168</a>
0x4F	LDG_RES4	Load Diagnostics Resistance Value	<a href="#">Section 8.9.169</a>

**NOTE:** all register bits described in italic font can be programmed in Active mode.

**LEGEND:** R/W = Read/Write; R = Read only; -n = value after reset

#### 8.9.4 PAGE (page=0x00 address=0x00) [reset=00h]

Bit	Field	Type	Reset	Description
7-0	PAGE[7:0]	RW	0h	Sets the device page. 00h = Page 0 01h = Page 1 ... FFh = Page 255

#### 8.9.5 SW\_RESET (page=0x00 address=0x01) [reset=00h]

Bit	Field	Type	Reset	Description
7-1	Reserved	R	0h	Reserved
0	SW_RESET	RW	0h	Software reset. Bit is self clearing. 0b = De-asserted 1b = Asserted

### 8.9.6 MODE\_CTRL (page=0x00 address=0x02) [reset=1Ah]

Bit	Field	Type	Reset	Description
7	BOP_SRC	RW	0h	BOP input source and PVDD UVLO 0b = VBAT1S input and PVDD UVLO disabled. * With this bit low at reset all BOP thresholds are by default at 2.75V 1b = PVDD input and PVDD UVLO enabled.
6-5	Reserved	RW	0h	Reserved
4	ISNS_PD	RW	1h	Current sense is 0b = Active 1b = Powered down
3	VSNS_PD	RW	1h	Voltage sense is 0b = Active 1b = Powered down
2-0	MODE[2:0]	RW	2h	Device operational mode. 000b = Active without Mute 001b = Active with Mute 010b = Software Shutdown 011b = Load Diagnostics followed by normal device power up 100b = Standalone Load Diagnostic, after completion these bits are self reset to 010b 101b = Diagnostic Generator Mode 110b-111b = Reserved

### 8.9.7 CHNL\_0 (page=0x00 address=0x03) [reset=28h]

Bit	Field	Type	Reset	Description
7-6	CDS_MODE[1:0]	RW	0h	Class-D switching mode 00b =Y-Bridge, high power on VBAT1S 01b = VBAT1S Only Supply of Class D 10b =PVDD Only Supply of Class D 11b=Y-Bridge, low power on VBAT1S
5-1	AMP_LEVEL[4:0]	RW	14h	Setting 00h 11 dBV 01h 11.5 dBV 02h 12.0 dBV 03h 12.5 dBV ..... 12h 20 dBV 13h 20.5 dBV 14h 21 dBV Others : Reserved
0	Reserved	RW	0h	Reserved

### 8.9.8 DC\_BLK0 (page=0x00 address=0x04) [reset=21h]

Bit	Field	Type	Reset	Description
7	VBAT1S_MODE	RW	0h	VBAT1S supply 0b = Supplied externally 1b = Internal generated from PVDD
6	IRQZ_PU	RW	0h	IRQZ internal pull up enable. 0b = Disabled 1b = Enabled

Bit	Field	Type	Reset	Description
5	AMP_SS <i>*When Spread Spectrum and Sync Mode are both enabled, Sync Mode takes priority</i>	RW	1h	Low EMI spread spectrum is 0b = Disabled 1b = Enabled
4-3	SAR_FLT[1:0]	RW	0h	VBAT1S and PVDD ADC filter frequency 00b = Disabled 01b = 300 KHz 10b = 150 KHz 11b = 50 KHz
2-0	HPF_FREQ_PB[2:0]	RW	1h	Forward Path DC blocker -3dB corner frequency for 48/96 kHz sampling rates 0h = Disabled (filter bypassed) 1h = 2 Hz 2h = 50 Hz 3h = 100 Hz 4h = 200 Hz 5h = 400 Hz 6h = 800 Hz 7h = Reserved * For 44.1/88.2 kHz sampling rates divide the values from above by 1.0884

### 8.9.9 DC\_BLK1 (page=0x00 address=0x05) [reset=41h]

Bit	Field	Type	Reset	Description
7	Reserved	RW	0h	Reserved
6	ERC_EN	RW	1h	Closed-loop edge rate control is 0b = Disabled 1b = Enabled
5-4	EDGE_RATE[1:0]	RW	0h	Class-D ERC control 0h = 1 V/ns 1h = 0.5 V/ns 2h = 0.35 V/ns 3h = 0.25 V/ns
3	TFB_EN	RW	0h	Thermal Foldback is 0b = Disabled 1b = Enabled
2-0	HPF_FREQ_REC[2:0]	RW	1h	Record Path DC blocker -3dB corner frequency for 48/96 kHz sampling rates 0h = Disabled (filter bypassed) 1h = 2 Hz 2h = 50 Hz 3h = 100 Hz 4h = 200 Hz 5h = 400 Hz 6h = 800 Hz 7h = Reserved * For 44.1/88.2 kHz sampling rates divide the values from above by 1.0884

### 8.9.10 MISC\_CFG1 (page=0x00 address=0x06) [reset=00h]

**Table 8-7.**

Bit	Field	Type	Reset	Description
7-6	Reserved	RW	0h	Reserved
5	*OCE_RETRY	RW	0h	Retry after over current event. 0b = Disabled 1b = Enabled, retry after timer.

**Table 8-7. (continued)**

Bit	Field	Type	Reset	Description
4	*OTE_RETRY	RW	0h	Retry after over temperature event. 0b = Disabled 1b = Enabled, retry after timer.
3	PFFB_EN	RW	0h	Post-Filter Feedback is 0b = Disabled (uses OUT) 1b = Enable (uses VSNS)
2	SMODE_EN	RW	0h	When safe mode is enabled adds 18dB attenuation on channel gain. Safe mode is 0b = Disabled 1b = Enabled
1-0	Reserved	R	0h	Reserved

\*Certain limitations applied. Contact TI if need to use this bit.

**8.9.11 MISC\_CFG2 (page=0x00 address=0x07) [reset=20h]**

Bit	Field	Type	Reset	Description
7-6	SDZ_MODE[1:0]	RW	0h	SDZ Mode configuration. 00b = Shutdown after timeout 01b = Immediate forced shutdown 10b = Reserved 11b = Reserved
5-4	SDZ_TIMEOUT[1:0]	RW	2h	SDZ Timeout value 00b = 2 ms 01b = 4 ms 10b = 6 ms 11b = 23.8 ms
3-2	DVC_RAMP_RATE[1:0]	RW	0h	Digital volume control ramp rate for low to high ramp 00b = 0.5 dB per 1 sample 01b = 0.5 dB per 4 samples 10b = 0.5 dB per 8 samples 11b = Volume ramping disabled
1	I2C_GBL_EN	RW	0h	I2c global address is 0b = Disabled 1b = Enabled
0	I2C_AD_DET	RW	0h	Re-detect I2C slave address (self clearing bit). 0b = Normal 1b = Re-detect address

**8.9.12 TDM\_CFG0 (page=0x00 address=0x08) [reset=09h]**

Bit	Field	Type	Reset	Description
7	AMP_INV	RW	0h	Invert audio amplifier output 0b = Normal 1b = Invert
6	CLASSD_SYNC <i>*When Spread Spectrum and Sync Mode are both enabled, Sync Mode takes priority</i>	RW	0h	Class-D synchronization mode. 0b = Not synchronized to audio clocks 1b = Synchronized to audio clocks
5	RAMP_RATE	RW	0h	Sample rate based on 44.1kHz or 48 kHz when CLASSD_SYNC=1. 0b = 48 kHz 1b = 44.1 kHz
4	AUTO_RATE	RW	0h	Auto detection of TDM sample rate. 0b = Enabled 1b = Disabled

Bit	Field	Type	Reset	Description
3-1	SAMP_RATE[2:0]	RW	4h	Sample rate of the TDM bus. 000b-011b = Reserved 100b = 44.1/48 kHz 101b = 88.2/96 kHz 110b-111b = Reserved
0	FRAME_START	RW	1h	TDM frame start polarity. 0b = Low to High on FSYNC 1b = High to Low on FSYNC

**8.9.13 TDM\_CFG1 (page=0x00 address=0x09) [reset=02h]**

Bit	Field	Type	Reset	Description
7	Reserved	R	0h	Reserved
6	RX_JUSTIFY	RW	0h	TDM RX sample justification within the time slot. 0b = Left 1b = Right
5-1	RX_OFFSET[4:0]	RW	1h	TDM RX start of frame to time slot 0 offset (SBCLK cycles).
0	RX_EDGE	RW	0h	TDM RX capture clock polarity. 0b = Rising edge of SBCLK 1b = Falling edge of SBCLK

**8.9.14 TDM\_CFG2 (page=0x00 address=0x0A) [reset=0Ah]**

Bit	Field	Type	Reset	Description
7-6	IVMON_LEN[1:0]	RW	0h	Sets the current and voltage data to length of 00b = 16 bits 01b = 12 bits 10b = 8 bits 11b = Reserved
5-4	RX_SCFG[1:0]	RW	0h	TDM RX time slot select config. 00b = Mono with time slot equal to I2C address offset 01b = Mono left channel 10b = Mono right channel 11b = Stereo downmix (L+R)/2
3-2	RX_WLEN[1:0]	RW	2h	TDM RX word length. 00b = 16-bits 01b = 20-bits 10b = 24-bits 11b = 32-bits
1-0	RX_SLEN[1:0]	RW	2h	TDM RX time slot length. 00b = 16-bits 01b = 24-bits 10b = 32-bits 11b = Reserved

**8.9.15 LIM\_MAX\_ATTEN (page=0x00 address=0x0B) [reset=80h]**

Bit	Field	Type	Reset	Description
7-4	LIM_MAX_ATTEN[3:0]	RW	8h	Limiter Maximum Attenuation 0h = 1 dB 1h = 2 dB 2h = 3 dB ... 0Eh = 15 dB 0Fh = Reserved
3-0	Reserved	R	0h	Reserved



**8.9.16 TDM\_CFG3 (page=0x00 address=0x0C) [reset=10h]**

Bit	Field	Type	Reset	Description
7-4	RX_SLOT_R[3:0]	RW	1h	TDM RX Right Channel Time Slot.
3-0	RX_SLOT_L[3:0]	RW	0h	TDM RX Left Channel Time Slot.

**8.9.17 TDM\_CFG4 (page=0x00 address=0x0D) [reset=13h]**

Bit	Field	Type	Reset	Description
7	TX_KEEPCY	RW	0h	TDM and ICC TX SDOUT LSB data will be driven for full/half cycles when TX_KEEPCY is enabled 0b = Full-cycle 1b = Half-cycle
6	TX_KEEPLN	RW	0h	TDM and ICC TX SDOUT will hold the bus for the following when TX_KEEPCY is enabled 0b = 1 LSB cycle 1b = Always
5	TX_KEEPCEN	RW	0h	TDM and ICC TX SDOUT bus keeper enable. 0b = Disable bus keeper 1b = Enable bus keeper
4	TX_FILL	RW	1h	TDM and ICC TX SDOUT unused bit field fill. 0b = Transmit 0 1b = Transmit Hi-Z
3-1	TX_OFFSET[2:0]	RW	1h	TDM TX start of frame to time slot 0 offset.
0	TX_EDGE	RW	1h	TDM TX launch clock polarity. 0b = Rising edge of SBCLK 1b = Falling edge of SBCLK

**8.9.18 TDM\_CFG5 (page=0x00 address=0x0E) [reset=42h]**

Bit	Field	Type	Reset	Description
7	Reserved	R	0h	Reserved
6	VSNS_TX	RW	1h	TDM TX voltage sense transmit 0b = Disabled 1b = Enabled
5-0	VSNS_SLOT[5:0]	RW	2h	TDM TX voltage sense time slot.

**8.9.19 TDM\_CFG6 (page=0x00 address=0x0F) [reset=40h]**

Bit	Field	Type	Reset	Description
7	Reserved	R	0h	Reserved
6	ISNS_TX	RW	1h	TDM TX current sense transmit 0b = Disabled 1b = Enabled
5-0	ISNS_SLOT[5:0]	RW	0h	TDM TX current sense time slot.

**8.9.20 TDM\_CFG7 (page=0x00 address=0x10) [reset=04h]**

Bit	Field	Type	Reset	Description
7	VBAT1S_SLEN	RW	0h	TDM TX VBAT1S time slot length. 0b = Truncate to 8-bits 1b = Left justify to 16-bits
6	VBAT1S_TX	RW	0h	TDM TX VBAT1S transmit enable. 0b = Disabled 1b = Enabled
5-0	VBAT1S_SLOT[5:0]	RW	4h	TDM TX VBAT1S time slot.

### 8.9.21 TDM\_CFG8 (page=0x00 address=0x11) [reset=05h]

Bit	Field	Type	Reset	Description
7	Reserved	R	0h	Reserved
6	TEMP_TX	RW	0h	TDM TX temp sensor transmit enable. 0b = Disabled 1b = Enabled
5-0	TEMP_SLOT[5:0]	RW	5h	TDM TX temp sensor time slot.

### 8.9.22 TDM\_CFG9 (page=0x00 address=0x12) [reset=06h]

Bit	Field	Type	Reset	Description
7	PVDD_SLEN	RW	0h	TDM TX PVDD time slot length. 0b = Truncate to 8-bits 1b = Left justify to 16-bits
6	PVDD_TX	RW	0h	TDM TX PVDD transmit enable. 0b = Disabled 1b = Enabled
5-0	PVDD_SLOT[5:0]	RW	6h	TDM TX PVDD time slot.

### 8.9.23 TDM\_CFG10 (page=0x00 address=0x13) [reset=08h]

Bit	Field	Type	Reset	Description
7	Reserved	R	0h	Reserved
6	STATUS_TX	RW	0h	TDM TX status transmit enable. 0b = Disabled 1b = Enabled
5-0	STATUS_SLOT[5:0]	RW	8h	TDM TX status time slot.  <b>Bit7-</b> PVDD status(Cannot be read post analog blocks shutdown) 0b = PVDD UVLO not detected 1b = PVDD UVLO detected  <b>Bit6-</b> Over Current status(Cannot be read post analog blocks shutdown) 0b = No OC detected 1b = OC detected  <b>Bit5-</b> Over Temp status(Cannot be read post analog blocks shutdown) 0b = No OT detected 1b = OT detected  <b>Bit4-</b> BOP status 0b = BOP not detected 1b = BOP detected  <b>Bit3-</b> Signal distortion limiter status 0b = No distortion limiter or ICLA gain applied 1b = Gain attenuation done due to distortion limiter/ICLA  <b>Bit2-</b> Noise Gate status 0b = Device in normal mode 1b = Device in Noise Gate mode  <b>Bit1-</b> Class D Power Stage status 0b = Class D Power switch connected to VBAT1S 1b = Class D Power switch connected to PVDD  <b>Bit0-</b> Power Up state (Cannot be read post analog blocks shutdown) 0b = Device is powered down 1b = Device is in active state

### 8.9.24 TDM\_CFG11 (page=0x00 address=0x14) [reset=0Ah]

Bit	Field	Type	Reset	Description
7	Reserved	R	0h	Reserved
6	GAIN_TX	RW	0h	TDM /ICC TX limiter gain reduction transmit enable. 0b = Disabled 1b = Enabled
5-0	GAIN_SLOT[5:0]	RW	Ah	TDM /ICC TX limiter gain reduction time slot. 00h = 0 01h = 1 ..... 3Eh = 62 3Fh = 63

### 8.9.25 ICC\_CNFG2 (page=0x00 address=0x15) [reset=00h]

Bit	Field	Type	Reset	Description
7-5	Reserved	R	0h	Reserved
4-2	ICC_MODE[2:0]	RW	0h	Selects ICC pin function 0h = Gain alignment on ICC pin 1h = Reserved 2h = ICC pin buffers disabled 3h = ICC pin is a general purpose input 4h = ICC pin is a general purpose output 5h-7h = Reserved
1-0	Reserved	R	0h	Reserved

### 8.9.26 TDM\_CFG12 (page=0x00 address=0x16) [reset=12h]

Bit	Field	Type	Reset	Description
7	AUDIO_SLEN	RW	0h	TDM audio slot length 0b = 16-bits 1b = 24-bits
6	AUDIO_TX	RW	0h	TDM audio output transmit is 0b = Disabled 1b = Enabled
5-0	AUDIO_SLOT[5:0]	RW	12h	TDM TX status time slot.

### 8.9.27 ICLA\_CFG0 (page=0x00 address=0x17) [reset=0Ch]

Bit	Field	Type	Reset	Description
7	ICBA_EN	RW	0h	Inter chip brownout gain alignment is 0b = Disabled 1b = Enabled
6-1	ICGA_SLOT[5:0]	RW	6h	Inter chip gain alignment starting time slot.
0	ICLA_EN	RW	0h	Inter chip limiter alignment gain is 0b = Disabled 1b = Enabled

### 8.9.28 ICLA\_CFG1 (page=0x00 address=0x18) [reset=00h]

Bit	Field	Type	Reset	Description
7	ICGA_SEN[7]	RW	0h	Time slot equals ICGA_SLOT[5:0]+7*3. When enabled, the limiter will include this time slot in the alignment group. 0b = Disabled 1b = Enabled

Bit	Field	Type	Reset	Description
6	ICGA_SEN[6]	RW	0h	Time slot equals ICGA_SLOT[5:0]+6*3. When enabled, the limiter will include this time slot in the alignment group. 0b = Disabled 1b = Enabled
5	ICGA_SEN[5]	RW	0h	Time slot equals ICGA_SLOT[5:0]+5*3. When enabled, the limiter will include this time slot in the alignment group. 0b = Disabled 1b = Enabled
4	ICGA_SEN[4]	RW	0h	Time slot equals ICGA_SLOT[5:0]+4*3. When enabled, the limiter will include this time slot in the alignment group. 0b = Disabled 1b = Enabled
3	ICGA_SEN[3]	RW	0h	Time slot equals ICGA_SLOT[5:0]+3*3. When enabled, the limiter will include this time slot in the alignment group. 0b = Disabled 1b = Enabled
2	ICGA_SEN[2]	RW	0h	Time slot equals ICGA_SLOT[5:0]+2*3. When enabled, the limiter will include this time slot in the alignment group. 0b = Disabled 1b = Enabled
1	ICGA_SEN[1]	RW	0h	Time slot equals ICGA_SLOT[5:0]+1*3. When enabled, the limiter will include this time slot in the alignment group. 0b = Disabled 1b = Enabled
0	ICGA_SEN[0]	RW	0h	Time slot equals ICGA_SLOT[5:0]+0. When enabled, the limiter will include this time slot in the alignment group. 0b = Disabled 1b = Enabled

### 8.9.29 DG\_0 (page=0x00 address=0x19) [reset=0Dh]

Bit	Field	Type	Reset	Description
7	ICGA_NG_EN	RW	0h	Better and audio friendly ICGA feature (when Noise gate is enabled) 0b = Feature disabled 1b = Feature enabled
6	DG_CLK	RW	0h	Diagnostic generate clock source is 0b = internal oscillator 1b = external SBCLK and FSYNC
5	ICG_MODE	RW	0h	Device attenuation is 0b = BOP and Limiter attenuation added together 1b = Max attenuation of either BOP or limiter
4-0	DG_SIG[4:0]	RW	Dh	Selects Tone Freq for DG MODE 00h = Zero input (Idle channel) 01h = -6 dBFS positive DC 02h = -6 dBFS negative DC 03h = -12 dBFS positive DC 04h = -12 dBFS negative DC 05h = -18 dBFS positive DC 06h = -18 dBFS negative DC 07h = -24 dBFS positive DC 08h = -24 dBFS negative DC 09h = -30 dBFS positive DC 0Ah = -30 dBFS negative DC 0Bh = -6 dBFS $f_s/4$ 0Ch = -4.8 dBFS $f_s/6$ 0Dh = 0 dBFS 1KHz sine 0Eh = Programmable DC using B0_P4, registers 0x08 to 0x0B 0Fh-1Fh = Reserved

**8.9.30 DVC (page=0x00 address=0x1A) [reset=00h]**

Bit	Field	Type	Reset	Description
7-0	DVC_LVL[7:0]	RW	0h	00h = 0 dB 01h = -0.5 dB 02h = -1 dB ... C8h = -100 dB Others : Mute

**8.9.31 LIM\_CFG0 (page=0x00 address=0x1B) [reset=22h]**

Bit	Field	Type	Reset	Description
7-6	Reserved	R	0h	Reserved
5	LIM_DHYS_EN	RW	1h	Limiter dynamic headroom is 0b = Disabled 1b = Enabled
4-1	LIM_ATK_RT[3:0]	RW	1h	00h = 20 us/dB 01h = 40 us/dB 02h = 80 us/dB 03h = 160 us/dB 04h = 320 us/dB 05h = 640 us/dB 06h = 1280 us/dB 07h = 2560 us/dB 08h = 5120 us/dB 09h = 10240 us/dB Ah = 20480 us/dB Bh = 40960 us/dB Ch = 81920 us/dB Others : Reserved
0	LIM_EN	RW	0h	Limiter is 0b = Disabled 1b = Enabled

**8.9.32 LIM\_CFG1 (page=0x00 address=0x1C) [reset=32h]**

Bit	Field	Type	Reset	Description
7	LIM_PDB	RW	0h	During BOP the limiter will be 0b = Running 1b = Paused
6-3	LIM_RLS_RT[3:0]	RW	6h	00h = Reserved 01h = 4 ms/dB 02h = 8 ms/dB 03h = 16 ms/dB 04h = 32 ms/dB 05h = 64 ms/dB 06h = 128 ms/dB 07h = 256 ms/dB 08h = 512 ms/dB 09h = 1024 ms/dB Ah = 2048 ms/dB Bh = 4096 ms/dB Ch = 8192 ms/dB Others : reserved

Bit	Field	Type	Reset	Description
2-0	LIM_HLD_TM[2:0]	RW	2h	Limiter hold time. 000b = 0 ms 001b = 10 ms 010b = 25 ms 011b = 50 ms 100b = 100 ms 101b = 250 ms 110b = 500 ms 111b = 1000 ms

### 8.9.33 BOP\_CFG0 (page=0x00 address=0x1D) [reset=40h]

Bit	Field	Type	Reset	Description
7-3	LIM_DHR[4:0]	RW	8h	Limiter Maximum Headroom as % of PVDD 00h = -20 % 01h = -17.5 % 02h = -15 % .. 0Fh = 17.5 % 10h = 20 % Others = Reserved
2	Reserved	R	0h	Reserved
1	BOP_SHDN	RW	0h	When BOP level 0 is reached device 0b = Attenuates based on level 0 settings 1b = Mutes followed by device shutdown
0	BOP_EN	RW	0h	Brown out prevention is 0b = Disabled 1b = Enabled

### 8.9.34 BOP\_CFG1 (page=0x00 address=0x1E) [reset=32h]

Bit	Field	Type	Reset	Description
7	BOP_HLD_CLR	RW	0h	BOP infinite hold clear (self clearing). 0b = Don't clear 1b = Clear
6-0	DEV_MAX_ATTEN[6:0]	RW	32h	Device maximum attenuation of limiter and BOP combined. 00h = 0 dB 01h = -1 dB 02h = -2 dB 03h = -3 dB .. 2Eh = -46 dB 2Fh-7Fh = Reserved

### 8.9.35 BOP\_CFG2 (page=0x00 address=0x1F) [reset=02h]

Bit	Field	Type	Reset	Description
7-5	BOP_DT3[2:0]	RW	0h	BOP level 3 dwell time 0h = 0 us 1h = 100 us 2h = 250 us 3h = 500 us 4h = 1000 us 5h = 2000 us 6h = 4000 us 7h = 8000 us

Bit	Field	Type	Reset	Description
4-1	BOP_ATK_ST3[3:0]	RW	1h	BOP level 3 attack step size 0h = -0.0625 dB 1h = -0.5 dB 2h = -0.8958 dB 3h = -1.2916 dB 4h = -1.6874 dB 5h = -2.0832 dB 6h = -2.479 dB 7h = -2.8748 dB 8h = -3.2706 dB 9h = -3.6664 dB Ah = -4.0622 dB Bh = -4.458 dB Ch = -4.8538 dB Dh = -5.2496 dB Eh = -5.6454 dB Fh = -6dB
0	Reserved	R	0h	Reserved

**8.9.36 BOP\_CFG3 (page=0x00 address=0x20) [reset=06h]**

Bit	Field	Type	Reset	Description
7-5	BOP_ATK_RT3[2:0]	RW	0h	BOP level 3 attack rate. 0h = 2.5 us 1h = 5 us 2h = 10 us 3h = 25 us 4h = 50 us 5h = 100 us 6h = 250 us 7h = 500 us
4-1	BOP_RLS_ST3[3:0]	RW	3h	BOP level 3 release step size. 0h = 0.0625 dB 1h = 0.5 dB 2h = 0.8958 dB 3h = 1.2916 dB 4h = 1.6874 dB 5h = 2.0832 dB 6h = 2.479 dB 7h = 2.8748 dB 8h = 3.2706 dB 9h = 3.6664 dB 0Ah = 4.0622 dB 0Bh = 4.458 dB 0Ch = 4.8538 dB 0Dh = 5.2496 dB 0Eh = 5.6454 dB 0Fh = 6 dB
0	Reserved	R	0h	Reserved

**8.9.37 BOP\_CFG4 (page=0x00 address=0x21) [reset=2Ch]**

Bit	Field	Type	Reset	Description
7-5	BOP_RLS_RT3[2:0]	RW	1h	BOP level 3 release rate time. 0h = 5 ms 1h = 10 ms 2h = 25 ms 3h = 50 ms 4h = 100 ms 5h = 250 ms 6h = 500 ms 7h = 1000 ms

Bit	Field	Type	Reset	Description
4-0	BOP_MAX_ATTN3[4:0]	RW	Ch	BOP level 3 maximum attenuation. 00h = 0 dB 01h = -1 dB 02h = -2 dB .. 0Ch = -12 dB .. 1Eh = -30 dB 1Fh = -31 dB

**8.9.38 BOP\_CFG5 (page=0x00 address=0x22) [reset=4Ch]**

Bit	Field	Type	Reset	Description																																							
7-0	BOP_TH3[7:0]	RW	4Ch	BOP level 3 threshold																																							
				<table border="1"> <thead> <tr> <th>Setting</th> <th>BOP Threshold (V) - BOP_SRC=0 (VBAT1S Source)</th> <th>BOP Threshold (V) - BOP_SRC=1 (PVDD Source)</th> </tr> </thead> <tbody> <tr><td>00h</td><td>2.7</td><td>5.5</td></tr> <tr><td>01h</td><td>2.75</td><td>5.55</td></tr> <tr><td>02h</td><td>2.8</td><td>5.6</td></tr> <tr><td>.....</td><td>.....</td><td>.....</td></tr> <tr><td>38h</td><td>5.5</td><td>8.3</td></tr> <tr><td>39h</td><td>0</td><td>8.35</td></tr> <tr><td>.....</td><td>0</td><td>.....</td></tr> <tr><td>5Ah</td><td>0</td><td>10</td></tr> <tr><td>.....</td><td>0</td><td>.....</td></tr> <tr><td>D1h</td><td>0</td><td>15.95</td></tr> <tr><td>D2h</td><td>0</td><td>16</td></tr> <tr><td>D3h-FFh</td><td>0</td><td>0</td></tr> </tbody> </table>	Setting	BOP Threshold (V) - BOP_SRC=0 (VBAT1S Source)	BOP Threshold (V) - BOP_SRC=1 (PVDD Source)	00h	2.7	5.5	01h	2.75	5.55	02h	2.8	5.6	.....	.....	.....	38h	5.5	8.3	39h	0	8.35	.....	0	.....	5Ah	0	10	.....	0	.....	D1h	0	15.95	D2h	0	16	D3h-FFh	0	0
Setting	BOP Threshold (V) - BOP_SRC=0 (VBAT1S Source)	BOP Threshold (V) - BOP_SRC=1 (PVDD Source)																																									
00h	2.7	5.5																																									
01h	2.75	5.55																																									
02h	2.8	5.6																																									
.....	.....	.....																																									
38h	5.5	8.3																																									
39h	0	8.35																																									
.....	0	.....																																									
5Ah	0	10																																									
.....	0	.....																																									
D1h	0	15.95																																									
D2h	0	16																																									
D3h-FFh	0	0																																									

**8.9.39 BOP\_CFG6 (page=0x00 address=0x23) [reset=20h]**

Bit	Field	Type	Reset	Description
7-5	BOP_HT3[2:0]	RW	1h	BOP level 3 hold time. 0h = 0 ms 1h = 10 ms 2h = 100 ms 3h = 250 ms 4h = 500ms 5h = 1000 ms 6h = 2000 ms 7h = Infinite (This can be exited using BOP_HLD_CLR bit)
4	BOP_DIS3	RW	0h	BOP level 3 is 0b = Enabled 1b = Disabled



Bit	Field	Type	Reset	Description
3-0	BOP_STAT_STATE[3:0]	R	0h	BOP current state. Set BOP_STAT_HLD high to hold for readack. 0h = Idle 1h = Attacking Level 3 2h = Attacking Level 2 3h = Attacking Level 1 4h = Attacking Level 0 5h = Holding Level 3 6h = Holding Level 2 7h = Holding Level 1 8h = Holding Level 0 9h = Releasing Level 3 Ah = Releasing Level 2 Bh = Releasing Level 1 Ch = Releasing Level 0 Dh-Fh = Reserved

**8.9.40 BOP\_CFG7 (page=0x00 address=0x24) [reset=02h]**

Bit	Field	Type	Reset	Description
7-5	BOP_DT2[2:0]	RW	0h	BOP level 3 dwell time 0h = 0 us 1h = 100 us 2h = 250 us 3h = 500 us 4h = 1000 us 5h = 2000 us 6h = 4000 us 7h = 8000 us
4-1	BOP_ATK_ST2[3:0]	RW	1h	BOP level 2 attack step size 0h = -0.0625 dB 1h = -0.5 dB 2h = -0.8958 dB 3h = -1.2916 dB 4h = -1.6874 dB 5h = -2.0832 dB 6h = -2.479 dB 7h = -2.8748 dB 8h = -3.2706 dB 9h = -3.6664 dB Ah = -4.0622 dB Bh = -4.458 dB Ch = -4.8538 dB Dh = -5.2496 dB Eh = -5.6454 dB Fh = -6 dB
0	Reserved	R	0h	Reserved

**8.9.41 BOP\_CFG8 (page=0x00 address=0x25) [reset=06h]**

Bit	Field	Type	Reset	Description
7-5	BOP_ATK_RT2[2:0]	RW	0h	BOP level 2 attack rate. 0h = 2.5 us 1h = 5 us 2h = 10 us 3h = 25 us 4h = 50 us 5h = 100 us 6h = 250 us 7h = 500 us

Bit	Field	Type	Reset	Description
4-1	BOP_RLS_ST2[3:0]	RW	3h	BOP level 2 release step size. 0h = 0.0625 dB 1h = 0.5 dB 2h = 0.8958 dB 3h = 1.2916 dB 4h = 1.6874 dB 5h = 2.0832 dB 6h = 2.479 dB 7h = 2.8748 dB 8h = 3.2706 dB 9h = 3.6664 dB Ah = 4.0622 dB Bh = 4.458 dB Ch = 4.8538 dB Dh = 5.2496 dB Eh = 5.6454 dB Fh = 6 dB
0	Reserved	R	0h	Reserved

#### 8.9.42 BOP\_CFG9 (page=0x00 address=0x26) [reset=32h]

Bit	Field	Type	Reset	Description
7-5	BOP_RLS_RT2[2:0]	RW	1h	BOP level 2 release rate time. 0h = 5 ms 1h = 10 ms 2h = 25 ms 3h = 50 ms 4h = 100 ms 5h = 250 ms 6h = 500 ms 7h = 1000 ms
4-0	BOP_MAX_ATTN2[4:0]	RW	12h	BOP level 2 maximum attenuation. 00h = 0 dB 01h = -1 dB 02h = -2 dB .. 0Ch = -12 dB .. 1Eh = -30 dB 1Fh = -31 dB

**8.9.43 BOP\_CFG10 (page=0x00 address=0x27) [reset=46h]**

Bit	Field	Type	Reset	Description		
7-0	BOP_TH2[7:0]	RW	46h	BOP level 2 threshold		
				Setting	BOP Threshold (V) - BOP_SRC=0 (VBAT1S Source)	BOP Threshold (V) - BOP_SRC=1 (PVDD Source)
				00h	2.7	5.5
				01h	2.75	5.55
				02h	2.8	5.6
				.....	.....	.....
				38h	5.5	8.3
				39h	0	8.35
				.....	0	.....
				5Ah	0	10
				.....	0	.....
				D1h	0	15.95
				D2h	0	16
				D3h-FFh	0	0

**8.9.44 BOP\_CFG11 (page=0x00 address=0x28) [reset=20h]**

Bit	Field	Type	Reset	Description
7-5	BOP_HT2[2:0]	RW	1h	BOP level 2 hold time. 0h = 0 ms 1h = 10 ms 2h = 100 ms 3h = 250 ms 4h = 500ms 5h = 1000 ms 6h = 2000 ms 7h = Infinite (This can be exited using BOP_HLD_CLR bit)
4	BOP_DIS2	RW	0h	BOP level 2 is 0b = Enabled 1b = Disabled
3-0	Reserved	R	0h	Reserved

**8.9.45 BOP\_CFG12 (page=0x00 address=0x29) [reset=02h]**

Bit	Field	Type	Reset	Description
7-5	BOP_DT1[2:0]	RW	0h	BOP level 1 dwell time 0h= 0 us 1h = 100 us 2h = 250 us 3h = 500 us 4h = 1000 us 5h = 2000 us 6h = 4000 us 7h = 8000 us

Bit	Field	Type	Reset	Description
4-1	BOP_ATK_ST1[3:0]	RW	1h	BOP level 1 attack step size 0h = -0.0625 dB 1h = -0.5 dB 2h = -0.8958 dB 3h = -1.2916 dB 4h = -1.6874 dB 5h = -2.0832 dB 6h = -2.479 dB 7h = -2.8748 dB 8h = -3.2706 dB 9h = -3.6664 dB Ah = -4.0622 dB Bh = -4.458 dB Ch = -4.8538 dB Dh = -5.2496 dB Eh = -5.6454 dB Fh = -6 dB
0	Reserved	R	0h	Reserved

#### 8.9.46 BOP\_CFG13 (page=0x00 address=0x2A) [reset=06h]

Bit	Field	Type	Reset	Description
7-5	BOP_ATK_RT1[2:0]	RW	0h	BOP level 1 attack rate. 0h = 2.5 us 1h = 5 us 2h = 10 us 3h = 25 us 4h = 50 us 5h = 100 us 6h = 250 us 7h = 500 us
4-1	BOP_RLS_ST1[3:0]	RW	3h	BOP level 1 release step size. 0h = 0.0625 dB 1h = 0.5 dB 2h = 0.8958 dB 3h = 1.2916 dB 4h = 1.6874 dB 5h = 2.0832 dB 6h = 2.479 dB 7h = 2.8748 dB 8h = 3.2706 dB 9h = 3.6664 dB Ah = 4.0622 dB Bh = 4.458 dB Ch = 4.8538 dB Dh = 5.2496 dB Eh = 5.6454 dB Fh = 6 dB
0	Reserved	R	0h	Reserved

#### 8.9.47 BOP\_CFG14 (page=0x00 address=0x2B) [reset=38h]

Bit	Field	Type	Reset	Description
7-5	BOP_RLS_RT1[2:0]	RW	1h	BOP level 1 release rate time. 0h = 5 ms 1h = 10 ms 2h = 25 ms 3h = 50 ms 4h = 100 ms 5h = 250 ms 6h = 500 ms 7h = 1000 ms

Bit	Field	Type	Reset	Description
4-0	BOP_MAX_ATTEN1[4:0]	RW	18h	BOP level 1 maximum attenuation. 0h = 0 dB 1h = -1 dB 2h = -2 dB .. Ch = -12 dB .. 1Eh = -30 dB 1Fh = -31 dB

**8.9.48 BOP\_CFG15 (page=0x00 address=0x2C) [reset=40h]**

Bit	Field	Type	Reset	Description		
7-0	BOP_TH1[7:0]	RW	40h	BOP level 1 threshold		
				Setting	BOP Threshold (V) - BOP_SRC=0 (VBAT1S Source)	BOP Threshold (V) - BOP_SRC=1 (PVDD Source)
				00h	2.7	5.5
				01h	2.75	5.55
				02h	2.8	5.6
				.....	.....	.....
				38h	5.5	8.3
				39h	0	8.35
				.....	0	.....
				5Ah	0	10
				.....	0	.....
				D1h	0	15.95
				D2h	0	16
				D3h-FFh	0	0

**8.9.49 BOP\_CFG17 (page=0x00 address=0x2D) [reset=20h]**

Bit	Field	Type	Reset	Description
7-5	BOP_HT1[2:0]	RW	1h	BOP level 1 hold time. 0h = 0 ms 1h = 10 ms 2h = 100 ms 3h = 250 ms 4h = 500ms 5h = 1000 ms 6h = 2000 ms 7h = Infinite (This can be exited using BOP_HLD_CLR bit)
4	BOP_DIS1	RW	0h	BOP level 1 is 0b = Enabled 1b = Disabled
3-0	Reserved	R	0h	Reserved

**8.9.50 BOP\_CFG18 (page=0x00 address=0x2E) [reset=02h]**

Bit	Field	Type	Reset	Description
7-5	BOP_DT0[2:0]	RW	0h	BOP level 0 dwell time locked 0h= 0 us

Bit	Field	Type	Reset	Description
4-1	BOP_ATK_ST0[3:0]	RW	1h	BOP level 0 attack step size. 3h = -1.2916 dB 4h = -1.6874 dB 5h = -2.0832 dB 6h = -2.479 dB 7h = -2.8748 dB 8h = -3.2706 dB 9h = -3.6664 dB Ah = -4.0622 dB Bh = -4.458 dB Ch = -4.8538 dB Dh = -5.2496 dB Eh = -5.6454 dB Fh = -6 dB
0	Reserved	R	0h	Reserved

### 8.9.51 BOP\_CFG19 (page=0x00 address=0x2F) [reset=06h]

Bit	Field	Type	Reset	Description
7-5	BOP_ATK_RT0[2:0]	RW	0h	BOP level 0 attack rate. 0h = 2.5 us 1h = 5 us 2h = 10 us 3h = 25 us 4h = 50 us 5h = 100 us
4-1	BOP_RLS_ST0[3:0]	RW	3h	BOP level 0 release step size. 0h = 0.0625 dB 1h = 0.5 dB 2h = 0.8958 dB 3h = 1.2916 dB 4h = 1.6874 dB 5h = 2.0832 dB 6h = 2.479 dB 7h = 2.8748 dB 8h = 3.2706 dB 9h = 3.6664 dB Ah = 4.0622 dB Bh = 4.458 dB Ch = 4.8538 dB 0Dh = 5.2496 dB Eh = 5.6454 dB Fh = 6 dB
0	Reserved	R	0h	Reserved

### 8.9.52 BOP\_CFG20 (page=0x00 address=0x30) [reset=3Eh]

Bit	Field	Type	Reset	Description
7-5	BOP_RLS_RT0[2:0]	RW	1h	BOP level 0 release rate time. 0h = 5 ms 1h = 10 ms 2h = 25 ms 3h = 50 ms 4h = 100 ms 5h = 250 ms 6h = 500 ms 7h = 1000 ms

Bit	Field	Type	Reset	Description
4-0	BOP_MAX_ATTNO[4:0]	RW	1Eh	BOP level 0 maximum attenuation. 0h - Bh= Reserved Ch = -12 dB .. 1Eh = -30 dB 1Fh = -31 dB

**8.9.53 BOP\_CFG21 (page=0x00 address=0x31) [reset=37h]**

Bit	Field	Type	Reset	Description																																				
7-0	BOP_TH0[7:0]	RW	37h	BOP level 0 threshold																																				
				<table border="1"> <thead> <tr> <th>Setting</th> <th>BOP Threshold (V) - BOP_SRC=0 (VBAT1S Source)</th> <th>BOP Threshold (V) - BOP_SRC=1 (PVDD Source)</th> </tr> </thead> <tbody> <tr> <td>00h</td> <td>2.7</td> <td>5.5</td> </tr> <tr> <td>01h</td> <td>2.75</td> <td>5.55</td> </tr> <tr> <td>02h</td> <td>2.8</td> <td>5.6</td> </tr> <tr> <td>.....</td> <td>.....</td> <td>.....</td> </tr> <tr> <td>37h</td> <td>5.45</td> <td>8.3</td> </tr> <tr> <td>38h</td> <td>5.5</td> <td>8.35</td> </tr> <tr> <td>39h</td> <td>0</td> <td>8.4</td> </tr> <tr> <td>.....</td> <td>0</td> <td>.....</td> </tr> <tr> <td>D1h</td> <td>0</td> <td>15.95</td> </tr> <tr> <td>D2h</td> <td>0</td> <td>16</td> </tr> <tr> <td>D3h-FFh</td> <td>0</td> <td>0</td> </tr> </tbody> </table>	Setting	BOP Threshold (V) - BOP_SRC=0 (VBAT1S Source)	BOP Threshold (V) - BOP_SRC=1 (PVDD Source)	00h	2.7	5.5	01h	2.75	5.55	02h	2.8	5.6	.....	.....	.....	37h	5.45	8.3	38h	5.5	8.35	39h	0	8.4	.....	0	.....	D1h	0	15.95	D2h	0	16	D3h-FFh	0	0
Setting	BOP Threshold (V) - BOP_SRC=0 (VBAT1S Source)	BOP Threshold (V) - BOP_SRC=1 (PVDD Source)																																						
00h	2.7	5.5																																						
01h	2.75	5.55																																						
02h	2.8	5.6																																						
.....	.....	.....																																						
37h	5.45	8.3																																						
38h	5.5	8.35																																						
39h	0	8.4																																						
.....	0	.....																																						
D1h	0	15.95																																						
D2h	0	16																																						
D3h-FFh	0	0																																						

**8.9.54 BOP\_CFG22 (page=0x00 address=0x32) [reset=20h]**

Bit	Field	Type	Reset	Description
7-5	BOP_HT0[2:0]	RW	1h	BOP level 0 hold time. 0h - 1h = Reserved 2h = 100 ms 3h = 250 ms 4h = 500ms 5h = 1000 ms 6h = 2000 ms 7h = Infinite (This can be exited using BOP_HLD_CLR bit)
4	BOP_DIS0	RW	0h	BOP level 0 is 0b = Enabled 1b = Disabled
3-1	Reserved	RW	0h	Reserved
0	BOP_STAT_HLD	RW	0h	Hold BOP status for BOP_STAT_STATE, BOP_STAT_LLVL, and BOP_STAT_PVDD. When register is set back to low the status registers will be reset and updating will resume. 0b= hold update disabled, status register readback invalid 1b= hold update enabled, status register readback valid

**8.9.55 BOP\_CFG23 (page=0x00 address=0x33) [reset=FFh]**

Bit	Field	Type	Reset	Description
7-0	BOP_STAT_PVDD[9:2]	R	FFh	Lowest PVDD measured since last read. Set BOP_STAT_HLD high before reading. Till the time SAR does not get enabled in device, this register will readback default value on PVDD (0xff) if device is in PWR_MODE2, else it will readback default value on VBAT (0xff) when device is in PWR_MODE1. Note: default of PVDD is 16V and of VBAT is 6V.

**8.9.56 BOP\_CFG24 (page=0x00 address=0x34) [reset=E6h]**

Bit	Field	Type	Reset	Description
7-6	BOP_STAT_PVDD[1:0]	R	3h	Lowest PVDD measured since last read. Set BOP_STAT_HLD high before reading. Till the time SAR does not get enabled in device, this register will readback default value on PVDD (2'b11) if device is in PWR_MODE2, else it will readback default value on VBAT (2'b11) when device is in PWR_MODE1. Note: default of PVDD is 16V and of VBAT is 6V.
5-3	BOP_STAT_LLVL[2:0]	R	4h	Lowest BOP level attacked since last read. Set BOP_STAT_HLD high before reading. 0h = Attack level 0 was lowest attack level 1h = Attack level 1 was lowest attack level 2h = Attack level 2 was lowest attack level 3h = Attack level 3 was lowest attack level 4h = No BOP attacked since last read
2-1	LVS_FTH_LOW[1:0]	RW	3h	Threshold for LVS when CDS_MODE=2'b11 0h = -121.5 dBFS 1h = -101.5 dBFS (default) 2h = -81.5 dBFS 3h = -71.5 dBFS
0	Reserved	R	0h	Reserved

**8.9.57 NG\_CFG0 (page=0x00 address=0x35) [reset=BDh]**

Bit	Field	Type	Reset	Description
7-5	NG_HSYT[2:0]	RW	5h	Noise Gate Entry hysteresis timer 0h = 260us 1h = 500us 2h = 800us 3h = 2 ms 4h = 10 ms 5h = 50 ms 6h = 100 ms 7h = 1000 ms
4-3	NG_LVL[1:0]	RW	3h	Noise-gate audio threshold level 0h = -90 dBFS 1h = -100 dBFS 2h = -110 dBFS 3h = -120 dBFS
2	NG_EN	RW	1h	Noise gate 0b = Disabled 1b = Enabled
1-0	Reserved	RW	1h	Reserved

**8.9.58 NG\_CFG1 (page=0x00 address=0x36) [reset=ADh]**

Bit	Field	Type	Reset	Description
7-6	Reserved	RW	2h	Reserved
5	NG_DVR_EN	RW	1h	Volume ramping on noise-gate control is 0b = Enabled 1b = Disabled
4	Reserved	R	0h	Reserved
3-0	LVS_HYS[3:0]	RW	Dh	PVDD to VBAT1S hysteresis time 0h - 9h = Reserved Ah = 1 ms Bh = 10 ms Ch = 20 ms Dh = 50 ms Eh = 75 ms Fh = 100 ms



### 8.9.59 LVS\_CFG0 (page=0x00 address=0x37) [reset=A8h]

Bit	Field	Type	Reset	Description
7	LVS_TMODE	RW	1h	Low-Voltage signaling detection threshold is 0b = Fixed 1b = Relative to VBAT1S voltage
6	Reserved	RW	0h	Reserved
5	Reserved	RW	1h	Reserved
4-0	LVS_FTH[4:0]	RW	8h	Threshold for LVS when CDS_MODE=2'b00 0h = -18.5 dBFS 1h=-18.25 dBFS (default) 2h=-18 dBFS 3h = -17.75 dBFS 4h=-17.5 dBFS .. 8h=-16.5 dBFS .. 1Eh=-11 dBFS 1Fh=-10.75 dBFS

### 8.9.60 DIN\_PD (page=0x00 address=0x38) [reset=03h]

Bit	Field	Type	Reset	Description
7	Reserved	RW	0h	Reserved
6	DIN_PD[4]	RW	0h	Weak pull down for ICC 0b = Disabled 1b = Enabled
5	DIN_PD[3]	RW	0h	Weak pull down for SDOUT. 0b = Disabled 1b = Enabled
4	DIN_PD[2]	RW	0h	Weak pull down for SDIN. 0b = Disabled 1b = Enabled
3	DIN_PD[1]	RW	0h	Weak pull down for FSYNC. 0b = Disabled 1b = Enabled
2	DIN_PD[0]	RW	0h	Weak pull down for SBCLK. 0b = Disabled 1b = Enabled
1-0	Reserved	RW	3h	Reserved

### 8.9.61 IO\_DRV0 (page=0x00 address=0x39) [reset=FFh]

Bit	Field	Type	Reset	Description
7-6	SDA_IO_DS[1:0]	RW	3h	SDA Drive Strength 00b = 2 mA 01b = 4 mA 10b = 6 mA 11b = 8 mA
5-4	Reserved	RW	3h	Reserved
3-2	SDOUT_IO_DS[1:0]	RW	3h	SDOUT Drive Strength 00b = 2 mA 01b = 4 mA 10b = 6 mA 11b = 8 mA

Bit	Field	Type	Reset	Description
1-0	ICC_IO_DS[1:0]	RW	3h	ICC Drive Strength 00b = 2 mA 01b = 4 mA 10b = 6 mA 11b = 8 mA

**8.9.62 IO\_DRV1 (page=0x00 address=0x3A) [reset=FFh]**

Bit	Field	Type	Reset	Description
7-6	SBCLK_IO_DS[1:0]	RW	3h	SBCLK Drive Strength 00b = 2 mA 01b = 4 mA 10b = 6 mA 11b = 8 mA
5-4	Reserved	RW	3h	Reserved
3-2	IRQZ_IO_DS[1:0]	RW	3h	IRQZ Drive Strength 00b = 2 mA 01b = 4 mA 10b = 6 mA 11b = 8 mA
1-0	BYP_EN_IO_DS[1:0]	RW	3h	Bypass Enable Drive Strength 00b = 2 mA 01b = 4 mA 10b = 6 mA 11b = 8 mA

**8.9.63 INT\_MASK0 (page=0x00 address=0x3B) [reset=FCh]**

Bit	Field	Type	Reset	Description
7	<i>IM_BOPM</i>	RW	1h	BOP mute interrupt. 0b = Don't Mask 1b = Mask
6	<i>IM_BOPIH</i>	RW	1h	Bop infinite hold interrupt. 0b = Don't Mask 1b = Mask
5	<i>IM_LIMMA</i>	RW	1h	Limiter max attenuation interrupt. 0b = Don't Mask 1b = Mask
4	<i>IM_PBIP</i>	RW	1h	PVDD below limiter inflection point interrupt. 0b = Don't Mask 1b = Mask
3	<i>IM_LIMA</i>	RW	1h	Limiter active interrupt. 0b = Don't Mask 1b = Mask
2	<i>IM_TDMCE</i>	RW	1h	TDM clock error interrupt. 0b = Don't Mask 1b = Mask
1	<i>IM_OC</i>	RW	0h	Over current error interrupt. 0b = Don't Mask 1b = Mask
0	<i>IM_OT</i>	RW	0h	Over temp error interrupt. 0b = Don't Mask 1b = Mask

**8.9.64 INT\_MASK1 (page=0x00 address=0x3C) [reset=BEh]**

Bit	Field	Type	Reset	Description
7-6	Reserved	RW	2h	Reserved

Bit	Field	Type	Reset	Description
5	IM_LDC	RW	1h	Load Diagnostic Completion Mask 0b = Don't Mask 1b = Masked
4	IM_SOL[1:0]	RW	3h	Load Mask 00b = Don't Mask 01b = Mask Open Load Detection 10b = Mask Short Load Detection 01b = Mask Open/Short Load Detection
2	IM_BOPSD *If BOP_SHDN=1 and brownout is detected DSP shuts down if not masked	RW	1h	BOP Started Mask 0b = Don't Mask 1b = Mask
1-0	Reserved	RW	2h	Reserved

**8.9.65 INT\_MASK4 (page=0x00 address=0x3D) [reset=DFh]**

Bit	Field	Type	Reset	Description
7	IM_PLL_CLK	RW	1h	Internal PLL Derived Clock Error Mask 0b = Don't Mask 1b = Mask
6	Reserved	RW	1h	Reserved
5	IM_VBAT1S_UVLO	RW	0h	VBAT1S Under Voltage 0b = Don't Mask 1b = Mask
4-0	Reserved	RW	1Fh	Reserved

**8.9.66 INT\_MASK2 (page=0x00 address=0x40) [reset=F6h]**

Bit	Field	Type	Reset	Description
7	IM_TO105	RW	1h	Temperature over 105C interrupt. 0b = Don't Mask 1b = Mask
6	IM_TO115	RW	1h	Temperature over 115C interrupt. 0b = Don't Mask 1b = Mask
5	IM_TO125	RW	1h	Temperature over 125C interrupt. 0b = Don't Mask 1b = Mask
4	IM_TO135	RW	1h	Temperature over 135C interrupt. 0b = Don't Mask 1b = Mask
3	IM_LDO_UV	RW	0h	Internal VBAT1S LDO Under Voltage 0b = Don't Mask 1b = Mask
2	IM_LDO_OV	RW	1h	Internal VBAT1S LDO Over Voltage 0b = Don't Mask 1b = Mask
1	IM_LDO_OL	RW	1h	Internal VBAT1S LDO Over Load 0b = Don't Mask 1b = Mask
0	IM_PUVLO	RW	0h	PVDD UVLO interrupt. 0b = Don't Mask 1b = Mask

**8.9.67 INT\_MASK3 (page=0x00 address=0x41) [reset=00h]**

Bit	Field	Type	Reset	Description
7	IM_TDTH2	RW	0h	Thermal Detection Threshold 2 mask 0b = Don't Mask 1b = Mask
6	IM_TDTH1	RW	0h	Thermal Detection Threshold 1 mask 0b = Don't Mask 1b = Mask
5	IM_PVBT	RW	0h	PVDD - VBAT1S below threshold mask 0b = Don't Mask 1b = Mask
4	IM_BOPA	RW	0h	BOP active interrupt. Mask 0b = Don't mask 1b = Mask
3	IM_BOPL3A	RW	0h	BOP level 3 detected interrupt mask 0b = Don't mask 1b = Mask
2	IM_BOPL2A	RW	0h	BOP level 2 detected interrupt mask 0b = Don't mask 1b = Mask
1	IM_BOPL1A	RW	0h	BOP level 1 detected interrupt mask 0b = Don't mask 1b = Mask
0	IM_BOPL0A	RW	0h	BOP level 0 detected interrupt mask 0b = Don't mask 1b = Mask

**8.9.68 INT\_LIVE0 (page=0x00 address=0x42) [reset=00h]**

Bit	Field	Type	Reset	Description
7	IL_BOPM	R	0h	Interrupt due to bop mute. 0b = No interrupt 1b = Interrupt
6	IL_BOPIH	R	0h	Interrupt due to bop infinite hold. 0b = No interrupt 1b = Interrupt
5	IL_LIMMA	R	0h	Interrupt due to limiter max attenuation. 0b = No interrupt 1b = Interrupt
4	IL_PBIP	R	0h	Interrupt due to PVDD below limiter inflection point. 0b = No interrupt 1b = Interrupt
3	IL_LIMA	R	0h	Interrupt due to limiter active. 0b = No interrupt 1b = Interrupt
2	IL_TDMCE	R	0h	Interrupt due to TDM clock error. 0b = No interrupt 1b = Interrupt - <b>Device in shutdown</b>
1	IL_OC	R	0h	Interrupt due to over current error. 0b = No interrupt 1b = Interrupt - <b>Device in shutdown</b>
0	IL_OT	R	0h	Interrupt due to over temp error. 0b = No interrupt 1b = Interrupt - <b>Device in shutdown</b>

**8.9.69 INT\_LIVE1 (page=0x00 address=0x43) [reset=00h]**

Bit	Field	Type	Reset	Description
7	Reserved	R	0h	Reserved
6	IL_OTPCRC	R	0h	Interrupt due to OTP CRC Error Flag 0b = No interrupt 1b = Interrupt - <b>Device in shutdown</b>
5-3	Reserved	R	0h	Reserved
2	IL_NGA	R	0h	Noise Gate Active flag 0b = Noise gate not detected 1b = Noise gate detected
1-0	Reserved	R	0h	Reserved

**8.9.70 INT\_LIVE1\_0 (page=0x00 address=0x44) [reset=00h]**

Bit	Field	Type	Reset	Description
7	IL_PLL_CLK	R	0h	Internal PLL Clock Error 0b = No interrupt 1b = Interrupt - <b>Device in shutdown</b>
6	Reserved	R	0h	Reserved
5	IL_VBAT1S_UVLO	R	0h	VBAT1S Under Voltage 0b = No interrupt 1b = Interrupt - <b>Device in shutdown</b>
4-0	Reserved	R	0h	Reserved

**8.9.71 INT\_LIVE2 (page=0x00 address=0x47) [reset=00h]**

Bit	Field	Type	Reset	Description
7	IL_TO105	R	0h	Temperature over 105C 0b = No Interrupt 1b = Interrupt
6	IL_TO115	R	0h	Temperature over 115C 0b = No Interrupt 1b = Interrupt
5	IL_TO125	R	0h	Temperature over 125C 0b = No Interrupt 1b = Interrupt
4	IL_TO135	R	0h	Temperature over 135C 0b = No Interrupt 1b = Interrupt
3	IL_LDO_UV	R	0h	VBAT1S Internal LDO Under Voltage 0b = No Interrupt 1b = Interrupt - <b>Device in shutdown</b>
2	IL_LDO_OV	R	0h	VBAT1S Internal LDO Over Voltage 0b = No Interrupt 1b = Interrupt - <b>Device in shutdown</b>
1	IL_LDO_OL	R	0h	VBAT1S Internal LDO Over Load 0b = No Interrupt 1b = Interrupt - <b>Device in shutdown</b>
0	IL_PUVLO	R	0h	PVDD UVLO 0b = No Interrupt 1b = Interrupt - <b>Device in shutdown</b>

### 8.9.72 INT\_LIVE3 (page=0x00 address=0x48) [reset=00h]

Bit	Field	Type	Reset	Description
7	IL_TDTH2	R	0h	Thermal Detection Threshold 2 active flag 0b = No interrupt 1b = Interrupt
6	IL_TDTH1	R	0h	Thermal Detection Threshold 1 active flag 0b = No interrupt 1b = Interrupt
5	IL_PVBT	R	0h	PVDD -VBAT1S going below the threshold flag 0b = No interrupt 1b = Interrupt
4	IL_BOPA	R	0h	BOP active flag 0b = No interrupt 1b = Interrupt
3	IL_BOPL3A	R	0h	BOP level 3 detected flag 0b = No interrupt 1b = Interrupt
2	IL_BOPL2A	R	0h	BOP level 2 detected flag 0b = No interrupt 1b = Interrupt
1	IL_BOPL1A	R	0h	BOP level 1 detected flag 0b = No interrupt 1b = Interrupt
0	IL_BOPL0A	R	0h	BOP level 0 detected flag 0b = No interrupt 1b = Interrupt

### 8.9.73 INT\_LTCH0 (page=0x00 address=0x49) [reset=00h]

Bit	Field	Type	Reset	Description
7	IR_BOPM	R	0h	Interrupt due to bop mute. 0b = No interrupt 1b = Interrupt
6	IR_BOPIH	R	0h	Interrupt due to BOP infinite hold. 0b = No interrupt 1b = Interrupt
5	IR_LIMMA	R	0h	Interrupt due to limiter max attenuation. 0b = No interrupt 1b = Interrupt
4	IR_PBIP	R	0h	Interrupt due to PVDD below limiter inflection point. 0b = No interrupt 1b = Interrupt
3	IR_LIMA	R	0h	Interrupt due to limiter active 0b = No interrupt 1b = Interrupt
2	IR_TDMCE	R	0h	Interrupt due to TDM clock error. Type of clock error can be seen from INT_LTCH8 0b = No interrupt 1b = Interrupt
1	IR_OC	R	0h	Interrupt due to over current error 0b = No interrupt 1b = Interrupt
0	IR_OT	R	0h	Interrupt due to over temp error 0b = No interrupt 1b = Interrupt

**8.9.74 INT\_LTCH1 (page=0x00 address=0x4A) [reset=00h]**

Bit	Field	Type	Reset	Description
7	Reserved	R	0h	Reserved
6	IR_OTPCRC	R	0h	Interrupt due to OTP CRC Error Flag. 0b = No interrupt 1b = Interrupt
5	IR_LDC	R	0h	Interrupt due to load diagnostic completion. 0b = Not completed 1b = Completed
4-3	IR_LDSDL IR_LDO	R	0h	Interrupt due to Load Diagnostic Mode Fault Status 00b = Normal Load 01b = Open Load Detected 10b = Short Load Detected 11b = Reserved
2-0	Reserved	R	0h	Reserved

**8.9.75 INT\_LTCH1\_0 (page=0x00 address=0x4B) [reset=00h]**

Bit	Field	Type	Reset	Description
7	IR_PLL_CLK	R	0h	Internal PLL Clock Error
6	Reserved	R	0h	Reserved
5	IR_VBAT1S_UVLO	R	0h	VBAT1S Under Voltage
4-0	Reserved	R	0h	Reserved

**8.9.76 INT\_LTCH2 (page=0x00 address=0x4F) [reset=00h]**

Bit	Field	Type	Reset	Description
7	IR_TO105	R	0h	Temperature over 105C 0b = No Interrupt 1b = Interrupt
6	IR_TO115	R	0h	Temperature over 115C 0b = No Interrupt 1b = Interrupt
5	IR_TO125	R	0h	Temperature over 125C 0b = No Interrupt 1b = Interrupt
4	IR_TO135	R	0h	Temperature over 135C 0b = No Interrupt 1b = Interrupt
3	IR_LDO_UV	R	0h	Internal VBAT1S LDO Under Voltage 0b = No Interrupt 1b = Interrupt
2	IR_LDO_OV	R	0h	Internal VBAT1S LDO Over Voltage 0b = No Interrupt 1b = Interrupt
1	IR_LDO_OL	R	0h	Internal VBAT1S LDO Over Load 0b = No Interrupt 1b = Interrupt
0	IR_PUVLO	R	0h	PVDD UVLO 0b = No Interrupt 1b = Interrupt

### 8.9.77 INT\_LTCH3 (page=0x00 address=0x50) [reset=00h]

Bit	Field	Type	Reset	Description
7	IR_TDTH2	R	0h	Thermal Detection Threshold 2 0b = No interrupt 1b = Interrupt
6	IR_TDTH1	R	0h	Thermal Detection Threshold 1 0b = No interrupt 1b = Interrupt
5	IR_PVBT	R	0h	Interrupt due to PVDD-VBAT1S going below the threshold 0b = No interrupt 1b = Interrupt
4	IR_BOPA	R	0h	BOP active flag 0b = No interrupt 1b = Interrupt
3	IR_BOPL3A	R	0h	BOP level 3 detected sticky 0b = No interrupt 1b = Interrupt
2	IR_BOPL2A	R	0h	BOP level 2 detected sticky 0b = No interrupt 1b = Interrupt
1	IR_BOPL1A	R	0h	BOP level 1 detected sticky 0b = No interrupt 1b = Interrupt
0	IR_BOPL0A	R	0h	BOP level 0 detected sticky 0b = No interrupt 1b = Interrupt

### 8.9.78 INT\_LTCH4 (page=0x00 address=0x51) [reset=00h]

Bit	Field	Type	Reset	Description
7-3	Reserved	R	0h	Reserved
2	IR_TDMCEIR	R	0h	TDM clock error type = Invalid SBCLK ratio or FS rate 0b = Not detected during TDM clock error 1b = Detected during TDM clock error
1	IR_TDMCEFC	R	0h	TDM clock error type = FS changed on the fly 0b = Detected during TDM clock error 1b = Not detected during TDM clock error
0	IR_TDMCERC	R	0h	TDM clock error type = SBCLK FS ratio changed on the fly 0b = Not detected during TDM clock error 1b = Detected during TDM clock error

### 8.9.79 VBAT\_MSB (page=0x00 address=0x52) [reset=00h]

Bit	Field	Type	Reset	Description
7-0	VBAT1S_CNV[11:4]	R	0h	Returns SAR ADC VBAT1S conversio: VBAT1S=[hex2dec(VBAT1S_CNV<11:0>)]/128

### 8.9.80 VBAT\_LSB (page=0x00 address=0x53) [reset=00h]

Bit	Field	Type	Reset	Description
7-4	VBAT1S_CNV[3:0]	R	0h	Returns SAR ADC VBAT1S conversio: VBAT1S=[hex2dec(VBAT1S_CNV<11:0>)]/128
3-0	Reserved	R	0h	Reserved



**8.9.81 PVDD\_MSB (page=0x00 address=0x54) [reset=00h]**

Bit	Field	Type	Reset	Description
7-0	PVDD_CNV[11:4]	R	0h	Returns SAR ADC PVDD conversio: PVDD=[hex2dec(PVDD_CNV<11:0>)]/128

**8.9.82 PVDD\_LSB (page=0x00 address=0x55) [reset=00h]**

Bit	Field	Type	Reset	Description
7-4	PVDD_CNV[3:0]	R	0h	Returns SAR ADC PVDD conversio: PVDD=[hex2dec(PVDD_CNV<11:0>)]/128
3-0	Reserved	R	0h	Reserved

**8.9.83 TEMP (page=0x00 address=0x56) [reset=00h]**

Bit	Field	Type	Reset	Description
7-0	TMP_CNV[7:0]	R	0h	Returns SAR ADC temp sensor conversion: TEMP( <sup>0</sup> C)=[hex2dec(TEMP_CNV(7:0))-93

**8.9.84 INT\_CLK\_CFG (page=0x00 address=0x5C) [reset=19h]**

Bit	Field	Type	Reset	Description
7	*CLK_ERR_PWR_EN	RW	0h	Clock based device power up/power down feature enable 0b = Enable clk halt detection after clock error detection 1b = Disable clock halt detection, after clock error is detected
6	*DIS_CLK_HALT	RW	0h	Clock halt timer enable 0b = Feature disabled 1b = Feature enabled
5-3	CLK_HALT_TIMER[2:0]	RW	3h	Clock halt timer values 0b = 820 us 1b = 3.27ms 2b = 26.21ms 3b =52.42ms 4b = 104.85ms 5b = 209.71ms 6b = 419.43ms 7b = 838.86 ms
2	IRQZ_CLR	RW	0h	Clear INT_LATCH registers 0b = Don't clear 1b = Clear (self clearing bit)
1-0	IRQZ_PIN_CFG[1:0]	RW	1h	IRQZ interrupt configuration. IRQZ will assert 00b = On any unmasked live interrupts 01b = On any unmasked latched interrupts 10b = For 2-4ms one time on any unmasked live interrupt event 11b = For 2-4ms every 4ms on any unmasked latched interrupts

\* Certain limitations applied. Contact TI if need to use this bit.

**8.9.85 MISC\_CFG3 (page=0x00 address=0x5D) [reset=80h]**

Bit	Field	Type	Reset	Description
7	IRQZ_POL	RW	1h	IRQZ pin polarity for interrupt. 0b = Active high 1b = Active low
6-4	Reserved	RW	0h	Reserved

Bit	Field	Type	Reset	Description
3-2	YB_BOP_CTRL	RW	0h	This register selects on which BOP level, Y-bridge and BYP_EN pad need to shift to PVDD when PVDD_SELECTION = 0. 0h = Shift to PVDD when BOP LVL0 is detected 1h = Shift to PVDD when BOP LVL1 or LVL0 is detected 2h = Shift to PVDD when BOP LVL2 or LVL1 or LVL0 is detected 3h = Shift to PVDD when BOP LVL3 or LVL2 or LVL1 or LVL0 is detected
1	Reserved	RW	0h	Reserved
0		R	0h	Reserved

**8.9.86 CLOCK\_CFG (page=0x00 address=0x60) [reset=0Dh]**

Bit	Field	Type	Reset	Description
7-6	Reserved	R	0h	Reserved
5-2	SAMP_RATIO[3:0]	RW	3h	SBCLK to FS ratio when AUTO_RATE=1 (disabled) 00h = 16 01h = 24 02h = 32 03h = 48 04h = 64 05h = 96 06h = 128 07h = 192 08h = 256 09h = 384 0Ah = 512 0Bh = 125 0Ch = 250 0Dh = 500 0Eh-0Fh = Reserved
1-0	Reserved	RW	1h	Reserved

**8.9.87 IDLE\_IND (page=0x00 address=0x63) [reset=48]**

Bit	Field	Type	Reset	Description
7	IDLE_IND	RW	0h	Idle channel Class D output current optimization 0b = Used for inductors 15uH and higher 1b = Used for 5uH inductors
6-0	Reserved	RW	48h	Reserved

**8.9.88 MISC\_CFG4 (page=0x00 address=0x65) [reset=08]**

Bit	Field	Type	Reset	Description
7-4	Reserved	RW	0h	Reserved
3	LDG_CLK	RW	1h	Clock source for load diagnostic 0b = External TDM 1b = Internal oscillator
2-1	LDG_IVSNS_AVG		0h	Duration on averaging on V/I data 0h = 5 ms 1h = 10 ms 2h = 50 ms 3h = 100 ms
0	Reserved	RW	0h	Reserved

**8.9.89 TG\_CFG0 (page=0x00 address=0x67) [reset=00h]**

Bit	Field	Type	Reset	Description
7-2	Reserved	R	0h	Reserved

Bit	Field	Type	Reset	Description
1-0	ID_CH_HYST_TIME[1:0]	RW	0h	Idle channel hysteresis timer. 00h = 50 ms 01h = 100 ms 02h = 200 ms 03h = 1000 ms

**8.9.90 CLK\_CFG (page=0x00 address=0x68) [reset=7Fh]**

Bit	Field	Type	Reset	Description
7	Reserved	R	0h	Reserved
6-3	FS_RATIO[3:0]	R	Fh	Detected SBCLK to FSYNC ratio. 00h = 16 01h = 24 02h = 32 03h = 48 04h = 64 05h = 96 06h = 128 07h = 192 08h = 256 09h = 384 0Ah = 512 0Bh = 125 0Ch = 250 0Dh = 500 0Eh = Reserved 0F = Invalid ratio
2-0	FS_RATE[2:0]	R	7h	Detected sample rate of TDM bus. 000b = Reserved 001b = Reserved 010b = Reserved 011b = Reserved 100b = 44.1/48 kHz 101b = 88.2/96 kHz 110b = Reserved 111b = Error condition

**8.9.91 LV\_EN\_CFG (page=0x00 address=0x6A) [reset=12h]**

Bit	Field	Type	Reset	Description
7-6	CDS_DLY[1:0]	RW	0h	Delay ( $1/f_s$ ) of the Class-D Y-bridge switching with respect to the input signal 00b = 8.1(NG enabled,48ksp), 6.1(NG disabled,48ksp) 00b = 12.6(NG enabled,96ksp), 9.6(NG disabled,96ksp) 01b = 7.1(NG enabled,48ksp), 5.1(NG disabled,48ksp), 01b = 10.6(NG enabled,96ksp), 7.6(NG disabled,96ksp) 10b = 6.1(NG enabled,48ksp), 4.1(NG disabled,48ksp) 10b = 8.5(NG enabled,96ksp), 5.6(NG disabled,96ksp) 11b = 5.6(NG enabled,48ksp), 3.6(NG disabled,48ksp) 11b = 7.6(NG enabled,96ksp), 4.6(NG disabled,96ksp)
5-4	LVS_DLY[1:0]	RW	1h	Delay ( $1/f_s$ ) of the BYP_EN signaling with respect to the input signal 00b = 7.8(NG enabled,48ksp), 5.8(NG disabled,48ksp) 00b = 12.1(NG enabled,96ksp), 9.1(NG disabled,96ksp) 01b = 6.8(NG enabled,48ksp), 4.8(NG disabled,48ksp), 01b = 10.1(NG enabled,96ksp), 7.1(NG disabled,96ksp) 10b = 5.8(NG enabled,48ksp), 3.8(NG disabled,48ksp) 10b = 8.1(NG enabled,96ksp), 5.1(NG disabled,96ksp) 11b = 5.1(NG enabled,48ksp), 3.1(NG disabled,48ksp) 11b = 6.6(NG enabled,96ksp), 3.6(NG disabled,96ksp)

Bit	Field	Type	Reset	Description
3-0	LVS_RTH[3:0]	RW	2h	Relative threshold for Low-Voltage Signaling. Headroom is from current VBAT1S voltage. 00h = 0.5 V 01h = 0.6 V 02h = 0.7 V ... 0Eh = 1.9 V 0Fh = 2 V

**8.9.92 NG\_CFG2 (page=0x00 address=0x6B) [reset=01h]**

Bit	Field	Type	Reset	Description
7	Reserved	R	0h	Reserved
6	CONV_VBAT_PVDD_MODE	RW	0h	Convert the VBAT1S in PVDD Only Mode 0b=No VBAT1S conversion 1b=VBAT1S conversion will show the value of internal LDO supplying VBAT1S pin
5-3	Reserved	R	0h	Reserved
2	NGFR_EN	RW	0h	Noise-gate fine resolution register mode 0b = Disabled 1b = Enabled
1-0	Reserved	RW	1h	Reserved

**8.9.93 NG\_CFG3 (page=0x00 address=0x6C) [reset=00h]**

 Programmable bits for Noise Gate fine resolution threshold to a level **-NGLVL**(dBFS)

Bit	Field	Type	Reset	Description
7-0	NGFR_LVL[23:16]	RW	0h	dec2hex{round{ 10 <sup>^</sup> (-NGLVL)/20}}*2 <sup>^</sup> 23}

**8.9.94 NG\_CFG4 (page=0x00 address=0x6D) [reset=00h]**

 Programmable bits for Noise Gate fine resolution threshold to a level **-NGLVL**(dBFS)

Bit	Field	Type	Reset	Description
7-0	NGFR_LVL[15:8]	RW	0h	dec2hex{round{ 10 <sup>^</sup> (-NGLVL)/20}}*2 <sup>^</sup> 23}

**8.9.95 NG\_CFG5 (page=0x00 address=0x6E) [reset=1Ah]**

 Programmable bits for Noise Gate fine resolution threshold to a level **-NGLVL**(dBFS)

Bit	Field	Type	Reset	Description
7-0	NGFR_LVL[7:0]	RW	1Ah	dec2hex{round{ 10 <sup>^</sup> (-NGLVL)/20}}*2 <sup>^</sup> 23}

**8.9.96 NG\_CFG6 (page=0x00 address=0x6F) [reset=00h]**

 Programmable bits for Noise Gate fine resolution threshold to a level **-NGLVL**(dBFS)

LEGEND: R/W = Read/Write; R = Read only; -n = value after reset

**Table 8-8. Noise Gate 6 Field Descriptions**

Bit	Field	Type	Reset	Description
7-0	NGFR_HYST[18:11]	RW	0h	dec2bin[(NGHYS*f <sub>s</sub> ),19] f <sub>s</sub> =sampling rate in kHz

**8.9.97 NG\_CFG7 (page=0x00 address=0x70) [reset=96h]**

 Programmable bits for Noise Gate fine resolution threshold to a level **-NGLVL**(dBFS)

LEGEND: R/W = Read/Write; R = Read only; -n = value after reset

**Table 8-9. Noise Gate 7 Field Descriptions**

Bit	Field	Type	Reset	Description
7-0	NGFR_HYST[10:3]	RW	96h	dec2bin[(NGHYS*f <sub>s</sub> ),19] f <sub>s</sub> =sampling rate in kHz

**Example**

NGFR\_HYST[15:0] is the result of 19 bits processing with last three bits thrown away (000)

For 50 ms and 48ksps formula is: dec2bin[50\*48,19]=dec2bin[2400,19]=0000000100101100000

Result: 01h in register 0x6F and 2Ch in register 0x70.

**8.9.98 PVDD\_UVLO (page=0x00 address=0x71) [reset=00h]**

Bit	Field	Type	Reset	Description
7-6	Reserved	RW	00h	Reserved
5-0	PVDD_UVLO_TH[5:0]	RW	00h	PVDD UVLO Thresholds. 00h = 2.2 V 01h = 2.419 V 02h = 2.638 V ..... 3Fh = 16 V

**8.9.99 DAC\_MOD\_RST (page=0x00 address=0x76) [reset=02h]**

Bit	Field	Type	Reset	Description
7-2	Reserved	RW	0h	Reserved
1	DIS_DMOD_RST	RW	1h	Reset of DAC Modulator when DSP is OFF: 0= Enable reset of DAC Modulator when DSP is OFF 1= Disable reset of DAC Modulator when DSP is OFF
0	Reserved	R	0h	Reserved <i>Reset value can change when read back .</i>

**8.9.100 REV\_ID (page=0x00 address=0x7D) [reset=30h]**

Bit	Field	Type	Reset	Description
7-4	REV_ID[3:0]	R	3h	Returns the revision ID.
3-0	PG_ID[3:0]	R	0h	Returns the PG ID.

**8.9.101 I2C\_CKSUM (page=0x00 address=0x7E) [reset=00h]**

Bit	Field	Type	Reset	Description
7-0	I2C_CKSUM[7:0]	RW	0h	Returns I2C checksum. Writing to this register will reset the checksum to the written value. This register is updated on writes to other registers on all books and pages.

**8.9.102 BOOK (page=0x00 address=0x7F) [reset=00h]**

Bit	Field	Type	Reset	Description
7-0	BOOK[7:0]	RW	0h	Sets the device book. 00h = Book 0 01h = Book 1 ... FFh = Book 255

### 8.9.103 LSR (page=0x01 address=0x19) [reset=40h]

Bit	Field	Type	Reset	Description
7	Reserved	R	0b	Reserved
6	EN_LLSR	RW	1b	Modulation 0b = LSR 1b = Linear LSR
5-0	Reserved	R	0h	Reserved

### 8.9.104 SDOUT\_HIZ\_1 (page=0x01 address=0x3D) [reset=00h]

Bit	Field	Type	Reset	Description
7-0	SDOUT_HIZ1[7:0]	RW	0h	Force '0' output control for slots 7 down to 0. This register to be programmed as zero in case the slot is not valid as per valid FSRATIO

### 8.9.105 SDOUT\_HIZ\_2 (page=0x01 address=0x3E) [reset=00h]

Bit	Field	Type	Reset	Description
7-0	SDOUT_HIZ2[7:0]	RW	0h	Force '0' output control for slots 15 down to 8. This register to be programmed as zero in case the slot is not valid as per valid FSRATIO

### 8.9.106 SDOUT\_HIZ\_3 (page=0x01 address=0x3F) [reset=00h]

Bit	Field	Type	Reset	Description
7-0	SDOUT_HIZ3[7:0]	RW	0h	Force '0' output control for slots 23 down to 16. This register to be programmed as zero in case the slot is not valid as per valid FSRATIO

### 8.9.107 SDOUT\_HIZ\_4 (page=0x01 address=0x40) [reset=00h]

Bit	Field	Type	Reset	Description
7-0	SDOUT_HIZ4[7:0]	RW	0h	Force '0' output control for slots 31 down to 24. This register to be programmed as zero in case the slot is not valid as per valid FSRATIO

### 8.9.108 SDOUT\_HIZ\_5 (page=0x01 address=0x41) [reset=00h]

Bit	Field	Type	Reset	Description
7-0	SDOUT_HIZ5[7:0]	RW	0h	Force '0' output control for slots 39 down to 32. This register to be programmed as zero in case the slot is not valid as per valid FSRATIO

### 8.9.109 SDOUT\_HIZ\_6 (page=0x01 address=0x42) [reset=00h]

Bit	Field	Type	Reset	Description
7-0	SDOUT_HIZ6[7:0]	RW	0h	Force '0' output control for slots 47 down to 40. This register to be programmed as zero in case the slot is not valid as per valid FSRATIO

### 8.9.110 SDOUT\_HIZ\_7 (page=0x01 address=0x43) [reset=00h]

Bit	Field	Type	Reset	Description
7-0	SDOUT_HIZ7[7:0]	RW	0h	Force '0' output control for slots 55 down to 48. This register to be programmed as zero in case the slot is not valid as per valid FSRATIO

**8.9.111 SDOUT\_HIZ\_8 (page=0x01 address=0x44) [reset=00h]**

Bit	Field	Type	Reset	Description
7-0	SDOUT_HIZ8[7:0]	RW	0h	Force '0' output control for slots 63 down to 56. This register to be programmed as zero in case the slot is not valid as per valid FSRATIO

**8.9.112 SDOUT\_HIZ\_9 (page=0x01 address=0x45) [reset=00h]**

Bit	Field	Type	Reset	Description
7	SDOUT_FORCE_0_CNT_EN	RW	0h	Control over sending "0" to un-used slots 0b = All unused slots will have 'Hi-Z' transmitted 1b = Unused slots can transmit '0' base on programming in registers 0x44 to 0x3D
6-0	Reserved	RW	0h	Reserved

**8.9.113 TG\_EN (page=0x01 address=0x47) [reset=ABh]**

Bit	Field	Type	Reset	Description
7-2	Reserved	R	6'b101010	Reserved <i>Reset value can change when read back .</i>
1	TG_TH2	RW	1'b1	Thermal threshold 2 1=Enabled 0=Disabled
0	TG_TH1	RW	1'b1	Thermal threshold 1 1=Enabled 0=Disabled

**8.9.114 DG\_DC\_VAL1 (page=0x04 address=0x08) [reset=40h]**

Programmable Diagnostic bits for a **DC\_VAL** (dBFS) desired level.

Bit	Field	Type	Reset	Description
7-0	DG_DC_VAL [31:24]	RW	40h	dec2hex{256*round[10 <sup>(DC_VAL/20)</sup> *2 <sup>23</sup> ]}

**8.9.115 DG\_DC\_VAL2 (page=0x04 address=0x09) [reset=26h]**

Programmable Diagnostic bits for a **DC\_VAL** (dBFS) desired level.

Bit	Field	Type	Reset	Description
7-0	DG_DC_VAL [23:16]	RW	26h	dec2hex{256*round[10 <sup>(DC_VAL/20)</sup> *2 <sup>23</sup> ]}

**8.9.116 DG\_DC\_VAL3 (page=0x04 address=0x0A) [reset=40h]**

Bit	Field	Type	Reset	Description
7-0	DG_DC_VAL [15:8]	RW	40h	dec2hex{256*round[10 <sup>(DC_VAL/20)</sup> *2 <sup>23</sup> ]}

**8.9.117 DC\_DG\_VAL4 (page=0x04 address=0x0B) [reset=00h]**

Programmable Diagnostic bits for a **DC\_VAL** (dBFS) desired level.

Bit	Field	Type	Reset	Description
7-0	DG_DC_VAL [7:0]	RW	00h	dec2hex{256*round[10 <sup>(DC_VAL/20)</sup> *2 <sup>23</sup> ]}

**8.9.118 LIM\_TH\_MAX1 (page=0x04 address=0x0C) [reset=68h]**

Programmable bits to set limiter maximum threshold to a **LIM\_TH\_MAX** (V).

Bit	Field	Type	Reset	Description
7-0	LIM_TH_MAX[31:24]	RW	68h	dec2hex{256*round [LIM_TH_MAX*2 <sup>19</sup> ]}

#### 8.9.119 LIM\_TH\_MAX2 (page=0x04 address=0x0D) [reset=00h]

Programmable bits to set limiter maximum threshold to a LIM\_TH\_MAX (V).

Bit	Field	Type	Reset	Description
7-0	LIM_TH_MAX[23:16]	RW	00h	dec2hex{256*round [LIM_TH_MAX*2 <sup>19</sup> ]}

#### 8.9.120 LIM\_TH\_MAX3 (page=0x04 address=0x0E) [reset=00h]

Programmable bits to set limiter maximum threshold to a LIM\_TH\_MAX (V).

Bit	Field	Type	Reset	Description
7-0	LIM_TH_MAX[15:8]	RW	00h	dec2hex{256*round [LIM_TH_MAX*2 <sup>19</sup> ]}

#### 8.9.121 LIM\_TH\_MAX4 (page=0x04 address=0x0F) [reset=00h]

Programmable bits to set limiter maximum threshold to a LIM\_TH\_MAX (V).

Bit	Field	Type	Reset	Description
7-0	LIM_TH_MAX[7:0]	RW	00h	dec2hex{256*round [LIM_TH_MAX*2 <sup>19</sup> ]}

#### 8.9.122 LIM\_TH\_MIN1 (page=0x04 address=0x10) [reset=28h]

Sets limiter minimum threshold to a LIM\_TH\_MIN (V) value.

Bit	Field	Type	Reset	Description
7-0	LIM_TH_MIN[31:24]	RW	28h	dec2hex{256*round [LIM_TH_MIN*2 <sup>19</sup> ]}

#### 8.9.123 LIM\_TH\_MIN2 (page=0x04 address=0x11) [reset=00h]

Sets limiter minimum threshold to a LIM\_TH\_MIN (V) value.

Bit	Field	Type	Reset	Description
7-0	LIM_TH_MIN[23:16]	RW	00h	dec2hex{256*round [LIM_TH_MIN*2 <sup>19</sup> ]}

#### 8.9.124 LIM\_TH\_MIN3 (page=0x04 address=0x12) [reset=00h]

Sets limiter minimum threshold to a LIM\_TH\_MIN (V) value.

Bit	Field	Type	Reset	Description
7-0	LIM_TH_MIN[15:8]	RW	00h	dec2hex{256*round [LIM_TH_MIN*2 <sup>19</sup> ]}

#### 8.9.125 LIM\_TH\_MIN4 (page=0x04 address=0x13) [reset=00h]

Sets limiter minimum threshold to a LIM\_TH\_MIN (V) value.

Bit	Field	Type	Reset	Description
7-0	LIM_TH_MIN[7:0]	RW	0h	dec2hex{256*round [LIM_TH_MIN*2 <sup>19</sup> ]}

#### 8.9.126 LIM\_INF\_PT1 (page=0x04 address=0x14) [reset=56h]

Sets limiter inflection point to a value of LIM\_INF\_PT (V).

Bit	Field	Type	Reset	Description
7-0	LIM_INF_PT[31:24]	RW	56h	dec2hex{256*round [LIM_INF_PT*2 <sup>19</sup> ]}



### 8.9.127 LIM\_INF\_PT2 (page=0x04 address=0x15) [reset=66h]

Sets limiter inflection point to a value of **LIM\_INF\_PT** (V).

Bit	Field	Type	Reset	Description
7-0	LIM_INF_PT[23:16]	RW	66h	dec2hex{256*round [LIM_INF_PT*2 <sup>19</sup> ]}

### 8.9.128 LIM\_INF\_PT3 (page=0x04 address=0x16) [reset=66h]

Sets limiter inflection point to a value of **LIM\_INF\_PT** (V).

Bit	Field	Type	Reset	Description
7-0	LIM_INF_PT[15:8]	RW	66h	dec2hex{256*round [LIM_INF_PT*2 <sup>19</sup> ]}

### 8.9.129 LIM\_INF\_PT4 (page=0x04 address=0x17) [reset=00h]

Sets limiter inflection point to a value of **LIM\_INF\_PT** (V).

Bit	Field	Type	Reset	Description
7-0	LIM_INF_PT[7:0]	RW	0h	dec2hex{256*round [LIM_INF_PT*2 <sup>19</sup> ]}

### 8.9.130 LIM\_SLOPE1 (page=0x04 address=0x18) [reset=10h]

Sets limiter slope to a **LIM\_SLOPE** (V) value.

Bit	Field	Type	Reset	Description
7-0	LIM_SLOPE[31:24]	RW	10h	dec2hex{256*round [LIM_SLOPE*2 <sup>20</sup> ]}

### 8.9.131 LIM\_SLOPE2 (page=0x04 address=0x19) [reset=00h]

Sets limiter slope to a **LIM\_SLOPE** (V) value.

Bit	Field	Type	Reset	Description
7-0	LIM_SLOPE[23:16]	RW	00h	dec2hex{256*round [LIM_SLOPE*2 <sup>20</sup> ]}

### 8.9.132 LIM\_SLOPE3 (page=0x04 address=0x1A) [reset=00h]

Sets limiter slope to a **LIM\_SLOPE** (V) value.

Bit	Field	Type	Reset	Description
7-0	LIM_SLOPE[15:8]	RW	00h	dec2hex{256*round [LIM_SLOPE*2 <sup>20</sup> ]}

### 8.9.133 LIM\_SLOPE4 (page=0x04 address=0x1B) [reset=00h]

Sets limiter slope to a **LIM\_SLOPE** (V) value.

Bit	Field	Type	Reset	Description
7-0	LIM_SLOPE[7:0]	RW	00h	dec2hex{256*round [LIM_SLOPE*2 <sup>20</sup> ]}

### 8.9.134 TF\_HLD1 (page=0x04 address=0x1C) [reset=00h]

Thermal fold-back hold count set to a **TF\_HLD** (s) value.

Bit	Field	Type	Reset	Description
7-0	TF_HOLD_CNT[31:24]	RW	00h	dec2hex [256*round (TF_HLD*9600)]

### 8.9.135 TF\_HLD2 (page=0x04 address=0x1D) [reset=03h]

Thermal fold-back hold count set to a **TF\_HLD** (s) value.

Bit	Field	Type	Reset	Description
7-0	TF_HOLD_CNT[23:16]	RW	03h	dec2hex [256*round (TF_HLD*9600)]

### 8.9.136 TF\_HLD3 (page=0x04 address=0x1E) [reset=E8h]

Thermal fold-back hold count set to a **TF\_HLD** (s) value.

Bit	Field	Type	Reset	Description
7-0	TF_HOLD_CNT[15:8]	RW	E8h	dec2hex [256*round (TF_HLD*9600)]

### 8.9.137 TF\_HLD4 (page=0x04 address=0x1F) [reset=00h]

Thermal fold-back hold count set to a **TF\_HLD** (s) value.

Bit	Field	Type	Reset	Description
7-0	TF_HOLD_CNT[7:0]	RW	00h	dec2hex [256*round (TF_HLD*9600)]

### 8.9.138 TF\_RLS1 (page=0x04 address=0x20) [reset=40h]

Thermal fold-back limiter release rate set to a value **TF\_RLS** (dB/100us).

Bit	Field	Type	Reset	Description
7-0	TF_REL_RATE[31:24]	RW	40h	dec2hex{256*round[10^(TF_RLS/20)*2^22]}

### 8.9.139 TF\_RLS2 (page=0x04 address=0x21) [reset=12h]

Thermal fold-back limiter release rate set to a value **TF\_RLS** (dB/100us).

Bit	Field	Type	Reset	Description
7-0	TF_REL_RATE[23:16]	RW	12h	dec2hex{256*round[10^(TF_RLS/20)*2^22]}

### 8.9.140 TF\_RLS3 (page=0x04 address=0x22) [reset=E0h]

Thermal fold-back limiter release rate set to a value **TF\_RLS** (dB/100us).

Bit	Field	Type	Reset	Description
7-0	TF_REL_RATE[15:8]	RW	E0h	dec2hex{256*round[10^(TF_RLS/20)*2^22]}

### 8.9.141 TF\_RLS4 (page=0x04 address=0x23) [reset=00h]

Thermal fold-back limiter release rate set to a value **TF\_RLS** (dB/100us).

Bit	Field	Type	Reset	Description
7-0	TF_REL_RATE[7:0]	RW	0h	dec2hex{256*round[10^(TF_RLS/20)*2^22]}

### 8.9.142 TF\_SLOPE1 (page=0x04 address=0x24) [reset=04h]

Thermal fold-back limiter attenuation slope set to a value **TF\_SLOPE** (V/°C).

Input level is assumed 0dB and gain is 21dB. Extra 3dB (from 24dB) is due to rms to peak conversion.

Bit	Field	Type	Reset	Description
7-0	TF_LIMS[31:24]	RW	04h	dec2hex {256*round[TF_SLOPE/10^(24/20)]*2^23}

### 8.9.143 TF\_SLOPE2 (page=0x04 address=0x25) [reset=08h]

Thermal fold-back limiter attenuation slope set to a value **TF\_SLOPE** (V/°C).

Input level is assumed 0dB and gain is 21dB. Extra 3dB (from 24dB) is due to rms to peak conversion.

Bit	Field	Type	Reset	Description
7-0	TF_LIMS[23:16]	RW	08h	dec2hex {256*round[TF_SLOPE/10^(24/20)]*2^23}

#### 8.9.144 TF\_SLOPE3 (page=0x04 address=0x26) [reset=89h]

Thermal fold-back limiter attenuation slope set to a value **TF\_SLOPE** (V/°C).

Input level is assumed 0dB and gain is 21dB. Extra 3dB (from 24dB) is due to rms to peak conversion.

Bit	Field	Type	Reset	Description
7-0	TF_LIMS[15:8]	RW	89h	dec2hex {256*round[TF_SLOPE/10^(24/20)]*2^23}

#### 8.9.145 TF\_SLOPE4 (page=0x04 address=0x27) [reset=00h]

Thermal fold-back limiter attenuation slope set to a value **TF\_SLOPE** (V/°C).

Input level is assumed 0dB and gain is 21dB. Extra 3dB (from 24dB) is due to rms to peak conversion.

Bit	Field	Type	Reset	Description
7-0	TF_LIMS[7:0]	RW	0h	dec2hex {256*round[TF_SLOPE/10^(24/20)]*2^23}

#### 8.9.146 TF\_TEMP\_TH1 (page=0x04 address=0x28) [reset=39h]

Thermal fold-back temperature threshold set to **TF\_TEMP** (°C) value.

Bit	Field	Type	Reset	Description
7-0	TF_TEMP_TH[31:24]	RW	39h	dec2hex{256*round[TF_TEMP*(2^15)]}

#### 8.9.147 TF\_TEMP\_TH2 (page=0x04 address=0x29) [reset=80h]

Thermal fold-back temperature threshold set to **TF\_TEMP** (°C) value.

Bit	Field	Type	Reset	Description
7-0	TF_TEMP_TH[23:16]	RW	80h	dec2hex{256*round[TF_TEMP*(2^15)]}

#### 8.9.148 TF\_TEMP\_TH3 (page=0x04 address=0x2A) [reset=00h]

Thermal fold-back temperature threshold set to **TF\_TEMP** (°C) value.

Bit	Field	Type	Reset	Description
7-0	TF_TEMP_TH[15:8]	RW	00h	dec2hex{256*round[TF_TEMP*(2^15)]}

#### 8.9.149 TF\_TEMP\_TH4 (page=0x04 address=0x2B) [reset=00h]

Thermal fold-back temperature threshold set to **TF\_TEMP** (°C) value.

Bit	Field	Type	Reset	Description
7-0	TF_TEMP_TH[7:0]	RW	00h	dec2hex{256*round[TF_TEMP*(2^15)]}

#### 8.9.150 TF\_MAX\_ATT1 (page=0x04 address=0x2C) [reset=2Dh]

Thermal fold-back maximum gain reduction set to **TF\_ATT1** (dB) value.

Bit	Field	Type	Reset	Description
7-0	TF_MAX_ATT1[31:24]	RW	2Dh	dec2hex{256*round[10^(-TF_ATT1/20)*2^23]}

#### 8.9.151 TF\_MAX\_ATT2 (page=0x04 address=0x2D) [reset=6Ah]

Thermal fold-back maximum gain reduction set to **TF\_ATT2** (dB) value.

Bit	Field	Type	Reset	Description
7-0	TF_MAX_ATTEN[23:16]	RW	6Ah	dec2hex{256*round[10 <sup>^</sup> (-TF_ATTEN/20)*2 <sup>^</sup> 23]}

### 8.9.152 TF\_MAX\_ATTEN3 (page=0x04 address=0x2E) [reset=86h]

Thermal fold-back maximum gain reduction set to **TF\_ATTEN** (dB) value.

Bit	Field	Type	Reset	Description
7-0	TF_MAX_ATTEN[15:8]	RW	86h	dec2hex{256*round[10 <sup>^</sup> (-TF_ATTEN/20)*2 <sup>^</sup> 23]}

### 8.9.153 TF\_MAX\_ATTEN4 (page=0x04 address=0x2F) [reset=00h]

Thermal fold-back maximum gain reduction set to **TF\_ATTEN** (dB) value.

Bit	Field	Type	Reset	Description
7-0	TF_MAX_ATTEN[7:0]	RW	0h	dec2hex{256*round[10 <sup>^</sup> (-TF_ATTEN/20)*2 <sup>^</sup> 23]}

### 8.9.154 LD\_CFG0 (page=0x04 address=0x40) [reset=02h]

Load diagnostic resistance upper threshold value set to **LDG\_RES\_UT** ( $\Omega$ ).

Bit	Field	Type	Reset	Description
7-0	LDG_RES_UT[31:24]	RW	02h	dec2hex {256*round[LDG_RES_UT*(3.75/14)*2 <sup>^</sup> 14]}

### 8.9.155 LD\_CFG1 (page=0x04 address=0x41) [reset=ADh]

Load diagnostic resistance upper threshold value set to **LDG\_RES\_UT** ( $\Omega$ ).

Bit	Field	Type	Reset	Description
7-0	LDG_RES_UT[23:16]	RW	ADh	dec2hex {256*round[LDG_RES_UT*(3.75/14)*2 <sup>^</sup> 14]}

### 8.9.156 LD\_CFG2 (page=0x04 address=0x42) [reset=B7h]

Load diagnostic resistance upper threshold value set to **LDG\_RES\_UT** ( $\Omega$ ).

Bit	Field	Type	Reset	Description
7-0	LDG_RES_UT[15:8]	RW	B7h	dec2hex {256*round[LDG_RES_UT*(3.75/14)*2 <sup>^</sup> 14]}

### 8.9.157 LD\_CFG3 (page=0x04 address=0x43) [reset=00h]

Load diagnostic resistance upper threshold value set to **LDG\_RES\_UT** ( $\Omega$ ).

Bit	Field	Type	Reset	Description
7-0	LDG_RES_UT[7:0]	RW	0h	dec2hex {256*round[LDG_RES_UT*(3.75/14)*2 <sup>^</sup> 14]}

### 8.9.158 LD\_CFG4 (page=0x04 address=0x44) [reset=00h]

Load diagnostics resistance lower threshold value set to **LDG\_RES\_LT** ( $\Omega$ ).

Bit	Field	Type	Reset	Description
7-0	LDG_RES_LT[31:24]	RW	0h	dec2hex {256*round[LDG_RES_LT*(3.75/14)*2 <sup>^</sup> 14]}

### 8.9.159 LD\_CFG5 (page=0x04 address=0x45) [reset=1Bh]

Load diagnostics resistance lower threshold value set to **LDG\_RES\_LT** ( $\Omega$ ).

Bit	Field	Type	Reset	Description
7-0	LDG_RES_LT[23:16]	RW	1Bh	dec2hex {256*round[LDG_RES_LT*(3.75/14)*2 <sup>^</sup> 14]}

**8.9.160 LD\_CFG6 (page=0x04 address=0x46) [reset=6Eh]**

Load diagnostics resistance lower threshold value set to **LDG\_RES\_LT** ( $\Omega$ ).

Bit	Field	Type	Reset	Description
7-0	LDG_RES_LT[15:8]	RW	6Eh	dec2hex {256*round[LDG_RES_LT*(3.75/14)*2^14]}

**8.9.161 LD\_CFG7 (page=0x04 address=0x47) [reset=00h]**

Load diagnostics resistance lower threshold value set to **LDG\_RES\_LT** ( $\Omega$ ).

Bit	Field	Type	Reset	Description
7-0	LDG_RES_LT[7:0]	RW	0h	dec2hex {256*round[LDG_RES_LT*(3.75/14)*2^14]}

**8.9.162 CLD\_EFF\_1 (page=0x04 address=0x48) [reset=6Ch]**

Class D efficiency for LVS relative threshold expressed as a fraction (**EFF**). Default is 0.85.

Bit	Field	Type	Reset	Description
7-0	ClassD Efficiency [31:24]	RW	6Ch	dec2hex[256*round(EFF*2^23)]

**8.9.163 CLD\_EFF\_2 (page=0x04 address=0x49) [reset=CCh]**

Class D efficiency for LVS relative threshold expressed as a fraction (**EFF**). Default is 0.85.

Bit	Field	Type	Reset	Description
7-0	ClassD Efficiency [23:16]	RW	CCh	dec2hex[256*round(EFF*2^23)]

**8.9.164 CLD\_EFF\_3 (page=0x04 address=0x4A) [reset=CDh]**

Class D efficiency for LVS relative threshold expressed as a fraction (**EFF**). Default is 0.85.

Bit	Field	Type	Reset	Description
7-0	ClassD Efficiency [15:8]	RW	CDh	dec2hex[256*round(EFF*2^23)]

**8.9.165 CLD\_EFF\_4 (page=0x04 address=0x4B) [reset=00h]**

Class D efficiency for LVS relative threshold expressed as a fraction (**EFF**). Default is 0.85.

Bit	Field	Type	Reset	Description
7-0	ClassD Efficiency [7:0]	RW	00h	dec2hex[256*round(EFF*2^23)]

**8.9.166 LDG\_RES1 (page=0x04 address=0x4C) [reset=00h]**

Diagnostic Mode load resistance measured value in  $\Omega$ . Read value is **0xUUUVVXXYY** and the last byte to be dropped.

Bit	Field	Type	Reset	Description
7-0	LDG_RES_VAL[32:24]	R	0h	(14/3.75)*{[hex2dec(0xUUUVVXX)]/2^14}

**8.9.167 LDG\_RES2 (page=0x04 address=0x4D) [reset=00h]**

Diagnostic Mode load resistance measured value in  $\Omega$ . Read value is **0xUUUVVXXYY** and the last byte to be dropped.

Bit	Field	Type	Reset	Description
7-0	LDG_RES_VAL[23:16]	R	0h	(14/3.75)*{[hex2dec(0xUUUVVXX)]/2^14}

**8.9.168 LDG\_RES3 (page=0x04 address=0x4E) [reset=00h]**

Diagnostic Mode load resistance measured value in  $\Omega$ . Read value is **0xUUUVVXXYY** and the last byte to be dropped.

Bit	Field	Type	Reset	Description
7-0	LDG_RES_VAL[15:8]	R	0h	$(14/3.75) * \{\text{hex2dec}(0xUUUVVXX)\} / 2^{14}$

**8.9.169 LDG\_RES4 (page=0x04 address=0x4F) [reset=00h]**

Bit	Field	Type	Reset	Description
7-0	LDG_RES_VAL[7:0]	R	0h	Drop this byte.

**8.10 SDOUT Equations**

The following equations will allow to convert data read on SDOUT.

$$PVDD (V) = 16 * [\text{Hex2Dec}(\text{SDOUTdata})] / 2^{\text{PVDDSlotLength}}$$

By default, PVDDSlotLength=8.

$$VBAT (V) = 8 * [\text{Hex2Dec}(\text{SDOUTdata})] / 2^{\text{VBATSlotLength}}$$

By default, VBATSlotLength=8.

$$\text{TEMP } (^{\circ}\text{C}) = [\text{Hex2Dec}(\text{SDOUTdata})] - 93$$

## 9 Application and Implementation

### Note

Information in the following applications sections is not part of the TI component specification, and TI does not warrant its accuracy or completeness. TI's customers are responsible for determining suitability of components for their purposes. Customers should validate and test their design implementation to confirm system functionality.

### 9.1 Application Information

The TAS2764 is a digital input Class-D audio power amplifier with integrated current and voltage sense. I<sup>2</sup>S audio data is supplied by host processor. TAS2764 sends to the host processor current and voltage data in I<sup>2</sup>S format. I<sup>2</sup>C bus is used for configuration and control.

### 9.2 Typical Application

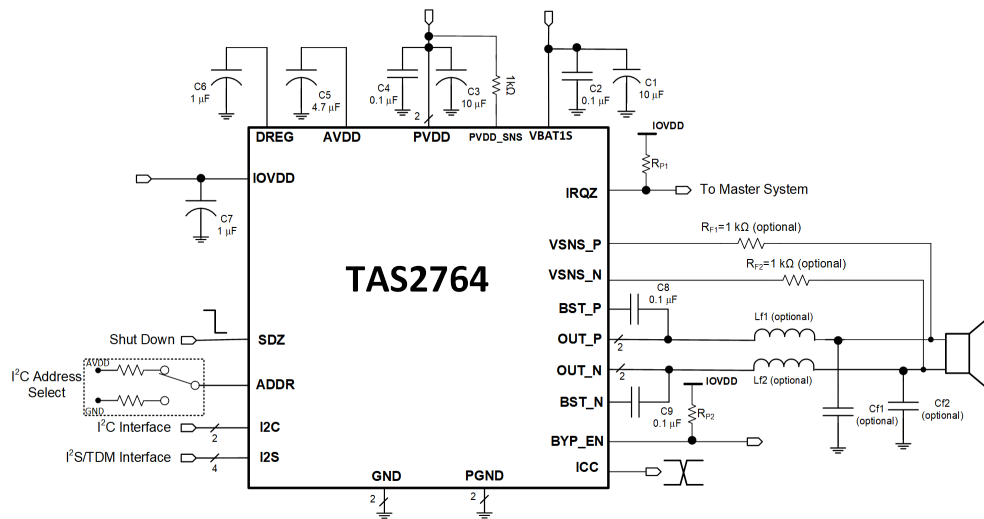


Figure 9-1. Typical Application - Digital Audio Input

Table 9-1. Recommended External Components

COMPONENT	DESCRIPTION	SPECIFICATION	MIN	TYP	MAX	UNIT
C1	VBAT1S Decoupling Capacitor - VBAT1S External Supply (PWR_MODE1)	Type	X7R			
		Capacitance, 20% Tolerance	10			μF
		Rated Voltage	6			V
	VBAT1S Decoupling Capacitor - VBAT1S Internally Generated (PWR_MODE2)	Type	X7R			
		Capacitance, 20% Tolerance	0.68	1	1.5	μF
		Rated Voltage	6			V
C2	VBAT1S Decoupling Capacitor	Type	X7R			
		Capacitance, 20% Tolerance		100		nF
		Rated Voltage	6			V
C3	PVDD Decoupling Capacitor	Type	X7R			
		Capacitance, 20% Tolerance	10			μF
		Rated Voltage	20			V
C4	PVDD Decoupling Capacitor	Type	X7R			
		Capacitance, 20% Tolerance		100		nF
		Rated Voltage	20			V
C5	AVDD Decoupling Capacitor	Type	X7R			
		Capacitance, 20% Tolerance	4.7			μF
		Rated Voltage	6			V

**Table 9-1. Recommended External Components (continued)**

COMPONENT	DESCRIPTION	SPECIFICATION	MIN	TYP	MAX	UNIT
C6	DREG Decoupling Capacitor	Type	X7R			
		Capacitance, 20% Tolerance	0.68	1	1.5	$\mu\text{F}$
		Rated Voltage	6			V
C7	IOVDD Decoupling Capacitor	Type	X7R			
		Capacitance, 20% Tolerance	1			$\mu\text{F}$
		Rated Voltage	6			V
C8, C9	High-side Boost Capacitors	Type	X7R			
		Capacitance, 20% Tolerance	68	100	150	nF
		Rated Voltage	6			V
Lf1, Lf2	EMI Filter Inductors (optional). These are not recommended as it degrades THD+N performance. The TAS2764 device is a filter-less Class-D and does not require these bead inductors.	Impedance at 100MHz		120		$\Omega$
		DC Resistance			0.095	$\Omega$
		DC Current	5			A
Cf1, Cf2	EMI Filter Capacitors (optional, must use Lf2, Lf3 if Cf1, Cf2 used)	Capacitance		1		nF
R <sub>F1</sub> , R <sub>F2</sub>	Feedback resistor to be connected if L <sub>f</sub> , C <sub>f</sub> filters are used		1	5		k $\Omega$
R <sub>P1</sub> , R <sub>P2</sub>	Pull up resistors to IOVDD	For minimum driving capability of 2mA	1	10		k $\Omega$

### 9.3 Design Requirements

For this design example, use the parameters shown in [Section 9.2](#).

**Table 9-2. Design Parameters**

DESIGN PARAMETER	EXAMPLE VALUE
Audio Input	Digital Audio, I <sup>2</sup> S
Current and Voltage Data Stream	Digital Audio, I <sup>2</sup> S
Mono or Stereo Configuration	Mono
Max Output Power at 1% THD+N, over temperature and frequency range, R <sub>L</sub> = 4 $\Omega$	$\geq 10$ W

### 9.4 Detailed Design Procedure

#### 9.4.1 Mono/Stereo Configuration

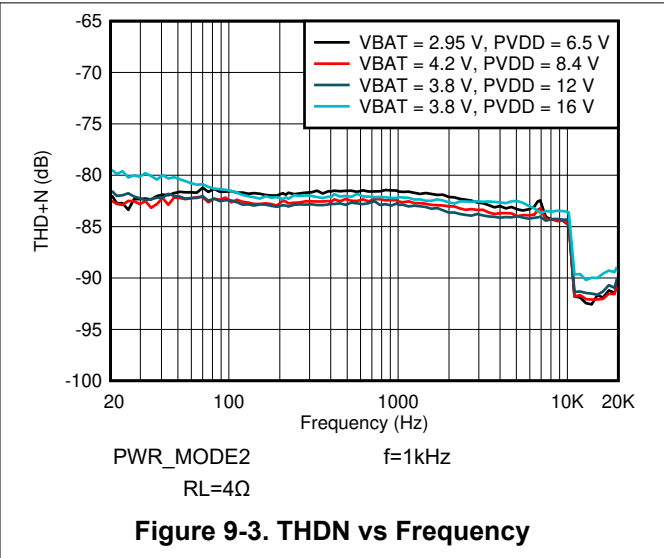
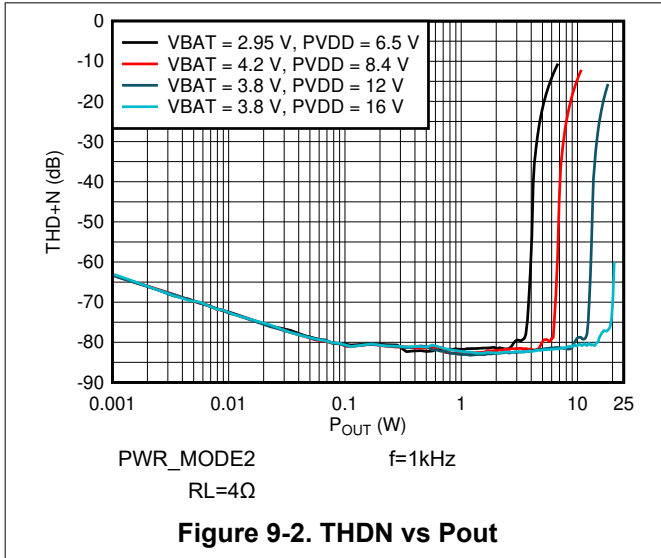
In this application, the device is assumed to be operating in mono mode. See [Section 8.3.1](#) for information on changing the I<sup>2</sup>C address of the TAS2764 to support stereo operation. Mono or stereo configuration does not impact the device performance.

#### 9.4.2 EMI Passive Devices

The TAS2764 supports spread spectrum to minimize EMI. It is allowed to include passive devices on the Class-D outputs. The passive devices Lf1, Lf2, Cf1 and Cf2 from [Figure 9-1](#) have recommended specifications provided in [Table 9-1](#). The passive devices Lf1, Lf2, Cf1 and Cf2 have to be properly selected to maintain the stability of the output stage. See [Section 8.4.5](#) for details.



## 9.5 Application Curves



## 10 Initialization Set Up

### 10.1 Recommended Configuration at Power Up

The following configuration is recommended after power up.

```

w 70 00 00 # Page-0
w 70 7F 00 # Book-0
w 70 01 01 # SW reset
d 1 # 1mS Delay
w 70 0E 44 # TDM TX voltage sense transmit enable with slot 4,
w 70 0F 40 # TDM TX current sense transmit enable with slot 0

w 70 00 00 # Page-0
w 70 7F 00 # Book-0
w 70 00 06 # Switch to Page-6
#250C # Write quadratic without additional TCO and ratio of 1.7
w 70 14 00 13 52 00 E4 0C AA 00 12 A0 D8 00
w 70 00 01 # Page-01
w 70 47 AA # Threshold-1 disabled
w 70 19 40 # Linear LSR mode
w 70 37 AA # Linear LSR deglitch disabled
w 70 33 80 # SAR reaction on noise gate

w 70 00 00 # Page-0
w 70 76 00 # DAC mod reset for reduced POP
w 70 02 00 # Power up audio playback with I,V enabled

```

### 10.2 Initial Device Configuration - 4 Channel Power Up (Default Mode - PWR\_MODE1)

The following I<sup>2</sup>C sequence is an example of initializing four TAS2764 devices. This sequence contains a 1 ms delay required after a software or hardware reset as illustrated in [Section 11](#).

```

##### Configure Channel 1
w 70 60 11 # sbclk to fs ratio = 64
w 70 0D 33 # TX bus keeper, Hi-Z, offset 1, TX on Falling edge
w 70 0E 42 # TDM TX voltage sense transmit enable with slot 2,
w 70 0F 40 # TDM TX current sense transmit enable with slot 0
w 70 03 14 # 21 dB gain
w 70 02 00 # power up audio playback with I,V enabled
##### Configure Channel 2
w 72 60 11 # sbclk to fs ratio = 64
w 72 0D 13 # TX bus keeper, Hi-Z, offset 1, TX on Falling edge
w 72 0E 46 # TDM TX voltage sense transmit enable with slot 6,
w 72 0F 44 # TDM TX current sense transmit enable with slot 4
w 72 03 14 # 21 dB gain
w 72 02 00 # power up audio playback with I,V enabled
##### Configure Channel 3
w 74 60 11 # sbclk to fs ratio = 64
w 74 0D 13 # TX bus keeper, Hi-Z, offset 1, TX on Falling edge
w 74 0E 4A # TDM TX voltage sense transmit enable with slot 10,
w 74 0F 48 # TDM TX current sense transmit enable with slot 8
w 74 03 14 # 21 dB gain
w 74 02 00 # power up audio playback with I,V enabled
##### Configure Channel 4
w 76 60 11 # sbclk to fs ratio = 64
w 76 0D 13 # TX bus keeper, Hi-Z, offset 1, TX on Falling edge
w 76 0E 4E # TDM TX voltage sense transmit enable with slot 14,
w 76 0F 4C # TDM TX current sense transmit enable with slot 12
w 76 03 14 # 21 dB gain
w 76 02 00 # power up audio playback with I,V enabled

```

### 10.3 Initial Device Configuration - 44.1 kHz

The following I<sup>2</sup>C sequence is an example of initializing a TAS2764 device into 44.1 kHz sampling rate. This sequence contains a 1 ms delay required after a software or hardware reset as illustrated in [Section 11](#).

```
##### Configure Channel 1
w 70 60 21 # sbclk to fs ratio = 256 / 8 TDM Slots
w 70 08 39 # 44.1KHz, Auto TDM off, Frame start High to Low
w 70 09 03 # Offset = 1, Sync on BCLK falling edge
w 70 0a 0a # TDM slot by address, Word = 24 bit, Frame = 32 bit
w 70 0c 20 # Right Ch = TDM slot 2, Left Ch = TDM slot 0
w 70 0d 33 # TX bus keeper, Hi-Z, offset 1, TX on Falling edge
w 70 0e 42 # TDM TX voltage sense transmit enable with slot 2,
w 70 0f 40 # TDM TX current sense transmit enable with slot 0
w 70 03 14 # 21 dB gain
w 70 02 00 # power up audio playback with I,V enabled
```

### 10.4 Sample Rate Change - 48 kHz to 44.1kHz

The following I<sup>2</sup>C sequence is an example of changing the sampling rate from 48 kHz to 44.1 kHz .

```
w 70 07 28 #Set DVC Ramp Rate to 0.5 dB / 8 samples
w 70 02 01 #Mute
d 1
w 70 02 02 #Software shutdown
w 70 08 39 #44.1KHz, Auto TDM off, Frame start High to Low
### change source sample rate now
w 70 02 01 #Take device out of low-power shutdown
d 1
w 70 02 00 #Un-mute
```

### 10.5 Idle Channel Hysteresis

Recommended to set hysteresis to 1s to ensure gain release operation gets maximum time.

```
w 70 00 00 #Page 0x00
w 70 67 03 #IC hysteresis at 1s
```

### 10.6 DSP Loopback

The following I<sup>2</sup>C sequence will enable the DSP loopback for echo reference.

```
#####DSP Echo Reference Loopback
w 70 00 00 #Page -0
w 70 7F 00
w 70 16 C0 #Audio TX slot programmed to 0
w 70 0E 00 #Disable Vsense
w 70 0E 00 #Disable Vsense
```

## 11 Power Supply and I<sup>2</sup>C Recommendations

During power up and power down PVDD voltage must be greater than (VBAT1S-0.7V)

Once all supplies are stable the SDZ pin can be set high to initialize the part. After a hardware or software reset additional commands to the device should be delayed for at least 1 mS to allow the OTP memory to load.

If the TDM clocks are sent to TAS2764 after the part is programmed through I<sup>2</sup>C to go to Active Mode the TDM clock interrupts will be triggered.

When VBAT1S is internally generated (see below [Section 11.1](#)) it is recommended that the device enters Software Shutdown mode before entering Hardware Shutdown mode. This ensures that VBAT1S pin is discharged using the internal 5 kOhms pull down resistor (not present in HW shutdown mode).

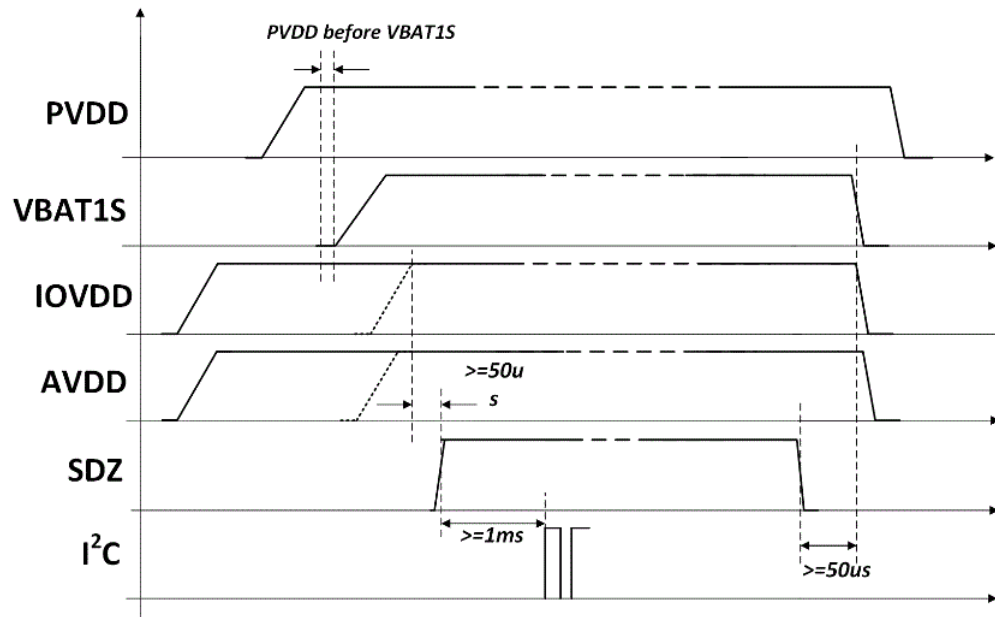


Figure 11-1. Power Supply Sequence for Power-Up and Power-Down

### 11.1 Power Supply Modes

The TAS2764 can operate with both VBAT1S and PVDD as supplies or with only PVDD as supply. The table below shows different power supply modes of operation depending on the customer need.

Table 11-1. Device Configuration and Power Supply Modes

Supply Power Mode	Output Switching Mode	Supply Condition	Device Configurations	Use Case and Device Functionality
PWR_MODE1	Y Bridge High Power on VBAT1S	PVDD > VBAT1S	VBAT1S_MODE=0 BOP_SRC=0 CDS_MODE[1:0]=00	VBAT1S is used to deliver output power based on level and headroom configured. When audio signal crosses a programmed threshold Class-D output is switched over PVDD. BOP source is VBAT1S. PVDD UVLO is disabled. SAR conversion done for VBAT1S, PVDD and temperature.

**Table 11-1. Device Configuration and Power Supply Modes (continued)**

Supply Power Mode	Output Switching Mode	Supply Condition	Device Configurations	Use Case and Device Functionality
PWR_MODE2	Y Bridge Low Power on VBAT1S	PVDD>VBAT1S+2.5V	VBAT1S_MODE=1 BOP_SRC=1 CDS_MODE[1:0]=11	PVDD is the only supply. VBAT1S is delivered by an <b>internal LDO</b> and used to supply at signals close to idle channel levels. When audio signal levels crosses -100dBFS (default), Class_D output switches to PVDD. BOP source is PVDD. PVDD UVLO is enabled. SAR conversion done for PVDD and temperature.
PWR_MODE3	Y Bridge High Power on VBAT1S	PVDD>VBAT1S	VBAT1S_MODE=0 BOP_SRC=1 CDS_MODE[1:0]=00	VBAT1S is used to deliver output power based on level and headroom configured. When audio signal crosses a programmed threshold Class-D output is switched over PVDD. BOP source is PVDD. PVDD UVLO is enabled. SAR conversion done for PVDD and temperature.
PWR_MODE4	PVDD	PVDD>VBAT1S+2.5V	VBAT1S_MODE=1 BOP_SRC=1 CDS_MODE[1:0]=10	Class-D power supplied by PVDD branch of Y bridge. VBAT1S is delivered by an <b>internal LDO</b> . BOP source is PVDD. PVDD UVLO is enabled. SAR conversion done for PVDD and temperature.

For **PWR\_MODE2** and **PWR\_MODE4**, by default, the internal ADC samples only the PVDD pin in order to meet the stringent requirement on brownout latency. If the monitoring of VBAT1S pin is needed the register bit *CONV\_VBAT\_PVDD\_MODE* should be set to high. The additional monitoring of VBAT1S will come at the cost of losing brownout latency.

If VBAT1S is generated by **internal LDO**, customer needs to ensure that PVDD supply level is at least 2.5V above the VBAT1S voltage generated internally. To enable voltage protection the UVLO of PVDD supply should be set above 7.3V by using register bits *PVDD\_UVLO[5:0]*. This will ensure that, with an internally generated VBAT1S of 4.8V, PVDD supply is at least 2.5V higher than VBAT1S.

## 12 Layout

### 12.1 Layout Guidelines

All supply rails should be bypassed by low-ESR ceramic capacitors as shown in [Figure 9-1](#) and described in [Table 9-1](#).

Place the decoupling capacitors as close as possible to the respective power supply pins. Do not place vias between the decoupling capacitors and the device pin. Connect the vias to the ground or power planes on the far side of the capacitor.

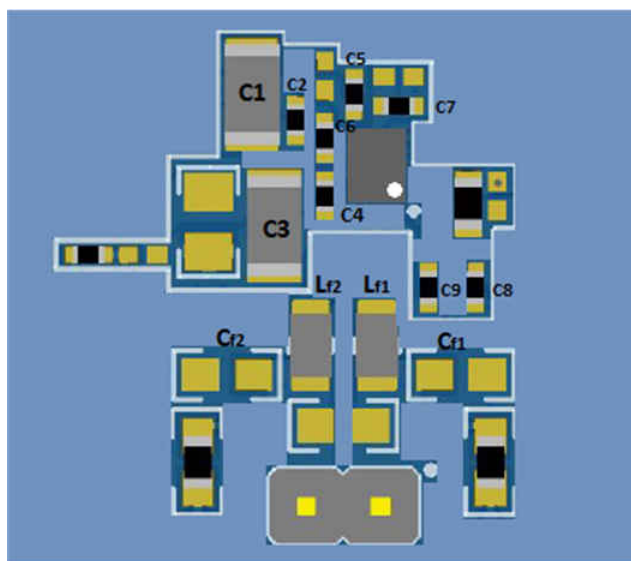
Ground plane in the adjacent layer is recommended. It is required to maintain a single solid ground plane underneath the IC and its decoupling caps. Solid ground plane is the best option, providing continuous (uninterrupted) and low-impedance path for return currents back to the source. Fill the device side layer of the system board with ground copper and connect it to main ground plane using lots of vias. Each ground pin (GND, PGND) should directly shorted to the ground plane in the same layer as device as well as to the main solid ground plane in the adjacent layer through vias.

Specific layout design recommendations should be followed for this device:

- Do not use vias for traces that carry high current: PVDD, VBAT1S, PGND, GND and the speaker OUT\_P, OUT\_N.
- Connect VSNS\_P and VSNS\_N as close as possible to the speaker.
- VSNS\_P and VSNS\_N should be connected between the EMI ferrite filter and the speaker if EMI ferrites are used at the outputs.
- VSNS\_P and VSNS\_N routing should be separated and shielded from switching signals (interface signals, speaker outputs, bootstrap pins).
- Place bootstrap capacitors as close as possible to the BST pins.

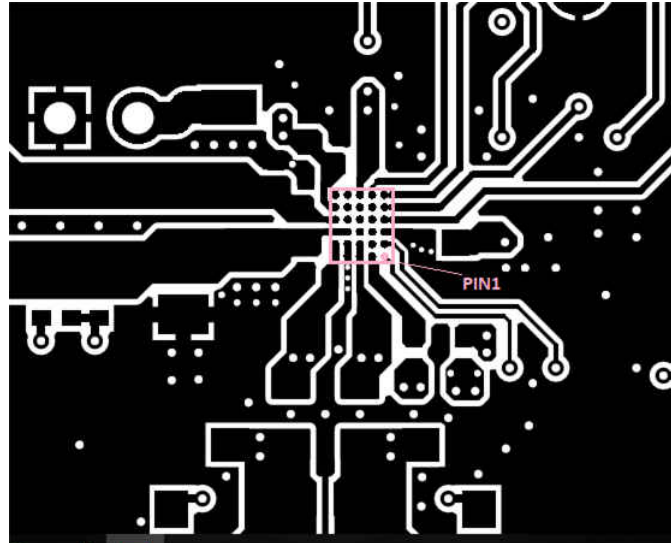
### 12.2 Layout Example

The figure below describes the placement of critical components as presented in [Figure 9-1](#).



**Figure 12-1. Component Placement**

For the component placement from [Figure 12-1](#) an example of layout of top layer is presented below.



**Figure 12-2. Layout Design - Top Copper Layer**

## 13 Device and Documentation Support

### 13.1 Receiving Notification of Documentation Updates

To receive notification of documentation updates, navigate to the device product folder on [ti.com](http://ti.com). Click on *Subscribe to updates* to register and receive a weekly digest of any product information that has changed. For change details, review the revision history included in any revised document.

### 13.2 Support Resources

TI E2E™ [support forums](#) are an engineer's go-to source for fast, verified answers and design help — straight from the experts. Search existing answers or ask your own question to get the quick design help you need.

Linked content is provided "AS IS" by the respective contributors. They do not constitute TI specifications and do not necessarily reflect TI's views; see TI's [Terms of Use](#).

### 13.3 Trademarks

TI E2E™ is a trademark of Texas Instruments.

All trademarks are the property of their respective owners.

### 13.4 Electrostatic Discharge Caution



This integrated circuit can be damaged by ESD. Texas Instruments recommends that all integrated circuits be handled with appropriate precautions. Failure to observe proper handling and installation procedures can cause damage.

ESD damage can range from subtle performance degradation to complete device failure. Precision integrated circuits may be more susceptible to damage because very small parametric changes could cause the device not to meet its published specifications.

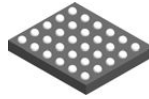
### 13.5 Glossary

[TI Glossary](#) This glossary lists and explains terms, acronyms, and definitions.



## 14 Mechanical, Packaging, and Orderable Information

The following pages include mechanical, packaging, and orderable information. This information is the most current data available for the designated devices. This data is subject to change without notice and revision of this document. For browser-based versions of this data sheet, refer to the left-hand navigation.

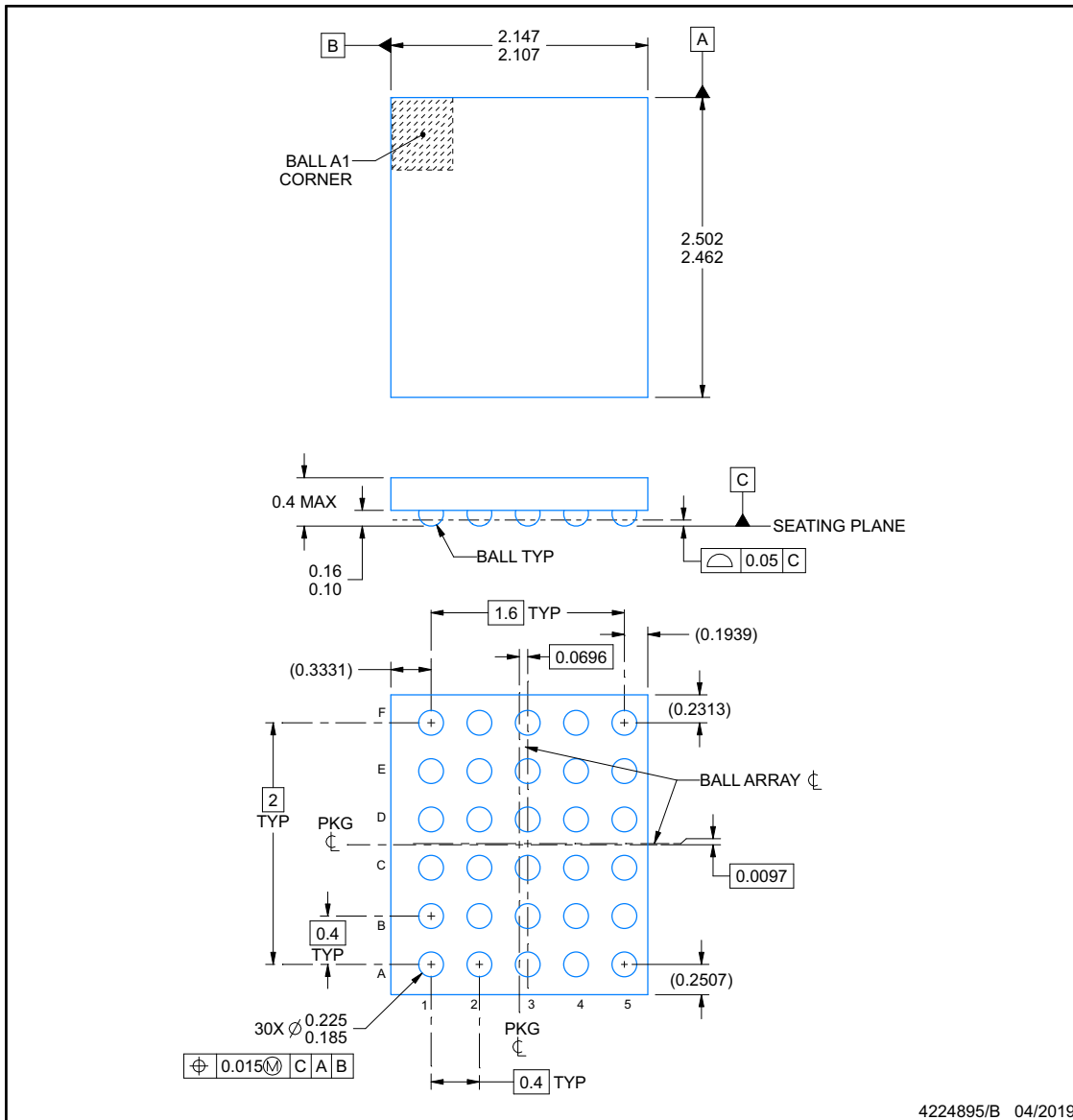


# YBH0030-C01

## PACKAGE OUTLINE

DSBGA - 0.4 mm max height

DIE SIZE BALL GRID ARRAY



**NOTES:**

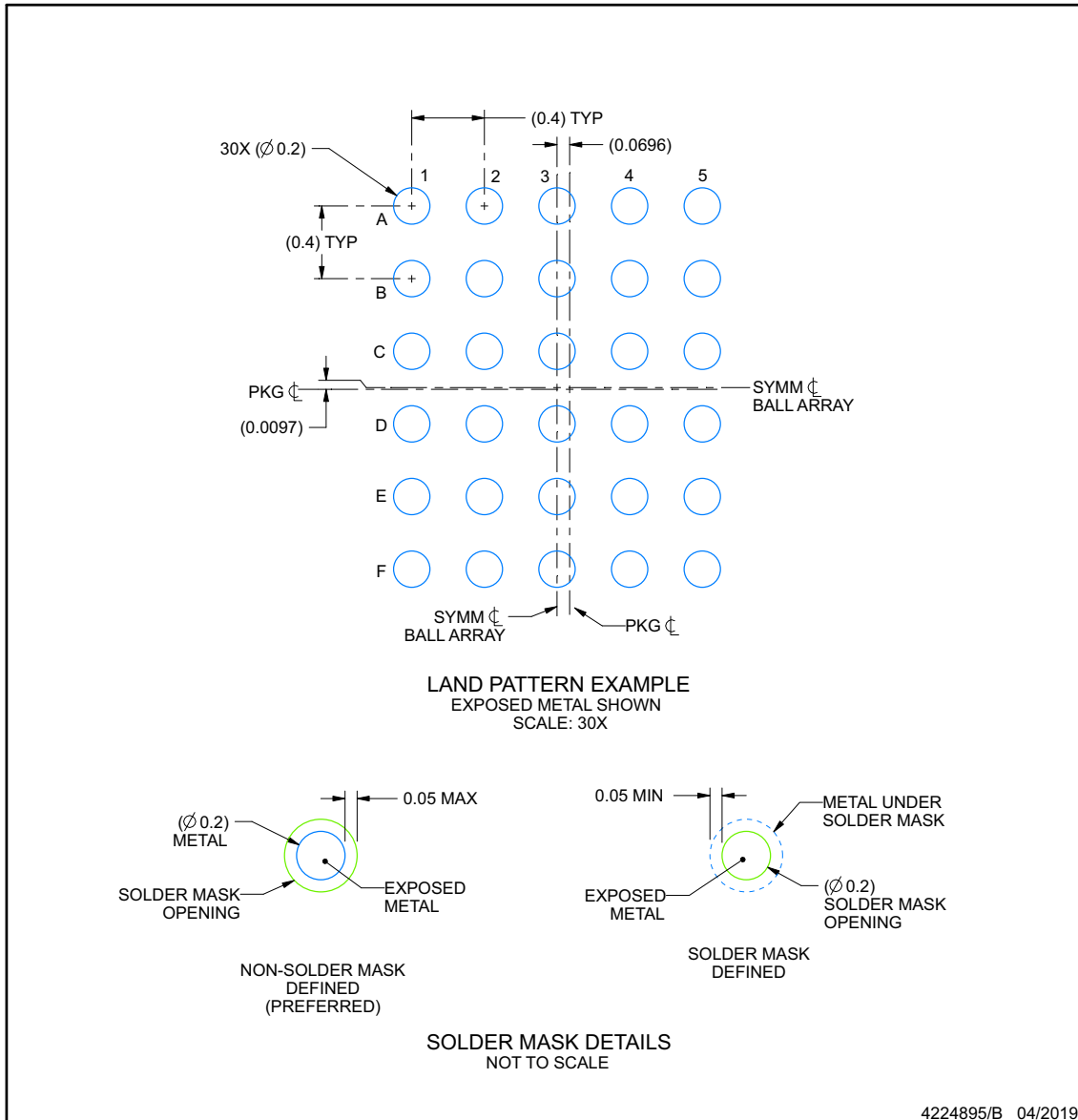
1. All linear dimensions are in millimeters. Any dimensions in parenthesis are for reference only. Dimensioning and tolerancing per ASME Y14.5M.
2. This drawing is subject to change without notice.

## EXAMPLE BOARD LAYOUT

**YBH0030-C01**

**DSBGA - 0.4 mm max height**

DIE SIZE BALL GRID ARRAY



NOTES: (continued)

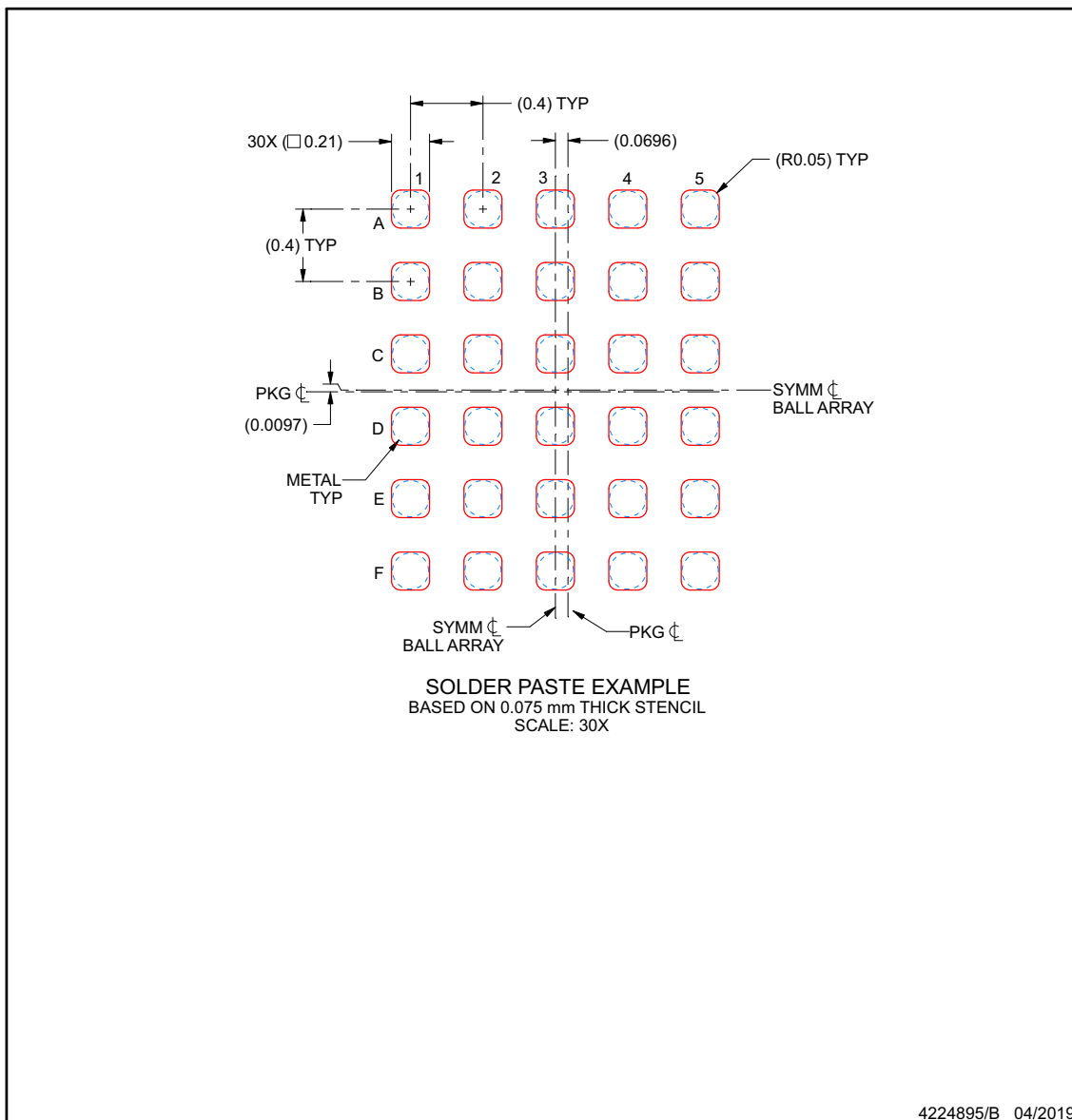
- Final dimensions may vary due to manufacturing tolerance considerations and also routing constraints. See Texas Instruments Literature No. SNVA009 ([www.ti.com/lit/snva009](http://www.ti.com/lit/snva009)).

## EXAMPLE STENCIL DESIGN

**YBH0030-C01**

**DSBGA - 0.4 mm max height**

DIE SIZE BALL GRID ARRAY



NOTES: (continued)

4. Laser cutting apertures with trapezoidal walls and rounded corners may offer better paste release.

**PACKAGING INFORMATION**

Orderable Device	Status (1)	Package Type	Package Drawing	Pins	Package Qty	Eco Plan (2)	Lead finish/ Ball material (6)	MSL Peak Temp (3)	Op Temp (°C)	Device Marking (4/5)	Samples
TAS2764YBHR	ACTIVE	DSBGA	YBH	30	3000	RoHS & Green	SNAGCU	Level-1-260C-UNLIM	-40 to 85	TAS2764	Samples

(1) The marketing status values are defined as follows:

**ACTIVE:** Product device recommended for new designs.

**LIFEBUY:** TI has announced that the device will be discontinued, and a lifetime-buy period is in effect.

**NRND:** Not recommended for new designs. Device is in production to support existing customers, but TI does not recommend using this part in a new design.

**PREVIEW:** Device has been announced but is not in production. Samples may or may not be available.

**OBSELETE:** TI has discontinued the production of the device.

(2) **RoHS:** TI defines "RoHS" to mean semiconductor products that are compliant with the current EU RoHS requirements for all 10 RoHS substances, including the requirement that RoHS substance do not exceed 0.1% by weight in homogeneous materials. Where designed to be soldered at high temperatures, "RoHS" products are suitable for use in specified lead-free processes. TI may reference these types of products as "Pb-Free".

**RoHS Exempt:** TI defines "RoHS Exempt" to mean products that contain lead but are compliant with EU RoHS pursuant to a specific EU RoHS exemption.

**Green:** TI defines "Green" to mean the content of Chlorine (Cl) and Bromine (Br) based flame retardants meet JS709B low halogen requirements of <=1000ppm threshold. Antimony trioxide based flame retardants must also meet the <=1000ppm threshold requirement.

(3) MSL, Peak Temp. - The Moisture Sensitivity Level rating according to the JEDEC industry standard classifications, and peak solder temperature.

(4) There may be additional marking, which relates to the logo, the lot trace code information, or the environmental category on the device.

(5) Multiple Device Markings will be inside parentheses. Only one Device Marking contained in parentheses and separated by a "~" will appear on a device. If a line is indented then it is a continuation of the previous line and the two combined represent the entire Device Marking for that device.

(6) Lead finish/Ball material - Orderable Devices may have multiple material finish options. Finish options are separated by a vertical ruled line. Lead finish/Ball material values may wrap to two lines if the finish value exceeds the maximum column width.

**Important Information and Disclaimer:**The information provided on this page represents TI's knowledge and belief as of the date that it is provided. TI bases its knowledge and belief on information provided by third parties, and makes no representation or warranty as to the accuracy of such information. Efforts are underway to better integrate information from third parties. TI has taken and continues to take reasonable steps to provide representative and accurate information but may not have conducted destructive testing or chemical analysis on incoming materials and chemicals. TI and TI suppliers consider certain information to be proprietary, and thus CAS numbers and other limited information may not be available for release.

In no event shall TI's liability arising out of such information exceed the total purchase price of the TI part(s) at issue in this document sold by TI to Customer on an annual basis.

**TAPE AND REEL INFORMATION**

**QUADRANT ASSIGNMENTS FOR PIN 1 ORIENTATION IN TAPE**


\*All dimensions are nominal

Device	Package Type	Package Drawing	Pins	SPQ	Reel Diameter (mm)	Reel Width W1 (mm)	A0 (mm)	B0 (mm)	K0 (mm)	P1 (mm)	W (mm)	Pin1 Quadrant
TAS2764YBHR	DSBGA	YBH	30	3000	180.0	8.4	2.27	2.68	0.52	4.0	8.0	Q1

**TAPE AND REEL BOX DIMENSIONS**


\*All dimensions are nominal

Device	Package Type	Package Drawing	Pins	SPQ	Length (mm)	Width (mm)	Height (mm)
TAS2764YBHR	DSBGA	YBH	30	3000	182.0	182.0	20.0

## IMPORTANT NOTICE AND DISCLAIMER

TI PROVIDES TECHNICAL AND RELIABILITY DATA (INCLUDING DATA SHEETS), DESIGN RESOURCES (INCLUDING REFERENCE DESIGNS), APPLICATION OR OTHER DESIGN ADVICE, WEB TOOLS, SAFETY INFORMATION, AND OTHER RESOURCES "AS IS" AND WITH ALL FAULTS, AND DISCLAIMS ALL WARRANTIES, EXPRESS AND IMPLIED, INCLUDING WITHOUT LIMITATION ANY IMPLIED WARRANTIES OF MERCHANTABILITY, FITNESS FOR A PARTICULAR PURPOSE OR NON-INFRINGEMENT OF THIRD PARTY INTELLECTUAL PROPERTY RIGHTS.

These resources are intended for skilled developers designing with TI products. You are solely responsible for (1) selecting the appropriate TI products for your application, (2) designing, validating and testing your application, and (3) ensuring your application meets applicable standards, and any other safety, security, regulatory or other requirements.

These resources are subject to change without notice. TI grants you permission to use these resources only for development of an application that uses the TI products described in the resource. Other reproduction and display of these resources is prohibited. No license is granted to any other TI intellectual property right or to any third party intellectual property right. TI disclaims responsibility for, and you will fully indemnify TI and its representatives against, any claims, damages, costs, losses, and liabilities arising out of your use of these resources.

TI's products are provided subject to [TI's Terms of Sale](#) or other applicable terms available either on [ti.com](https://www.ti.com) or provided in conjunction with such TI products. TI's provision of these resources does not expand or otherwise alter TI's applicable warranties or warranty disclaimers for TI products.

TI objects to and rejects any additional or different terms you may have proposed.

Mailing Address: Texas Instruments, Post Office Box 655303, Dallas, Texas 75265  
Copyright © 2023, Texas Instruments Incorporated