

5.0A SURFACE MOUNT SCHOTTKY BARRIER DIODE

Features

- Schottky Barrier Chip
- Ideally Suited for Automatic Assembly
- Low Power Loss, High Efficiency
- Surge Overload Rating to 175A Peak
- For Use in Low Voltage Application
- Guard Ring Die Construction
- Plastic Case Material has UL Flammability Classification Rating 94V-O

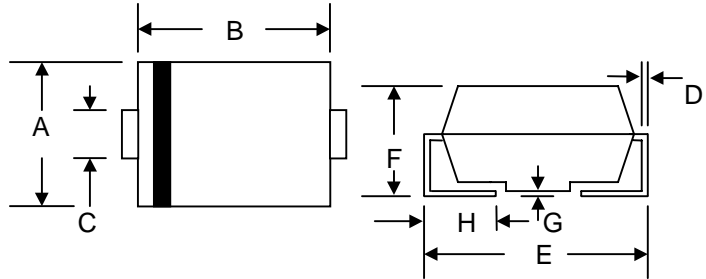

Mechanical Data

- Case: SMC/DO-214AB, Molded Plastic
- Terminals: Solder Plated, Solderable per MIL-STD-750, Method 2026
- Polarity: Cathode Band or Cathode Notch
- Marking: Type Number
- Weight: 0.21 grams (approx.)
- **Lead Free: For RoHS / Lead Free Version, Add "-LF" Suffix to Part Number, See Page 4**

SMC/DO-214AB		
Dim	Min	Max
A	5.59	6.22
B	6.60	7.11
C	2.75	3.25
D	0.152	0.305
E	7.75	8.13
F	2.00	2.62
G	0.051	0.203
H	0.76	1.27
All Dimensions in mm		

Maximum Ratings and Electrical Characteristics @ $T_A=25^\circ\text{C}$ unless otherwise specified

Characteristic	Symbol	SK52	SK53	SK54	SK55	SK56	SK58	SK59	S510	Unit	
Peak Repetitive Reverse Voltage	V_{RRM}										
Working Peak Reverse Voltage	V_{RWM}	20	30	40	50	60	80	90	100	V	
DC Blocking Voltage	V_R										
RMS Reverse Voltage	$V_{R(RMS)}$	14	21	28	35	42	56	64	71	V	
Average Rectified Output Current @ $T_L = 90^\circ\text{C}$	I_O	5.0								A	
Non-Repetitive Peak Forward Surge Current 8.3ms Single half sine-wave superimposed on rated load (JEDEC Method)	I_{FSM}	175								A	
Forward Voltage @ $I_F = 5.0\text{A}$	V_{FM}	0.50		0.75		0.85				V	
Peak Reverse Current @ $T_A = 25^\circ\text{C}$ At Rated DC Blocking Voltage @ $T_A = 100^\circ\text{C}$	I_{RM}	0.5					20				mA
Typical Thermal Resistance (Note 1)	$R_{\theta JL}$ $R_{\theta JA}$	14					50				$^\circ\text{C/W}$
Operating Temperature Range	T_j	-65 to +125								$^\circ\text{C}$	
Storage Temperature Range	T_{STG}	-65 to +150								$^\circ\text{C}$	

Note: 1. Mounted on P.C. Board with 14mm² copper pad area.

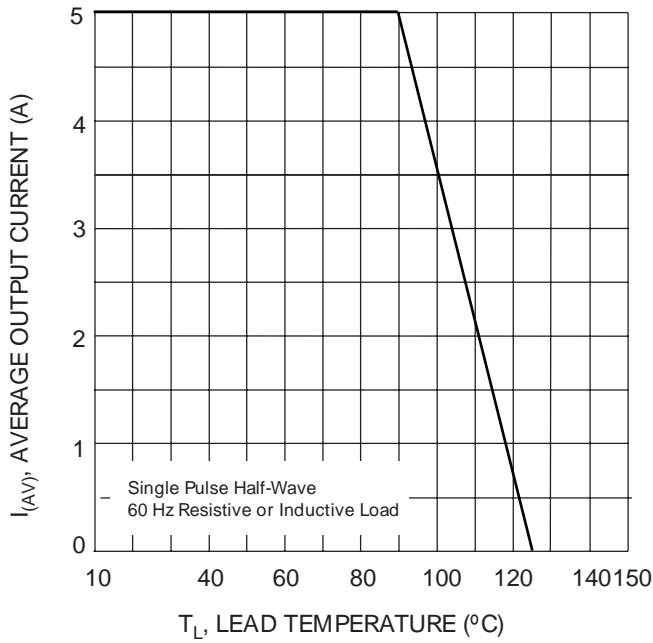

Fig. 1 Forward Current Derating Curve

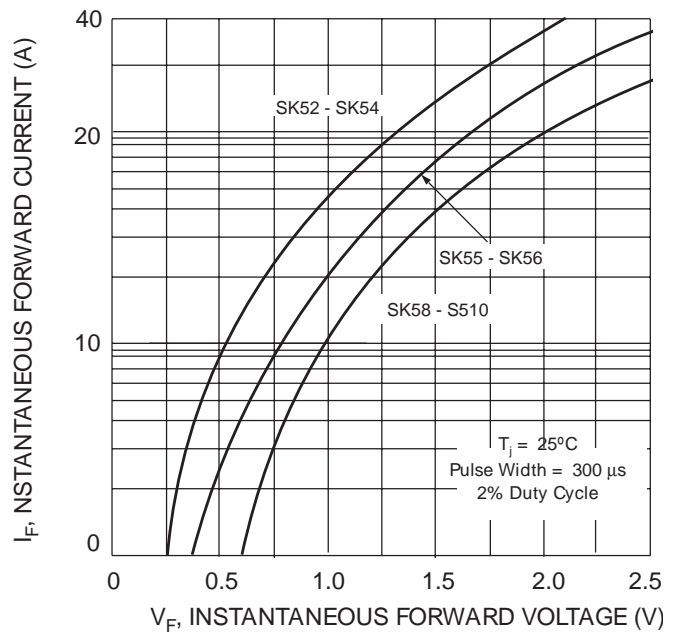

Fig. 2 Typical Forward Characteristics

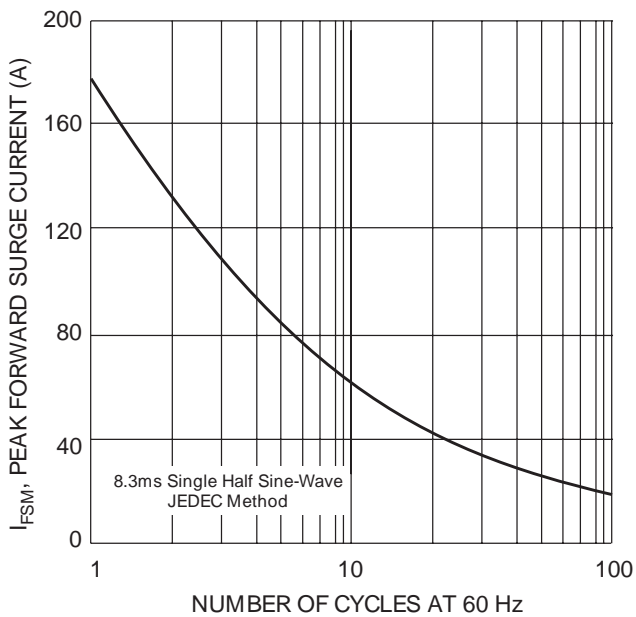

Fig. 3 Maximum Non-Repetitive Peak Fwd Surge Current

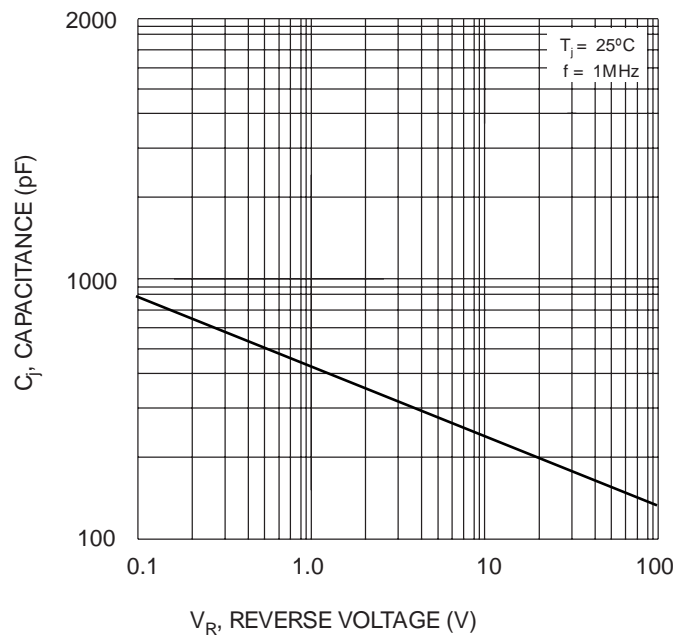



Fig. 4 Typical Junction Capacitance

MARKING INFORMATION

RECOMMENDED FOOTPRINT

www.DataSheet4U.com



Cathode = Polarity Band
WTE = Manufacturer's Logo
SK5x = Device Number Except S510
x = 2, 3, 4, 5, 6, 8 or 9

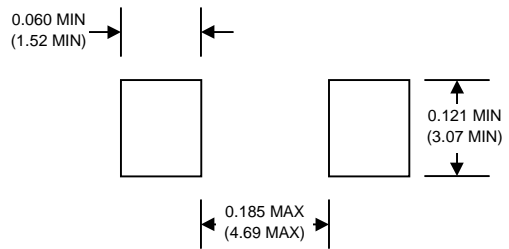

inches(mm)

PACKAGING INFORMATION

TAPE & REEL

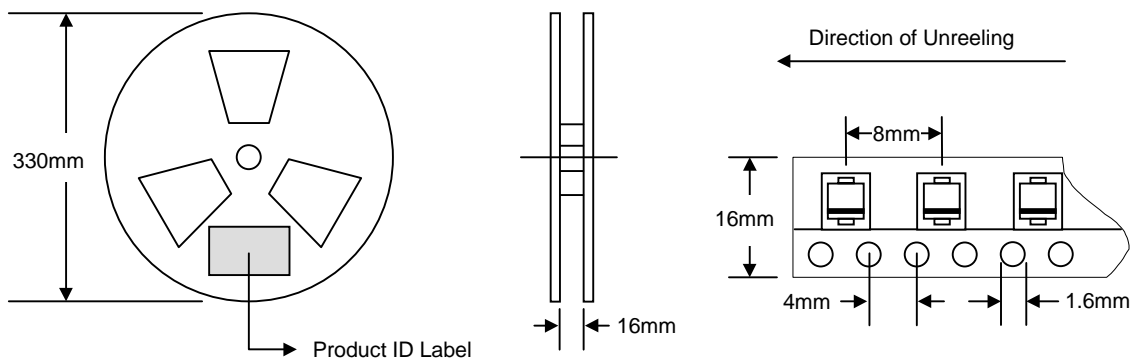

Reel Diameter (mm)	Quantity (PCS)	Inner Box Size L x W x H (mm)	Quantity (PCS)	Carton Size L x W x H (mm)	Quantity (PCS)	Approx. Gross Weight (KG)
330	3,000	340 x 337 x 45	6,000	370 x 370 x 420	48,000	19.0

Note: 1. Paper reel, white or gray color.
2. Components are packed in accordance with EIA standard 481-1 and 481-2.

ORDERING INFORMATION

Product No.	Package Type	Shipping Quantity
SK52-T3	SMC	3000/Tape & Reel
SK53-T3	SMC	3000/Tape & Reel
SK54-T3	SMC	3000/Tape & Reel
SK55-T3	SMC	3000/Tape & Reel
SK56-T3	SMC	3000/Tape & Reel
SK58-T3	SMC	3000/Tape & Reel
SK59-T3	SMC	3000/Tape & Reel
S510-T3	SMC	3000/Tape & Reel

- Shipping quantity given is for minimum packing quantity only. For minimum order quantity, please consult the Sales Department.
- To order RoHS / Lead Free version (with Lead Free finish), add "-LF" suffix to part number above. For example, SK52-T3-LF.**

Won-Top Electronics Co., Ltd (WTE) has checked all information carefully and believes it to be correct and accurate. However, WTE cannot assume any responsibility for inaccuracies. Furthermore, this information does not give the purchaser of semiconductor devices any license under patent rights to manufacturer. WTE reserves the right to change any or all information herein without further notice.

WARNING: DO NOT USE IN LIFE SUPPORT EQUIPMENT. WTE power semiconductor products are not authorized for use as critical components in life support devices or systems without the express written approval.

Won-Top Electronics Co., Ltd.

No. 44 Yu Kang North 3rd Road, Chine Chen Dist., Kaohsiung, Taiwan

Phone: 886-7-822-5408 or 886-7-822-5410**Fax:** 886-7-822-5417**Email:** sales@wontop.com**Internet:** http://www.wontop.com*We power your everyday.*