



DC COMPONENTS CO., LTD.

RECTIFIER SPECIALISTS

**SM320
THRU
SM360**

TECHNICAL SPECIFICATIONS OF SURFACE MOUNT SCHOTTKY BARRIER RECTIFIER

VOLTAGE RANGE - 20 to 60 Volts

CURRENT - 3.0 Amperes

FEATURES

- * High current capability
- * Ideal for surface mounted applications
- * Low leakage current for high efficiency

MECHANICAL DATA

- * Case: Molded plastic
- * Epoxy: UL 94V-0 rate flame retardant
- * Terminals: Solder plated solderable per MIL-STD-202E, Method 208 guaranteed
- * Polarity: Color band denotes cathode end
- * Mounting position: Any
- * Weight: 0.12 gram

MAXIMUM RATINGS AND ELECTRICAL CHARACTERISTICS

Ratings at 25 °C ambient temperature unless otherwise specified.
Single phase, half wave, 60 Hz, resistive or inductive load.
For capacitive load, derate current by 20%.



SM-1(DO-213AB)

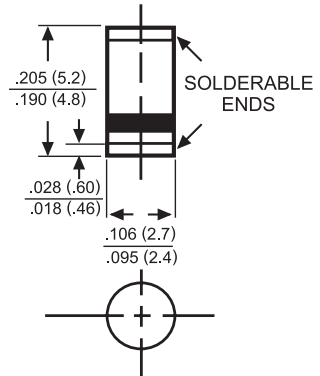

Dimensions in inches and (millimeters)

	SYMBOL	SM320	SM330	SM340	SM350	SM360	UNITS
Maximum Recurrent Peak Reverse Voltage	V _{RRM}	20	30	40	50	60	Volts
Maximum RMS Voltage	V _{RMS}	14	21	28	35	42	Volts
Maximum DC Blocking Voltage	V _{DC}	20	30	40	50	60	Volts
Maximum Average Forward Rectified Current at T _A =90°C	I _O	3.0					Amps
Peak Forward Surge Current 8.3 ms single half sine-wave superimposed on rated load (JEDEC Method)	I _{FSM}	80					Amps
Maximum Instantaneous Forward Voltage at 3.0A DC	V _F	.475	.500	.525	.70		
Maximum DC Reverse Current at @ T _A = 25°C	I _R	1.0					mAmps
Rated DC Blocking Voltage @ T _A = 100°C		25					
Typical Thermal Resistance (Note1)	R _{θJA}	40					°C/W
Typical Junction Capacitance (Note 2)	C _J	200					pF
Storage Operating Temperature Range	T _J , T _{STG}	-65 to + 125					°C

NOTES : 1. Thermal Resistance (Junction to Ambient), .24in² (6.0mm²) copper pads to each terminal.
2. Measured at 1 MHz and applied reverse voltage of 4.0 volts.

RATING AND CHARACTERISTIC CURVES (SM320 THRU SM360)

FIG. 1 - TYPICAL FORWARD CURRENT DERATING CURVE

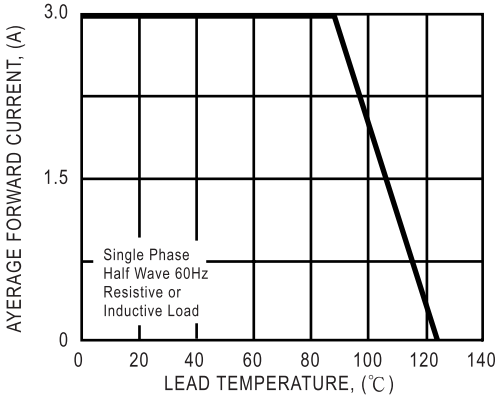

FIG. 2 - TYPICAL INSTANTANEOUS FORWARD CHARACTERISTICS

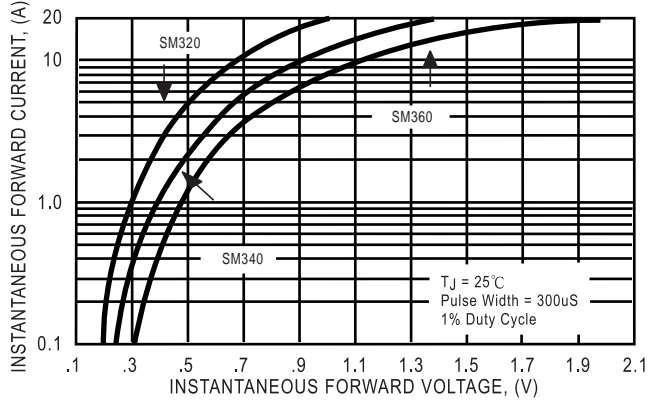

FIG. 3 - TYPICAL REVERSE CHARACTERISTICS

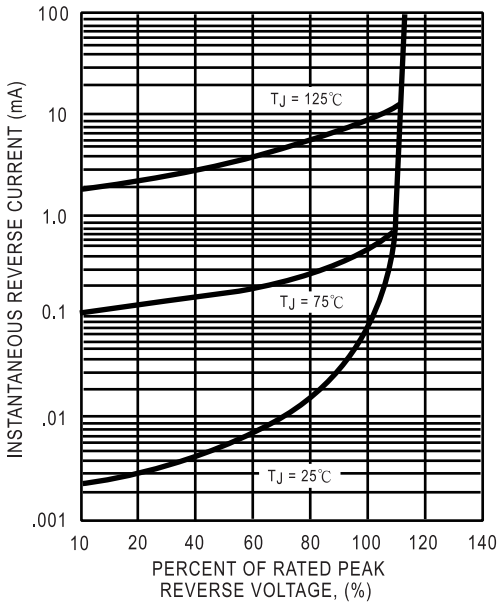

FIG. 4 - MAXIMUM NON-REPETITIVE FORWARD SURGE CURRENT

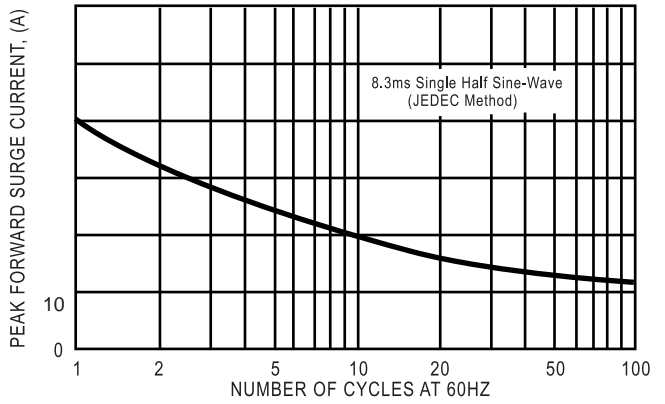
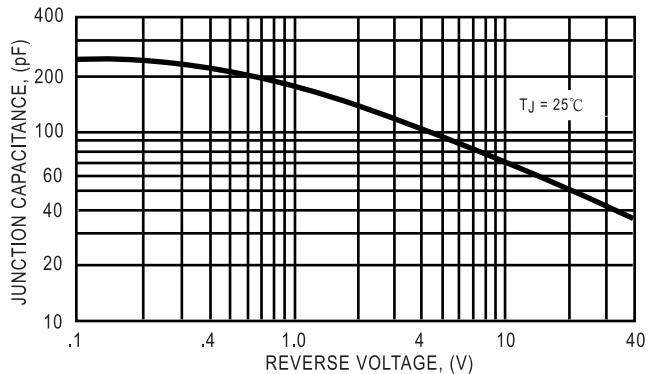

FIG. 5 - TYPICAL JUNCTION CAPACITANCE



DC COMPONENTS CO., LTD.