

<Intelligent Power Modules>

PM200RG1C120

FLAT-BASE TYPE
INSULATED PACKAGE

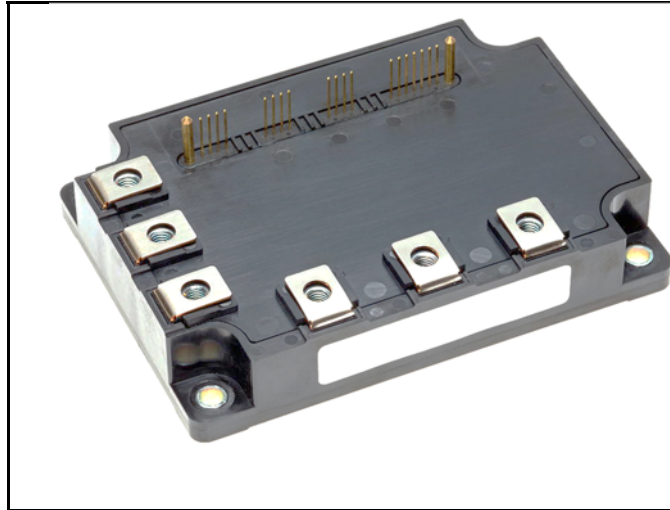

FEATURE

- Adopting Full-Gate CSTBT™ chip.
- The over-temperature protection which detects the chip surface temperature of CSTBT™ is adopted.
- Error output signal is available from each protection upper and lower arm of IPM.
- Outputting an error signal corresponding to the abnormal state (error mode identification)

UL Recognized under UL1557, File No. E323585

This product is compliant with the Restriction of the Use of Certain Hazardous Substances in Electrical and Electronic Equipment (RoHS) directive 2011/65/EU.

APPLICATION

General purpose inverter, servo drives and other motor controls

PACKAGE OUTLINES

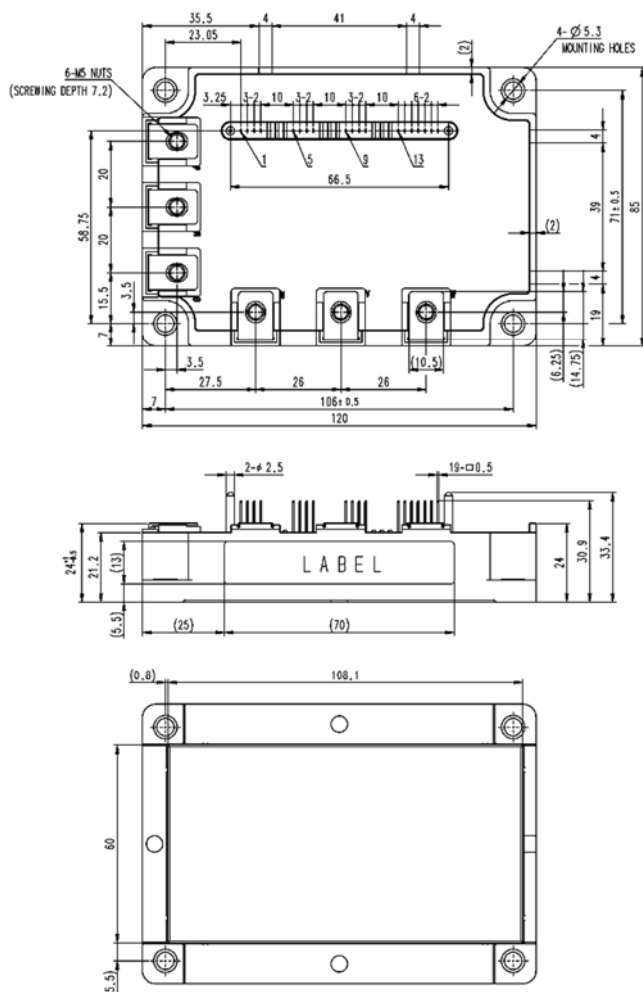

Dimensions in mm

Tolerance otherwise specified

| Division of Dimension | | Tolerance |
|-----------------------|--------|-----------|
| 0.5 | to 3 | ±0.2 |
| over 3 | to 6 | ±0.3 |
| over 6 | to 30 | ±0.5 |
| over 30 | to 120 | ±0.8 |
| over 120 | to 400 | ±1.2 |

TERMINAL CODE

- V_{UPC}
- U_{FO}
- U_P
- V_{UP1}
- V_{VPC}
- V_{FO}
- V_P
- V_{VP1}
- V_{WPC}
- W_{FO}
- W_P
- V_{WP1}
- V_{NC}
- V_{N1}
- BR
- U_N
- V_N
- W_N
- F_O

PM200RG1C120

HIGH POWER SWITCHING USE
INSULATED TYPE

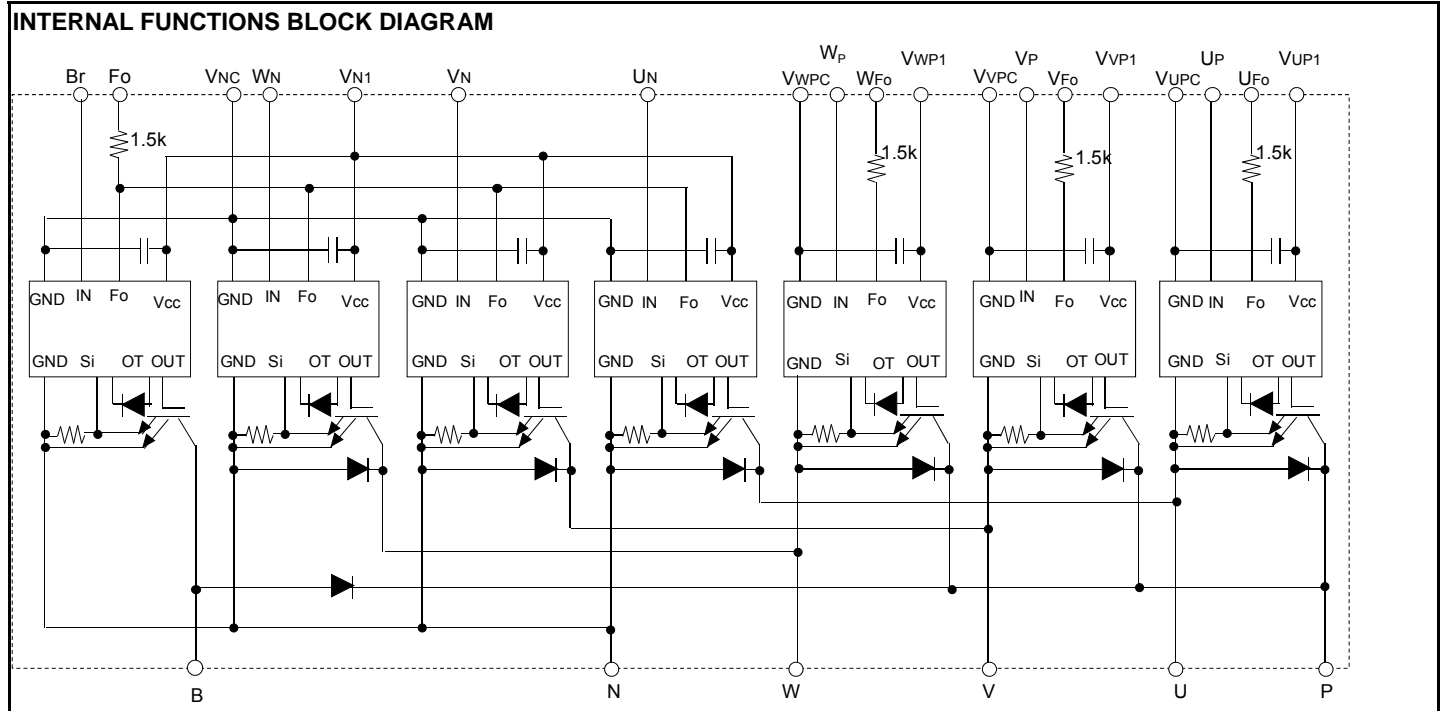

MAXIMUM RATINGS (Tvj = 25°C, unless otherwise noted)

INVERTER PART

| Symbol | Parameter | Conditions | Ratings | Unit |
|-----------|---------------------------------------|--|------------|------|
| V_{CES} | Collector-Emitter Voltage | $V_D=15\text{ V}, V_{CIN}=15\text{ V}$ | 1200 | V |
| I_C | Collector Current | $T_C=25\text{ }^\circ\text{C}$ | 200 | A |
| I_{CRM} | | Pulse | 400 | |
| P_{tot} | Total Power Dissipation | $T_C=25\text{ }^\circ\text{C}$ | 1250 | W |
| I_E | Emitter Current | $T_C=25\text{ }^\circ\text{C}$ | 200 | A |
| I_{ERM} | (Free-wheeling Diode Forward current) | Pulse | 400 | |
| T_{vj} | Junction Temperature | | -20 ~ +150 | °C |

*: Tc measurement point is just under the chip.

BRAKE PART

| Symbol | Parameter | Conditions | Ratings | Unit |
|-------------|--------------------------------|--|------------|------|
| V_{CES} | Collector-Emitter Voltage | $V_D=15\text{ V}, V_{CIN}=15\text{ V}$ | 1200 | V |
| I_C | Collector Current | $T_C=25\text{ }^\circ\text{C}$ | 100 | A |
| I_{CRM} | | Pulse | 200 | |
| P_{tot} | Total Power Dissipation | $T_C=25\text{ }^\circ\text{C}$ | 735 | W |
| $V_{R(DC)}$ | Diode Rated Reverse DC Voltage | $T_C=25\text{ }^\circ\text{C}$ | 1200 | V |
| I_F | Diode Forward Current | $T_C=25\text{ }^\circ\text{C}$ | 100 | A |
| T_j | Junction Temperature | | -20 ~ +150 | °C |

*: Tc measurement point is just under the chip.

CONTROL PART

| Symbol | Parameter | Conditions | Ratings | Unit |
|-----------|-----------------------------|---|---------|------|
| V_D | Supply Voltage | Applied between: $V_{UP1}-V_{UPC}, V_{VP1}-V_{VPC}, V_{WP1}-V_{WPC}, V_{N1}-V_{NC}$ | 20 | V |
| V_{CIN} | Input Voltage | Applied between: $U_P-V_{UPC}, V_P-V_{VPC}, W_P-V_{WPC}, U_N, V_N, W_N, Br -V_{NC}$ | 20 | V |
| V_{FO} | Fault Output Supply Voltage | Applied between: $U_{FO}-V_{UPC}, V_{FO}-V_{VPC}, W_{FO}-V_{WPC}, FO-V_{NC}$ | 20 | V |
| I_{FO} | Fault Output Current | Sink current at $U_{FO}, V_{FO}, W_{FO}, FO$ terminals | 20 | mA |

PM200RG1C120

HIGH POWER SWITCHING USE
INSULATED TYPE

TOTAL SYSTEM

| Symbol | Parameter | Conditions | Ratings | Unit |
|----------------|--------------------------------|---|------------|------------------|
| $V_{CC(Prot)}$ | Supply Voltage Protected by SC | $V_D = 13.5 \text{ V} \sim 16.5 \text{ V}$, Inverter Part, $T_{vj} = +125^\circ\text{C}$ start | 800 | V |
| T_{stg} | Storage Temperature | - | -40 ~ +125 | $^\circ\text{C}$ |
| T_C | Operating Case Temperature | - | -20 ~ +125 | $^\circ\text{C}$ |
| V_{isol} | Isolation Voltage | 60Hz, Sinusoidal, Charged part to Base plate, AC 1min, RMS | 2500 | V |

*: T_C measurement point is just under the chip.

THERMAL RESISTANCE

| Symbol | Parameter | Conditions | Limits | | | Unit |
|----------------|----------------------------|--|--------|------|------|------|
| | | | Min. | Typ. | Max. | |
| $R_{th(j-c)Q}$ | Thermal Resistance | Inverter, Junction to case, IGBT, per 1 element (Note1) | - | - | 0.10 | K/W |
| $R_{th(j-c)D}$ | | Inverter, Junction to case, FWD, per 1 element (Note1) | - | - | 0.15 | |
| $R_{th(j-c)Q}$ | | Brake, Junction to case, IGBT, per 1 element (Note1) | - | - | 0.17 | |
| $R_{th(j-c)D}$ | | Brake, Junction to case, FWD, per 1 element (Note1) | - | - | 0.25 | |
| $R_{th(c-s)}$ | Contact Thermal Resistance | Case to heat sink, per 1 module, Thermal grease applied (Note.1, 2) | - | 8.4 | - | K/kW |

Note1. If you use this value, $R_{th(s-a)}$ should be measured just under the chips.

Note2. Typical value is measured by using thermally conductive grease of $\lambda = 0.9 \text{ W}/(\text{m}\cdot\text{K})$, $D_{(c-s)} = 50 \mu\text{m}$.

CHIP LOCATION (Top view)

Dimension in mm, tolerance: $\pm 1 \text{ mm}$

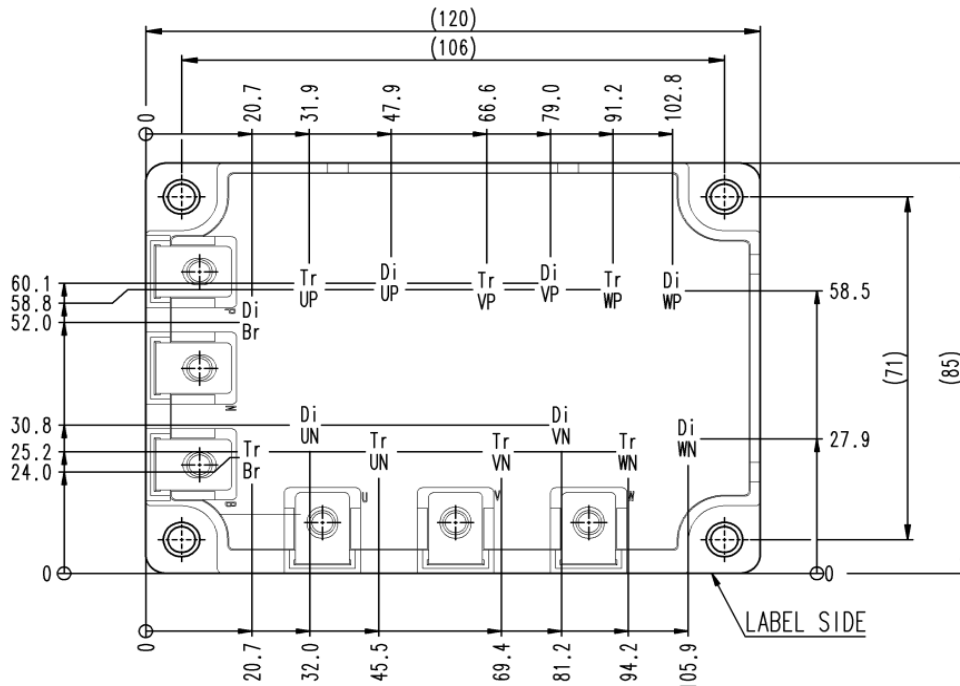

| | |
|-----------|--------|
| Tr^{**} | : IGBT |
| Di^{**} | : FWD |

PM200RG1C120

HIGH POWER SWITCHING USE
INSULATED TYPE

ELECTRICAL CHARACTERISTICS (Tvj= 25°C, unless otherwise noted)

INVERTER PART

| Symbol | Parameter | Conditions | | | Limits | | | Unit |
|---------------------|--------------------------------------|---|------------|------------|--------|------|------|------|
| | | | | | Min. | Typ. | Max. | |
| V _{CEsat} | Collector-Emitter Saturation Voltage | V _D =15 V, I _C =200 A | Tvj=25 °C | Terminal | - | - | 1.95 | V |
| | | | | Chip | - | 1.3 | - | |
| | | V _{CIN} =0 V, Pulsed, (Fig.1) | Tvj=125 °C | Terminal | - | - | 2.2 | |
| | | | | Chip | - | 1.5 | - | |
| V _{EC} | Emitter-Collector Voltage | V _D =15 V, I _E =200 A, | Tvj=25 °C | Terminal | - | - | 2.45 | V |
| | | | | Chip | - | 1.75 | - | |
| | | V _{CIN} = 15 V, pulsed, (Fig.2) | Tvj=125 °C | Terminal | - | - | 2.7 | |
| | | | | Chip | - | 1.95 | - | |
| t _{on} | Switching Time | V _D =15 V, V _{CIN} =0 V↔15 V, V _{CC} =600 V, I _C =200A, Tvj=125 °C, Inductive Load (Fig.3, 4) | | | 0.3 | 0.6 | 1.2 | μs |
| t _{rr} | | | | | - | 0.2 | 0.4 | |
| t _{c(on)} | | | | | - | 0.2 | 0.4 | |
| t _{off} | | | | | - | 1.2 | 2.8 | |
| t _{c(off)} | | | | | - | 0.4 | 1.2 | |
| I _{CES} | Collector-Emitter Cut-off Current | V _{CE} =V _{CES} , V _D =15 V, V _{CIN} =15 V (Fig.5) | | Tvj=25 °C | - | - | 1 | mA |
| | | | | Tvj=125 °C | - | - | 10 | |

BRAKE PART

| Symbol | Parameter | Conditions | | | Limits | | | Unit |
|--------------------|--------------------------------------|--|------------|------------|--------|------|------|------|
| | | | | | Min. | Typ. | Max. | |
| V _{CEsat} | Collector-Emitter Saturation Voltage | V _D =15 V, I _C =100A | Tvj=25 °C | Terminal | - | - | 1.85 | V |
| | | | | Chip | - | 1.3 | - | |
| | | V _{CIN} =0 V, Pulsed, (Fig.1) | Tvj=125 °C | Terminal | - | - | 2.1 | |
| | | | | Chip | - | 1.5 | - | |
| V _{FM} | Diode Forward Voltage | I _F =100A | Tvj=25 °C | Terminal | - | - | 2.4 | V |
| | | | | Chip | - | 1.75 | - | |
| | | | Tvj=125 °C | Terminal | - | - | 2.65 | |
| | | | | Chip | - | 1.95 | - | |
| I _{CES} | Collector-Emitter Cut-off Current | V _{CE} =V _{CES} , V _D =15 V, V _{CIN} =15 V (Fig.5) | | Tvj=25 °C | - | - | 1 | mA |
| | | | | Tvj=125 °C | - | - | 10 | |

PM200RG1C120

HIGH POWER SWITCHING USE
INSULATED TYPE

ELECTRICAL CHARACTERISTICS (Tvj = 25°C, unless otherwise noted)

CONTROL PART

| Symbol | Parameter | Conditions | Limits | | | Unit | |
|----------------------|----------------------------------|--|----------------------------------|------|------|------|----|
| | | | Min. | Typ. | Max. | | |
| I _D | Circuit Current | V _D =15 V, V _{CIN} =15 V | V _{P1} -V _{PC} | - | 4 | 6 | mA |
| | | | V _{N1} -V _{NC} | - | 16 | 24 | |
| | | V _D =15 V, V _{CIN} =0 V ↔ 15 V, V _{CC} =800 V I _C =0A, Tvj=125 °C, f _C ≤20kHz | V _{P1} -V _{PC} | - | 54 | 65 | |
| | | | V _{N1} -V _{NC} | - | 192 | 231 | |
| V _{th(ON)} | Input ON Threshold Voltage | Applied between: | 1.2 | 1.5 | 1.8 | V | |
| V _{th(OFF)} | Input OFF Threshold Voltage | U _P -V _{UPC} , V _P -V _{VPC} , W _P -V _{WPC} , U _N , V _N , W _N , Br-V _{NC} | 1.7 | 2.0 | 2.3 | | |
| SC | Short Circuit Trip Level | -20≤Tvj≤125 °C, V _D =15 V (Fig.3, 6) | Inverter | 400 | - | - | A |
| | | | Brake | 200 | - | - | |
| t _{d(SC)} | Short Circuit Current Delay Time | V _D =15 V, Tvj=125 °C (Fig.3, 6) | - | 2.0 | - | μs | |
| OT | Over Temperature Protection | Detect temperature of IGBT chip surface | Trip level | 150 | - | - | °C |
| | | | Hysteresis | - | 20 | - | |
| UV _t | Supply Circuit | - | Trip level | 11.0 | 12.0 | 12.7 | V |
| UV _r | Under-Voltage Protection | | Reset level | - | 12.5 | - | |
| I _{FO(H)} | Fault Output Current | V _D =15 V, V _{FO} =15 V (Note3) | - | - | 0.01 | mA | |
| I _{FO(L)} | | | - | 10 | 15 | | |
| t _{FO} | Fault Output Pulse Width | V _D =15 V (Note3) | OT | - | 8.0 | - | ms |
| | | | UV | - | 4.0 | - | |
| | | | SC | - | 2.0 | - | |

Note3. Fault output is given only when the internal SC, OT & UV protections schemes of either upper or lower arm device operate to protect it.

MECHANICAL RATINGS AND CHARACTERISTICS

| Symbol | Parameter | Conditions | Limits | | | Unit |
|----------------|-----------------|-------------------------------|--------|------|------|------|
| | | | Min. | Typ. | Max. | |
| M _s | Mounting Torque | Mounting part screw : M5 | 2.5 | 3.0 | 3.5 | N•m |
| M _t | Mounting Torque | Main terminal part screw : M5 | 2.5 | 3.0 | 3.5 | |
| m | mass | - | - | 425 | - | g |

RECOMMENDED CONDITIONS FOR USE

| Symbol | Parameter | Conditions | Recommended value | Unit |
|-----------------------|---------------------------------|---|-------------------|------|
| V _{CC} | Supply Voltage | Applied across P-N terminals | ≤ 800 | V |
| V _D | Control Supply Voltage | Applied between : V _{UP1} -V _{UPC} , V _{VP1} -V _{VPC} , V _{WP1} -V _{WPC} , V _{N1} -V _{NC} (Note4) | 15.0±1.5 | V |
| V _{CIN(ON)} | Input ON Voltage | Applied between : U _P -V _{UPC} , V _P -V _{VPC} , W _P -V _{WPC} , U _N , V _N , W _N , Br-V _{NC} | ≤ 0.8 | V |
| V _{CIN(OFF)} | Input OFF Voltage | | ≥ 9.0 | |
| f _{PWM} | PWM Input Frequency | Using Application Circuit of Fig. 8 | ≤ 20 | kHz |
| t _{dead} | Arm Shoot-through Blocking Time | For IPM's each input signals (Fig.7) | ≥ 2.5 | μs |

This product is compliant with the Restriction of the Use of Certain Hazardous Substances in Electrical and Electronic Equipment (RoHS) directive 2011/65/EU.

Note4. With ripple satisfying the following conditions: dv/dt swing ≤ ±5 V/μs, Variation ≤ 2 V peak to peak



PM200RG1C120

HIGH POWER SWITCHING USE
INSULATED TYPE

PRECAUTIONS FOR TESTING

1. Before applying any control supply voltage (V_D), the input terminals should be pulled up by resistors, etc. to their corresponding supply voltage and each input signal should be kept off state.

After this, the specified ON and OFF level setting for each input signal should be done.

2. When performing "SC" tests, the turn-off surge voltage spike at the corresponding protection operation should not be allowed to rise above V_{CES} rating of the device.

(These test should not be done by using a curve tracer or its equivalent.)

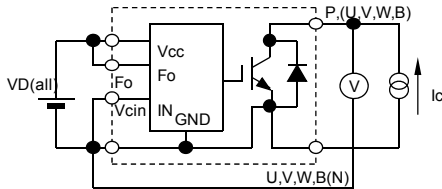

Fig.1 V_{CESat} Test

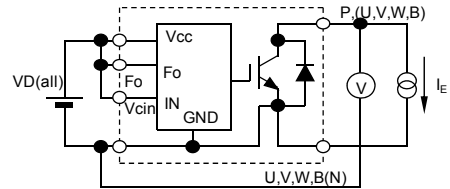

Fig.2 V_{EC} Test

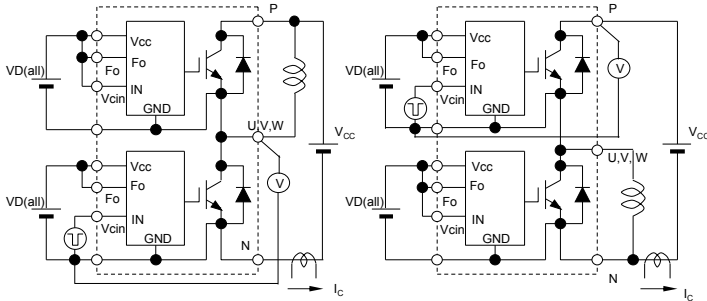

Fig.3 Switching time and SC test circuit

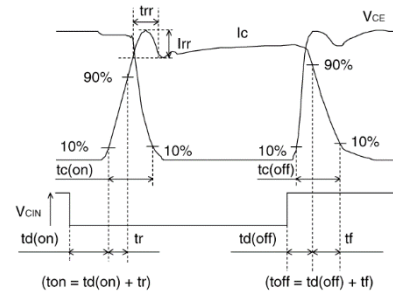

Fig.4 Switching time test waveform

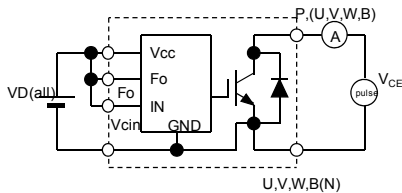

Fig.5 I_{CES} Test

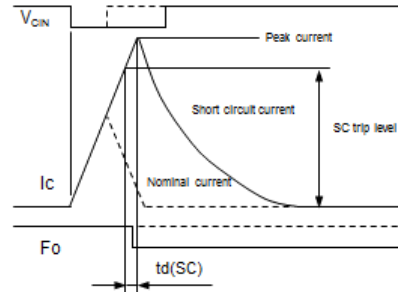
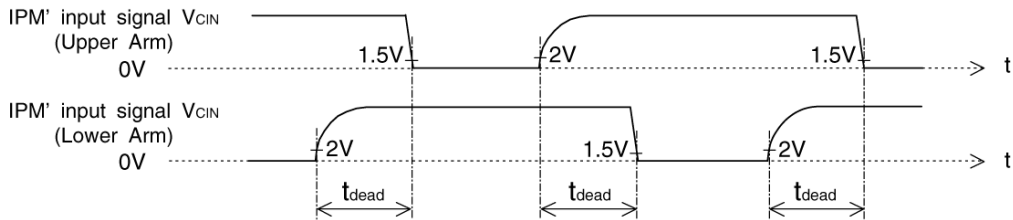

Fig.6 SC test waveform



1.5V: Input on threshold voltage $V_{th(on)}$ typical value, 2V: Input off threshold voltage $V_{th(off)}$ typical value

Fig. 7 Dead time measurement point example

PM200RG1C120

HIGH POWER SWITCHING USE
INSULATED TYPE



Fig. 8 Application Example Circuit

NOTES FOR STABLE AND SAFE OPERATION ;

- Design the PCB pattern to minimize wiring length between opto-coupler and IPM's input terminal, and also to minimize the stray capacity between the input and output wirings of opto-coupler.
- Connect low impedance capacitor between the Vcc and GND terminal of each fast switching opto-coupler.
- Fast switching opto-couplers: $t_{PLH}, t_{PHL} \leq 0.8\mu s$, Use High CMR type.
- Slow switching opto-coupler: CTR > 100% (*can be applied to Brake part input signal, in this case, resistor should be selected properly).
- Use 4 isolated control power supplies (V_D). Also, care should be taken to minimize the instantaneous voltage charge of the power supply.
- Make inductance of DC bus line as small as possible, and minimize surge voltage using snubber capacitor between P and N terminal.

PM200RG1C120

HIGH POWER SWITCHING USE
INSULATED TYPE

PERFORMANCE CURVES Inverter part

COLLECTOR-EMITTER SATURATION VOLTAGE (VS. I_C) CHARACTERISTICS (TYPICAL)

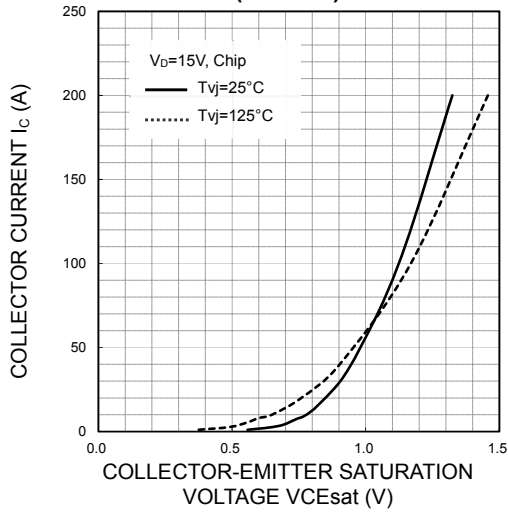

FREE WHEELING DIODE FORWARD CHARACTERISTICS (TYPICAL)

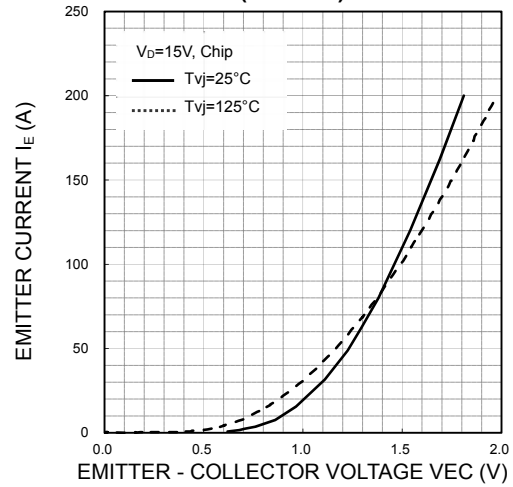

SWITCHING TIME (t_{on} , t_{off}) CHARACTERISTICS (TYPICAL)

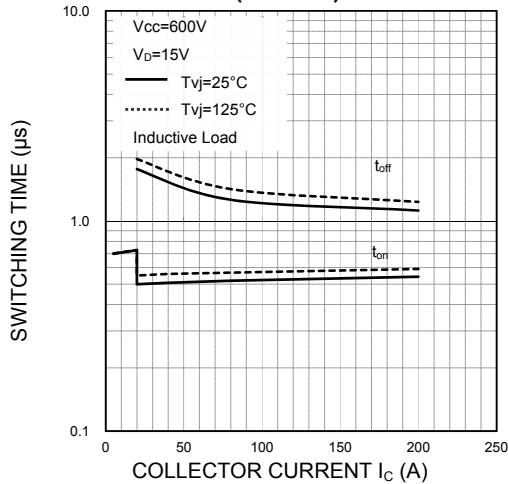

SWITCHING TIME ($t_{c(on)}$, $t_{c(off)}$) CHARACTERISTICS (TYPICAL)

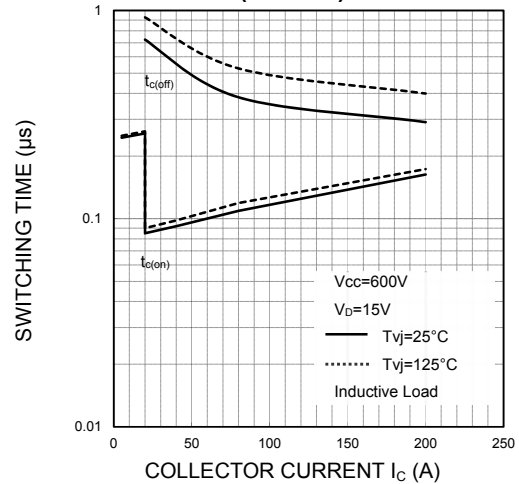

SWITCHING ENERGY E_{on} CHARACTERISTICS (TYPICAL)

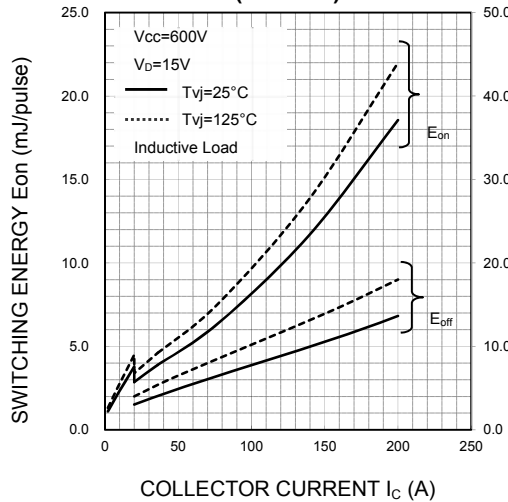

FREE WHEELING DIODE REVERSE RECOVERY ENERGY CHARACTERISTICS (TYPICAL)

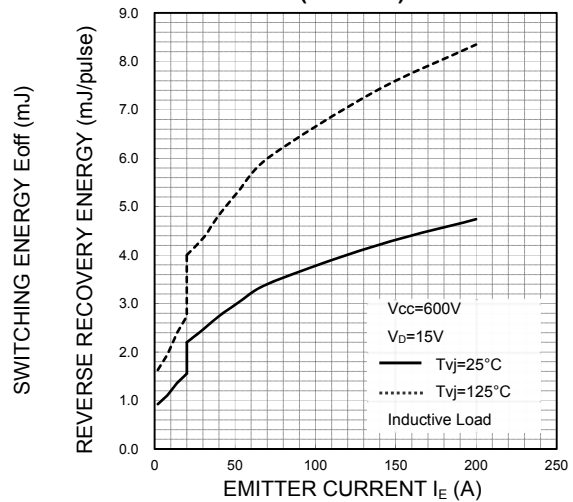

PM200RG1C120

HIGH POWER SWITCHING USE
INSULATED TYPE

FREE WHEELING DIODE REVERSE RECOVERY CHARACTERISTICS (TYPICAL)

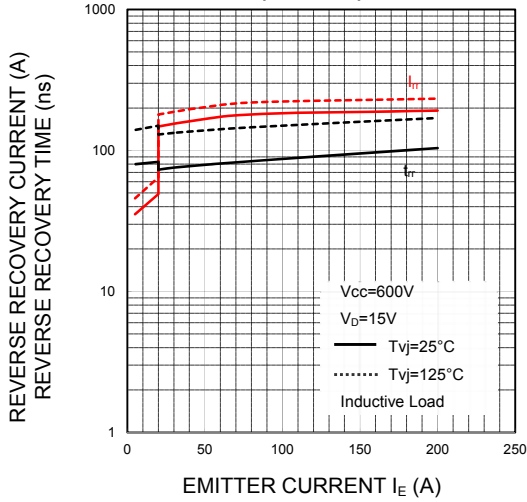

I_D VS. f_c CHARACTERISTICS (TYPICAL, MAXIMUM)

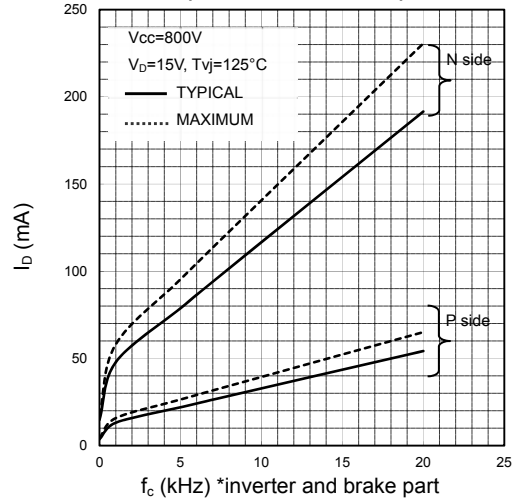

UV TRIP LEVEL VS. T_{vj} CHARACTERISTICS (TYPICAL)

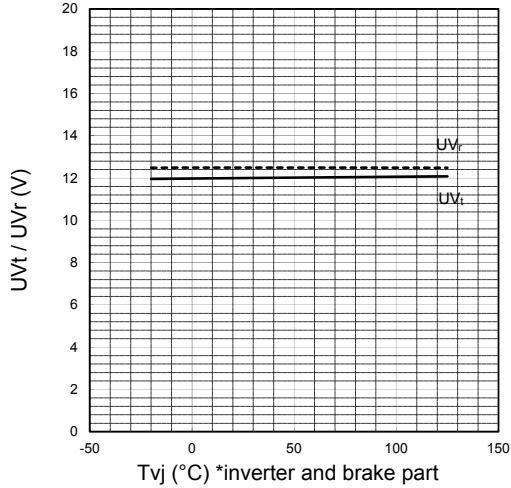

SC TRIP LEVEL VS. T_{vj} CHARACTERISTICS (TYPICAL)

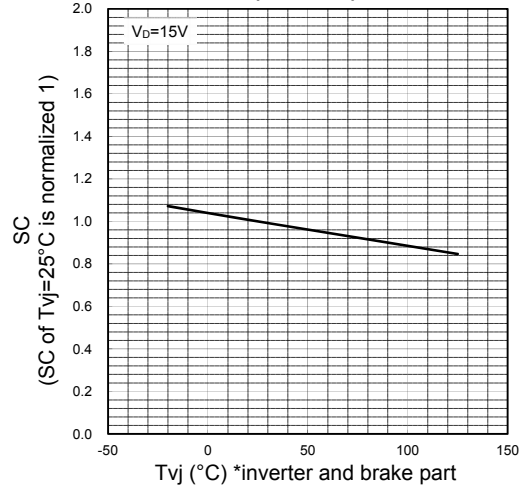

TRANSIENT THERMAL IMPEDANCE CHARACTERISTICS (TYPICAL)

| i | 1 | 2 | 3 | 4 |
|-------------|-----------|--------|--------|--------|
| R_{ti} | 0.0124 | 0.0739 | 0.3505 | 0.5632 |
| t_i (sec) | 1.961E-05 | 0.0014 | 0.0179 | 0.0944 |

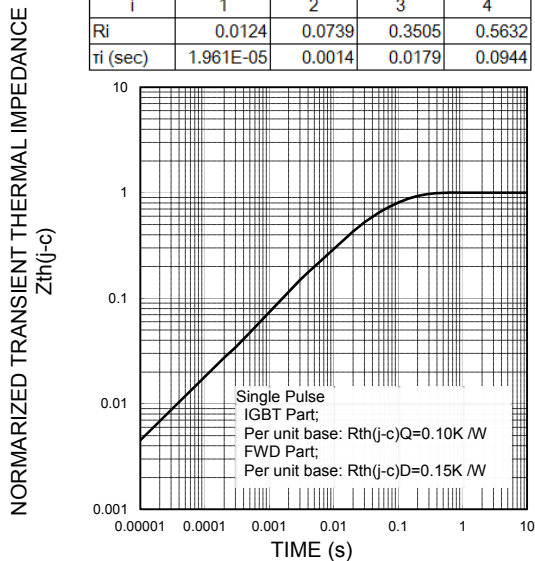

PM200RG1C120

HIGH POWER SWITCHING USE
INSULATED TYPE

PERFORMANCE CURVES

Brake part

COLLECTOR-EMITTER SATURATION VOLTAGE (VS. I_c) CHARACTERISTICS (TYPICAL)

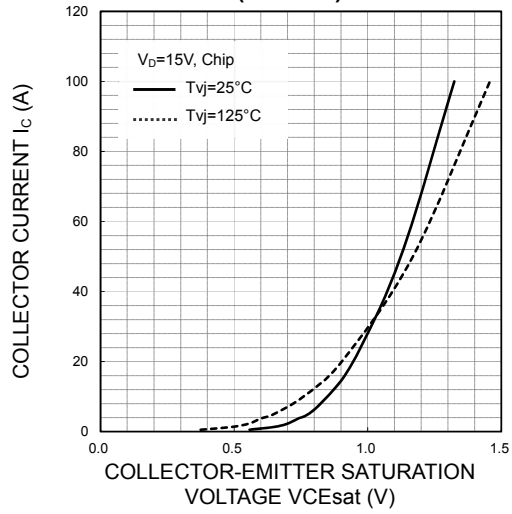

FREE WHEELING DIODE FORWARD CHARACTERISTICS (TYPICAL)

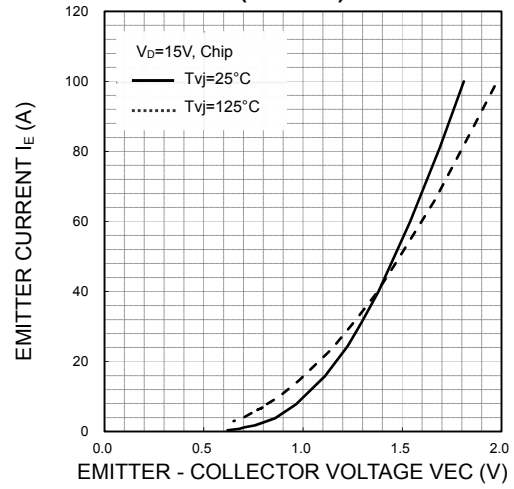

TRANSIENT THERMAL IMPEDANCE CHARACTERISTICS (TYPICAL)

| i | 1 | 2 | 3 | 4 |
|----------------|-----------|--------|--------|--------|
| R_i | 0.0124 | 0.0739 | 0.3505 | 0.5632 |
| τ_i (sec) | 1.961E-05 | 0.0014 | 0.0179 | 0.0944 |

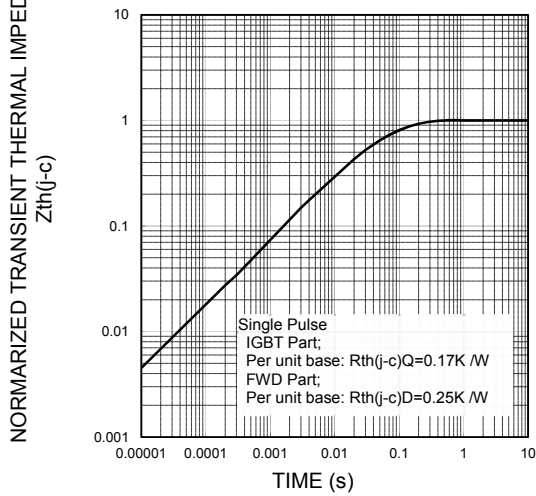

Keep safety first in your circuit designs!

This product is designed for industrial application purpose. The performance, the quality and support level of the product is guaranteed by "Customer's Std. Spec."

Mitsubishi Electric Corporation puts its reasonable effort into making semiconductor products better and more reliable, but there is always the possibility that trouble may occur with them by the reliability lifetime such as Power Cycle, Thermal Cycle or others, or to be used under special circumstances (e.g. high humidity, dusty, salty, highlands, environment with lots of organic matter / corrosive gas / explosive gas, or situation which terminal of semiconductor products is received strong mechanical stress).

In the customer's research and development, please evaluate it not only with a single semiconductor product but also in the entire system, and judge whether it's applicable. Furthermore, trouble with semiconductors may lead to personal injury, fire or property damage. Remember to give due consideration to safety when making your circuit designs, with appropriate measures such as (i) placement of substitutive, auxiliary circuits (e.g. appropriate fuse or circuit breaker between a power supply and semiconductor products), (ii) use of non-flammable material or (iii) prevention against any malfunction or mishap.

Notes regarding these materials

- These materials are intended as a reference to assist our customers in the selection of the Mitsubishi semiconductor product best suited to the customer's application; they do not convey any license under any intellectual property rights, or any other rights, belonging to Mitsubishi Electric Corporation or a third party.

- Mitsubishi Electric Corporation assumes no responsibility for any damage, or infringement of any third-party's rights, originating in the use of any product data, diagrams, charts, or circuit application examples contained in these materials.

- All information contained in these materials, including product data, diagrams and charts represents information on products at the time of publication of these materials, and are subject to change by Mitsubishi Electric Corporation without notice due to product improvements or other reasons. It is therefore recommended that customers contact Mitsubishi Electric Corporation or an authorized Mitsubishi Semiconductor product distributor for the latest product information before purchasing a product listed herein.

The information described here may contain technical inaccuracies or typographical errors. Mitsubishi Electric Corporation assumes no responsibility for any damage, liability, or other loss rising from these inaccuracies or errors.

Please also pay attention to information published by Mitsubishi Electric Corporation by various means, including the Mitsubishi Semiconductor home page (www.MitsubishiElectric.com/semiconductors/).

- When using any or all of the information contained in these materials, including product data, diagrams, and charts, please be sure to evaluate all information as a total system before making a final decision on the applicability of the information and products. Mitsubishi Electric Corporation assumes no responsibility for any damage, liability or other loss resulting from the information contained herein.

- Mitsubishi Electric Corporation semiconductors are not designed or manufactured for use in a device or system that is used under circumstances in which human life is potentially at stake. Therefore, this product should not be used in such applications. Please contact Mitsubishi Electric Corporation or an authorized Mitsubishi Semiconductor product distributor when considering the use of a product contained herein for any specific purposes, such as apparatus or systems for transportation, vehicular, medical, aerospace, nuclear, or undersea repeater use.

- In the case of new requirement is available, this material will be revised upon consultation.

- The prior written approval of Mitsubishi Electric Corporation is necessary to reprint or reproduce in whole or in part these materials.

- If these products or technologies are subject to the Japanese export control restrictions, they must be exported under a license from the Japanese government and cannot be imported into a country other than the approved destination. Any diversion or re-export contrary to the export control laws and regulations of Japan and/or the country of destination is prohibited.

- Please contact Mitsubishi Electric Corporation or an authorized Mitsubishi Semiconductor product distributor for further details on these materials or the products contained therein.

Generally the listed company name and the brand name are the trademarks or registered trademarks of the respective companies.

Note:

The characteristics curves are presented for reference only and not guaranteed by production test, unless otherwise noted.