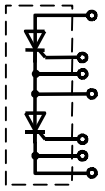
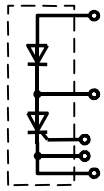
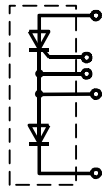

Thyristor/Diode Modules M## 551

Absolute Maximum Ratings

V_{RRM} V_{DRM} [V]	 MCC	 MCD	 MDC
1200	551-12io2	551-12io2	551-12io2
1400	551-14io2	551-14io2	551-14io2
1600	551-16io2	551-16io2	551-16io2

	VOLTAGE RATINGS	MAXIMUM LIMITS	UNITS
V_{DRM}	Repetitive peak off-state voltage ¹⁾	1200-1600	V
V_{DSM}	Non-repetitive peak off-state voltage ¹⁾	1300-1700	V
V_{RRM}	Repetitive peak reverse voltage ¹⁾	1200-1600	V
V_{RSM}	Non-repetitive peak reverse voltage ¹⁾	1300-1700	V

	OTHER RATINGS	MAXIMUM LIMITS	UNITS
$I_{T(AV)M}$	Maximum average on-state current, $T_C = 85^\circ\text{C}$ ²⁾	560	A
$I_{T(AV)M}$	Maximum average on-state current, $T_C = 100^\circ\text{C}$ ²⁾	385	A
$I_{T(RMS)M}$	Nominal RMS on-state current, $T_C = 55^\circ\text{C}$ ²⁾	1336	A
$I_{T(d.c.)}$	D.C. on-state current, $T_C = 55^\circ\text{C}$	1053	A
I_{TSM}	Peak non-repetitive surge $t_p = 10$ ms, $V_{RM} = 60\%V_{RRM}$ ³⁾	18.0	kA
I_{TSM2}	Peak non-repetitive surge $t_p = 10$ ms, $V_{RM} \leq 10$ V ³⁾	19.8	kA
I^2t	I^2t capacity for fusing $t_p = 10$ ms, $V_{RM} = 60\%V_{RRM}$ ³⁾	1.62×10^6	A^2s
I^2t	I^2t capacity for fusing $t_p = 10$ ms, $V_{RM} \leq 10$ V ³⁾	1.96×10^6	A^2s
$(di/dt)_{cr}$	Critical rate of rise of on-state current (repetitive) ⁴⁾	150	$\text{A}/\mu\text{s}$
$(di/dt)_{cr}$	Critical rate of rise of on-state current (non-repetitive) ⁴⁾	300	$\text{A}/\mu\text{s}$
V_{RGM}	Peak reverse gate voltage	5	V
$P_{G(AV)}$	Mean forward gate power	4	W
P_{GM}	Peak forward gate power	30	W
V_{ISOL}	Isolation Voltage ⁵⁾	3000	V
$T_{vj\ op}$	Operating temperature range	-40 to +125	$^\circ\text{C}$
T_{stg}	Storage temperature range	-40 to +125	$^\circ\text{C}$

Notes:

- De-rating factor of 0.13% per $^\circ\text{C}$ is applicable for T_{vj} below 25°C .
- Single phase; 50 Hz, 180° half-sinewave.
- Half-sinewave, 125°C T_{vj} initial.
- $V_D = 67\% V_{DRM}$, $I_{FG} = 2$ A, $t_r \leq 0.5\mu\text{s}$, $T_C = 125^\circ\text{C}$.
- AC RMS voltage, 50 Hz, 1min test

Characteristics

	PARAMETER	MIN.	TYP.	MAX.	TEST CONDITIONS ¹⁾	UNITS
V_{TM}	Maximum peak on-state voltage	-	-	1.30	$I_{TM} = 1700$ A	V
V_{TM}	Maximum peak on-state voltage	-	-	1.24	$I_{TM} = 1500$ A	V
V_{T0}	Threshold voltage	-	-	0.817		V
r_T	Slope resistance	-	-	0.242		m Ω
$(dv/dt)_{cr}$	Critical rate of rise of off-state voltage	1000	-	-	$V_D = 80\% V_{DRM}$, linear ramp, Gate o/c	V/ μ s
I_{DRM}	Peak off-state current	-	-	70	Rated V_{DRM}	mA
I_{RRM}	Peak reverse current	-	-	70	Rated V_{RRM}	mA
V_{GT}	Gate trigger voltage	-	-	3.0	$T_{vj} = 25^\circ\text{C}$, $V_D = 10$ V, $I_T = 3$ A	V
I_{GT}	Gate trigger current	-	-	300		mA
V_{GD}	Gate non-trigger voltage	0.25	-	-	$67\% V_{DRM}$	V
I_H	Holding current	-	-	1000	$V_D = 12$ V, $T_{vj} = 25^\circ\text{C}$	mA
t_{gd}	Gate controlled turn-on delay time	-	0.6	1.5	$I_{FG} = 2$ A, $t_r = 0.5$ μ s, $V_D = 67\%V_{DRM}$, $I_{TM} = 2000$ A, $di/dt = 10$ A/ μ s, $T_{vj} = 25^\circ\text{C}$	μ s
t_{gt}	Turn-on time	-	1.2	2.5		
Q_{rr}	Recovered Charge	-	1650	2000	$I_{TM} = 1000$ A, $t_p = 1$ ms, $di/dt = 10$ A/ μ s, $V_R = 50$ V	μ C
Q_{ra}	Recovered Charge, 50% chord	-	1000	-		μ C
I_{rm}	Reverse recovery current	-	105	-		A
t_{rr}	Reverse recovery time, 50% chord	-	19	-		μ s
t_q	Turn-off time	-	200	-	$I_{TM} = 1000$ A, $t_p = 1$ ms, $di/dt = 10$ A/ μ s, $V_R = 50$ V, $V_{DR} = 80\%V_{DRM}$, $dv_{DR}/dt = 20$ V/ μ s	μ s
		-	300	-	$I_{TM} = 1000$ A, $t_p = 1$ ms, $di/dt = 10$ A/ μ s, $V_R = 50$ V, $V_{DR} = 80\%V_{DRM}$, $dv_{DR}/dt = 200$ V/ μ s	
R_{thJC}	Thermal resistance, junction to case	-	-	0.062	Single Thyristor	K/W
		-	-	0.031	Whole Module	K/W
R_{thCH}	Thermal resistance, case to heatsink	-	-	0.02	Single Thyristor	K/W
		-	-	0.01	Whole Module	K/W
F_1	Mounting force (to heatsink)	4.25	-	5.75	2)	Nm
F_2	Mounting force (to terminals)	10.2	-	13.8		Nm
W_t	Weight	-	1.5	-		kg

Notes:

- 1) Unless otherwise indicated $T_{vj} = 125^\circ\text{C}$.
- 2) Screws must be lubricated.

Notes on Ratings and Characteristics

1.0 Voltage Grade Table

Voltage Grade	V_{DRM} V_{RRM} V	V_{DSM} V_{RSM} V	V_D V_R DC V
12	1200	1300	900
14	1400	1500	1050
16	1600	1700	1200

2.0 Extension of Voltage Grades

This report is applicable to other voltage grades when supply has been agreed by Sales/Production.

3.0 De-rating Factor

A blocking voltage de-rating factor of 0.13%/°C is applicable to this device for T_{vj} below 25°C.

4.0 Repetitive dv/dt

Standard dv/dt is 1000V/μs.

5.0 Snubber Components

When selecting snubber components, care must be taken not to use excessively large values of snubber capacitor or excessively small values of snubber resistor. Such excessive component values may lead to device damage due to the large resultant values of snubber discharge current. If required, please consult the factory for assistance.

6.0 Rate of rise of on-state current

The maximum un-primed rate of rise of on-state current must not exceed 300A/μs at any time during turn-on on a non-repetitive basis. For repetitive performance, the on-state rate of rise of current must not exceed 150A/μs at any time during turn-on. Note that these values of rate of rise of current apply to the total device current including that from any local snubber network.

7.0 Gate Drive

The nominal requirement for a typical gate drive is illustrated below. An open circuit voltage of at least 30V is assumed. This gate drive must be applied when using the full di/dt capability of the device.

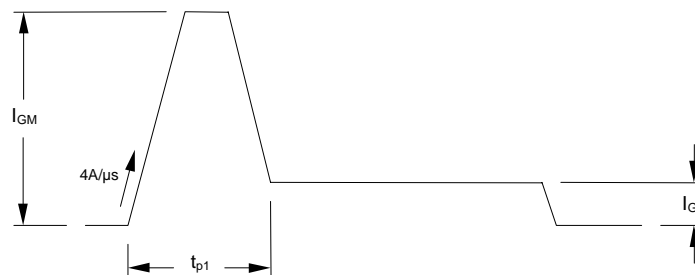

The magnitude of I_{GM} should be between five and ten times I_{GT} , which is shown on page 2. Its duration (t_{p1}) should be 20μs or sufficient to allow the anode current to reach ten times I_L , whichever is greater. Otherwise, an increase in pulse current could be needed to supply the necessary charge to trigger. The 'back-porch' current I_G should remain flowing for the same duration as the anode current and have a magnitude in the order of 1.5 times I_{GT} .

8.0 Computer Modelling Parameters

8.1 Thyristor Dissipation Calculations

$$I_{AV} = \frac{-V_{T0} + \sqrt{V_{T0}^2 + 4 \cdot ff^2 \cdot r_T \cdot W_{AV}}}{2 \cdot ff^2 \cdot r_T} \quad \text{and:} \quad W_{AV} = \frac{\Delta T}{R_{th}}$$

$$\Delta T = T_{j \max} - T_K$$

Where $V_{T0} = 0.817 \text{ V}$, $r_T = 0.242 \text{ m}\Omega$.

R_{th} = Supplementary thermal impedance, see table below and

ff = Form factor, see table below.

Supplementary Thermal Impedance							
Conduction Angle	30°	60°	90°	120°	180°	270°	d.c.
Square wave	0.0702	0.0685	0.0679	0.0668	0.0658	0.0637	0.0620
Sine wave	0.0677	0.0673	0.0664	0.0655	0.0650		

Form Factors							
Conduction Angle	30°	60°	90°	120°	180°	270°	d.c.
Square wave	3.464	2.449	2	1.732	1.414	1.149	1
Sine wave	3.98	2.778	2.22	1.879	1.57		

8.2 Calculating thyristor V_T using ABCD Coefficients

The on-state characteristic I_T vs. V_T , on page 6 is represented by a set of constants A, B, C, D, forming the coefficients of the representative equation for V_T in terms of I_T given below:

$$V_T = A + B \cdot \ln(I_T) + C \cdot I_T + D \cdot \sqrt{I_T}$$

The constants, derived by curve fitting software, are given below for both hot and cold characteristics. The resulting values for V_T agree with the true device characteristic over a current range, which is limited to that plotted.

25°C Coefficients		125°C Coefficients	
A	0.8741218	A	0.5628134
B	-9.489837×10^{-3}	B	4.538498×10^{-3}
C	1.792661×10^{-4}	C	1.769363×10^{-4}
D	3.679706×10^{-3}	D	9.776853×10^{-3}

8.3 D.C. Thermal Impedance Calculation

$$r_t = \sum_{p=1}^{p=n} r_p \cdot \left(1 - e^{-\frac{t}{\tau_p}} \right)$$

Where $p = 1$ to n and:

- n = number of terms in the series
- t = Duration of heating pulse in seconds
- r_t = Thermal resistance at time t
- r_p = Amplitude of p_{th} term
- τ_p = Time Constant of r_{th} term

The coefficients for this device are shown in the table below:

D.C.					
Term	1	2	3	4	5
r_p	1.37×10^{-3}	4.86×10^{-3}	0.0114	0.0223	0.0221
τ_p	7.6×10^{-4}	8.6×10^{-3}	0.101	0.56	3.12

9.0 Reverse recovery ratings

(i) Q_{ra} is based on 50% I_{RM} chord as shown in Fig. 1

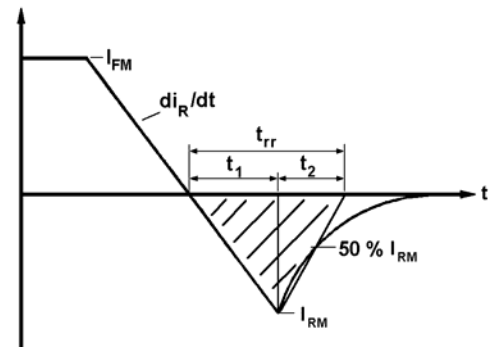

Fig. 1

(ii) Q_{rr} is based on a $150 \mu s$ integration time i.e.

$$Q_{rr} = \int_0^{150 \mu s} i_{rr} \cdot dt$$

(iii)

$$K \text{ Factor} = \frac{t_1}{t_2}$$

Curves

Figure 1 – On-state characteristics of Limit device

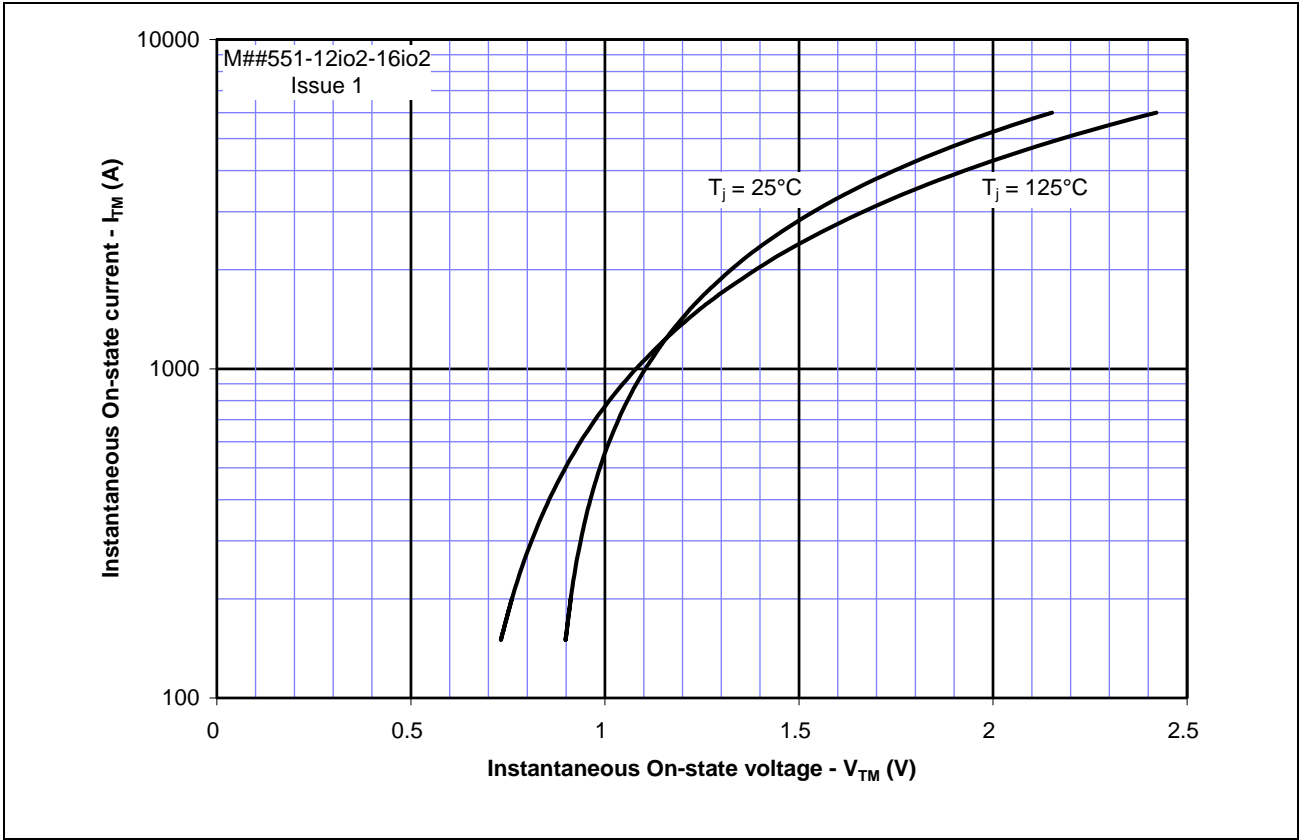

Figure 2 – Gate characteristics – Trigger limits

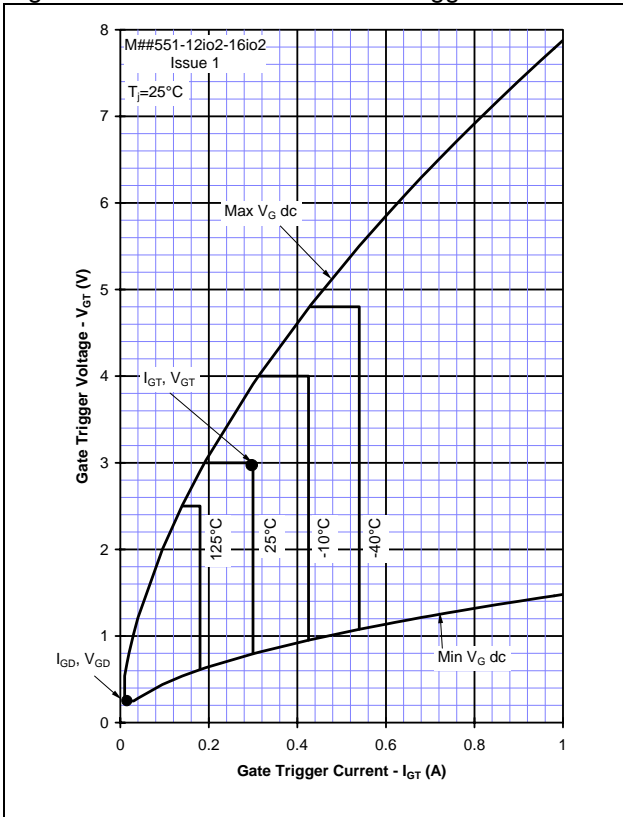

Figure 3 – Gate characteristics – Power curves

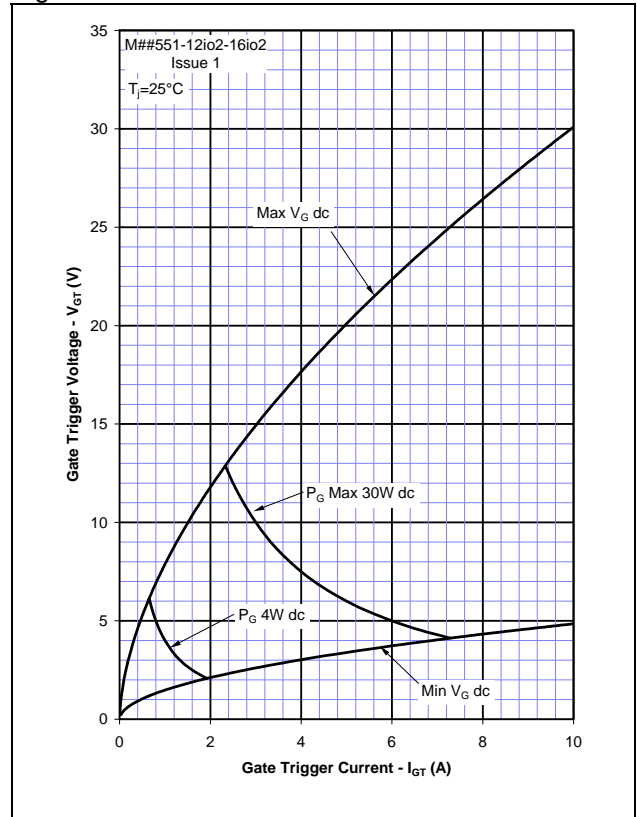

Figure 4 - Total recovered charge, Q_{rr}

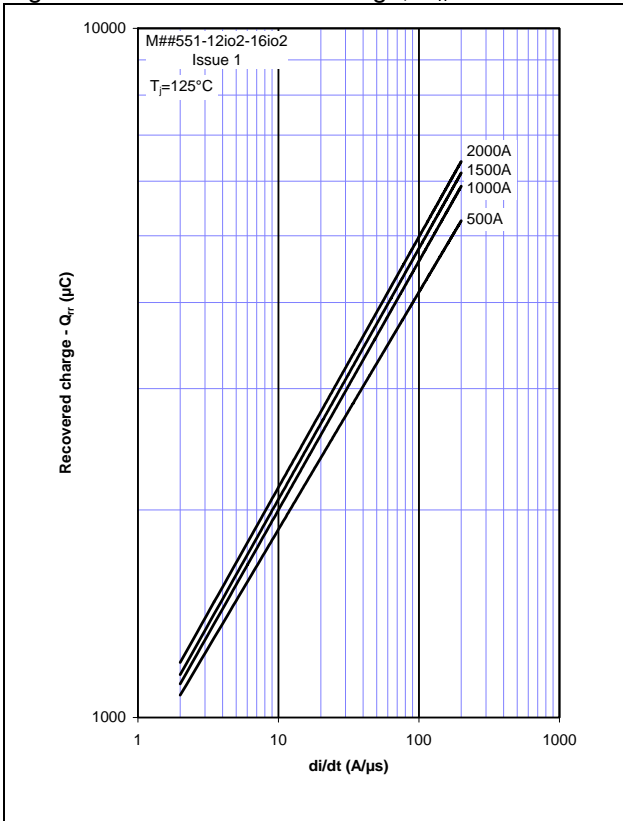

Figure 5 - Recovered charge, Q_{ra} (50% chord)

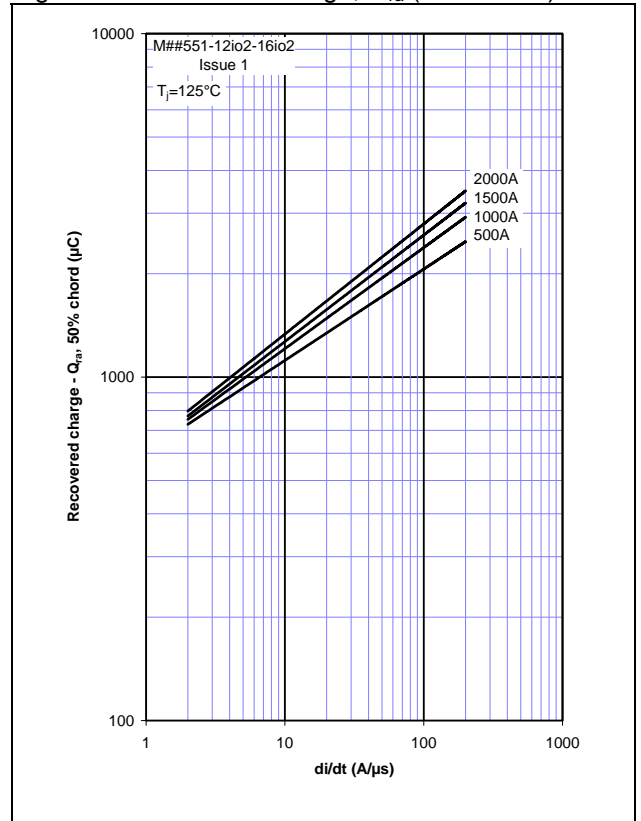

Figure 6 - Peak reverse recovery current, I_{rm}

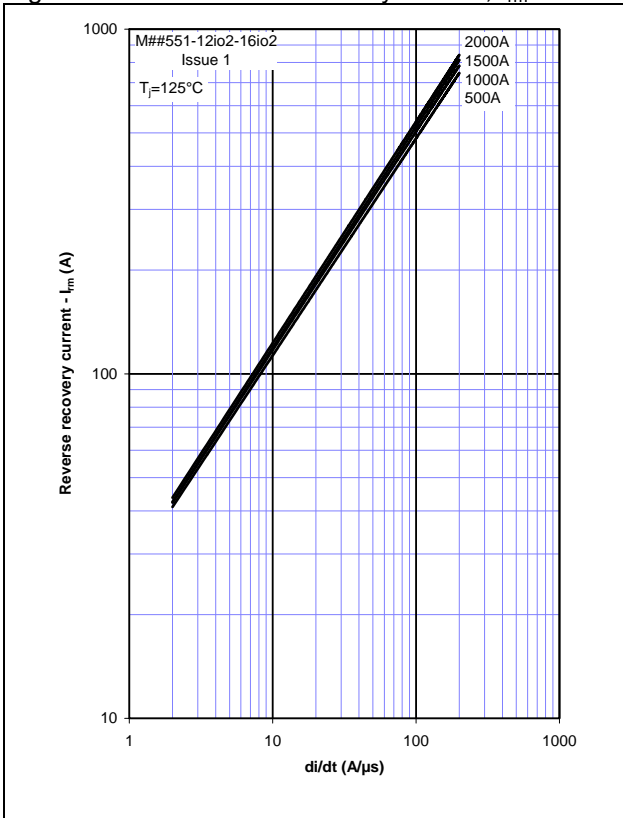

Figure 7 - Maximum recovery time, t_{rr} (50% chord)

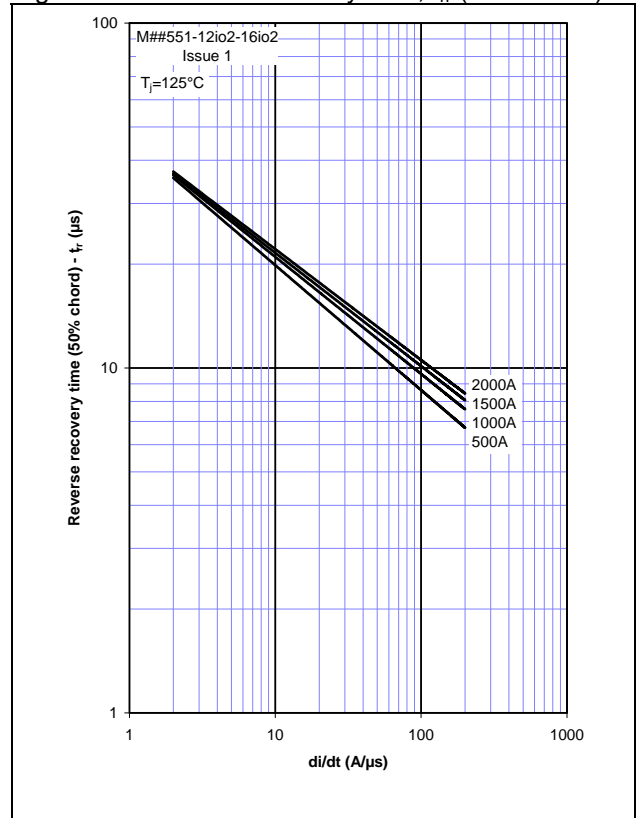

Figure 8 – On-state current vs. Power dissipation – Sine wave

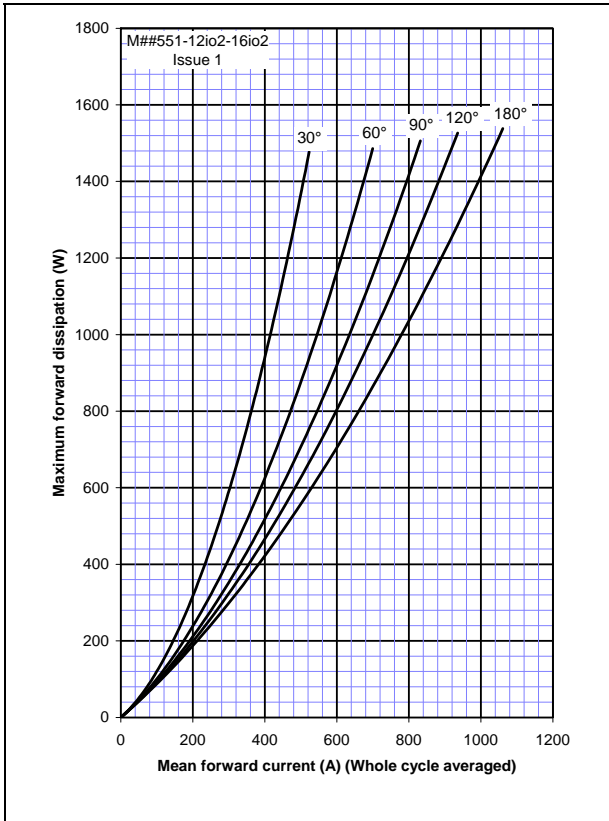

Figure 9 – On-state current vs. Heatsink temperature – Sine wave

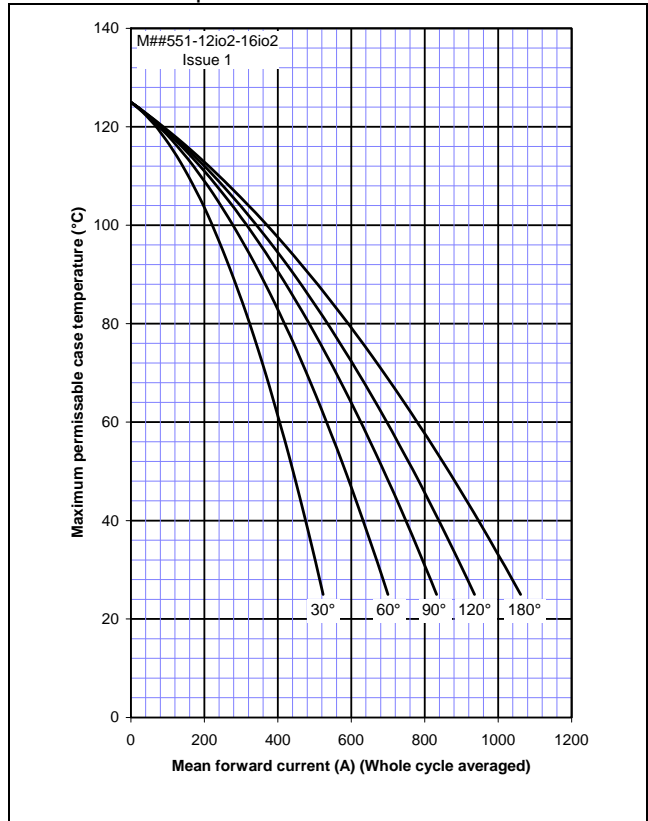

Figure 10 – On-state current vs. Power dissipation – Square wave

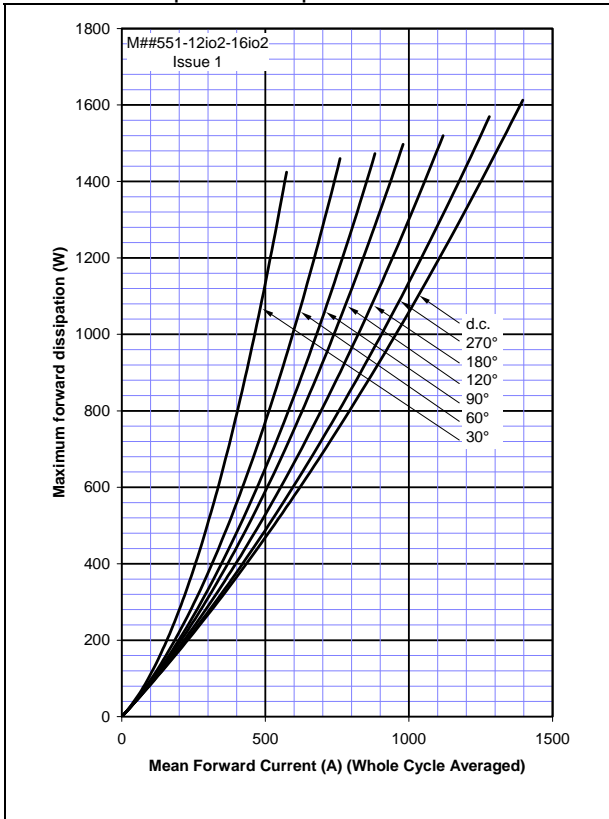

Figure 11 – On-state current vs. Heatsink temperature – Square wave

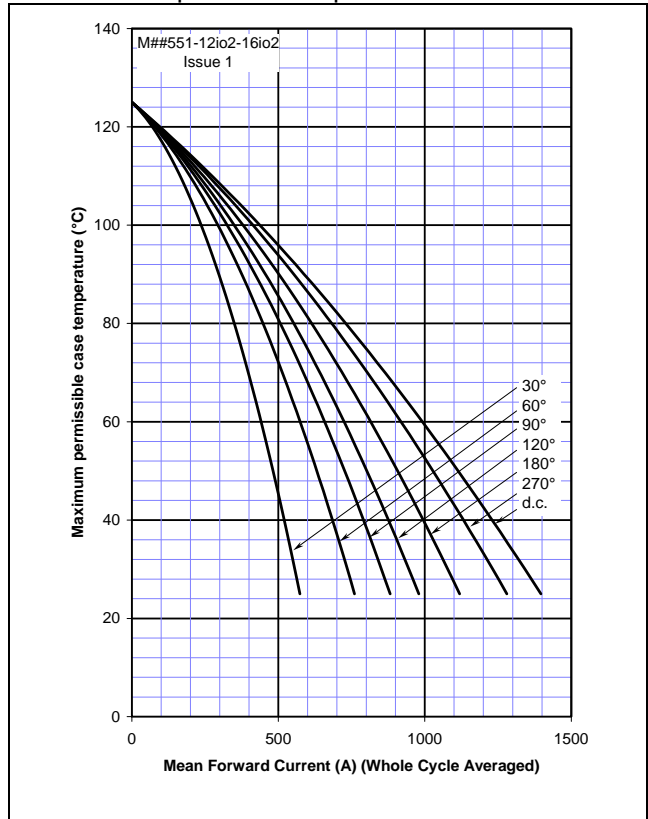

Figure 12 – Maximum surge and I²t Ratings

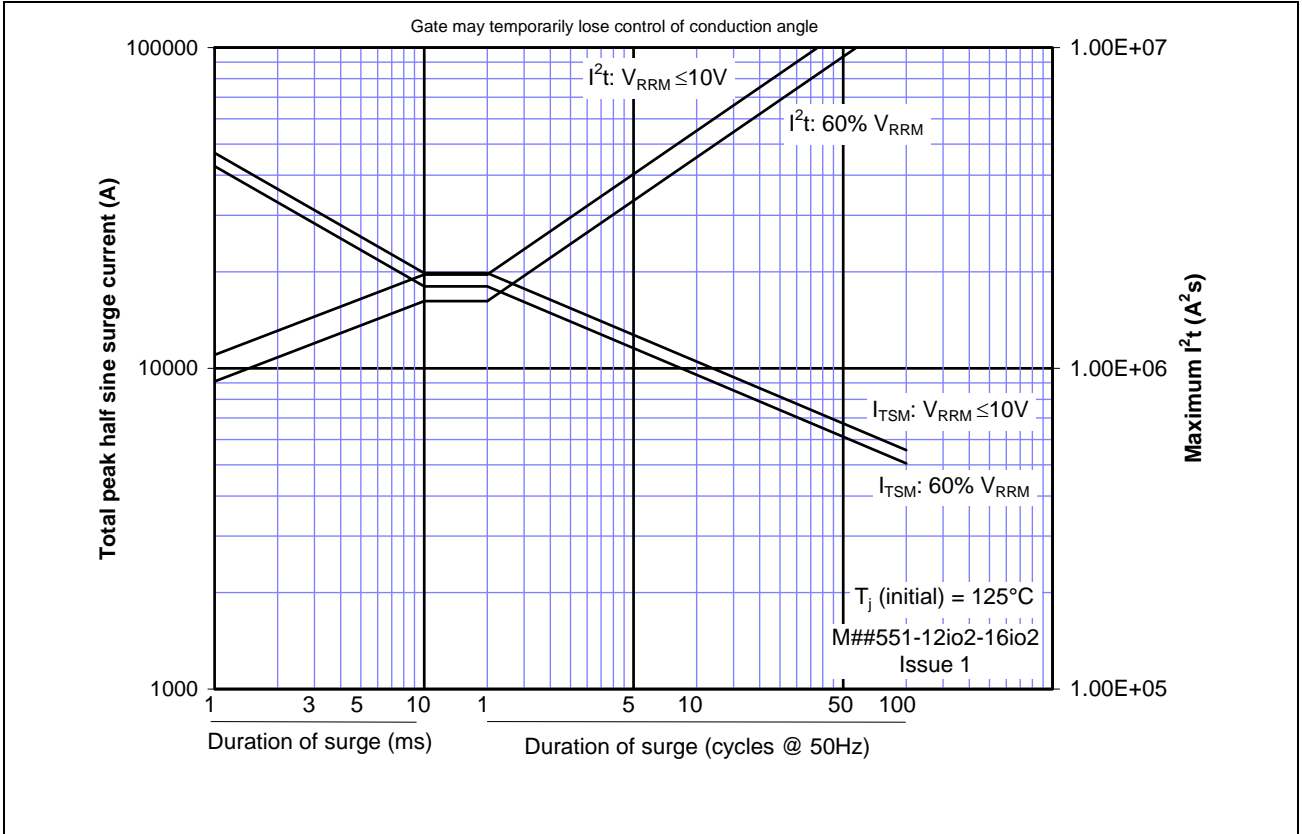
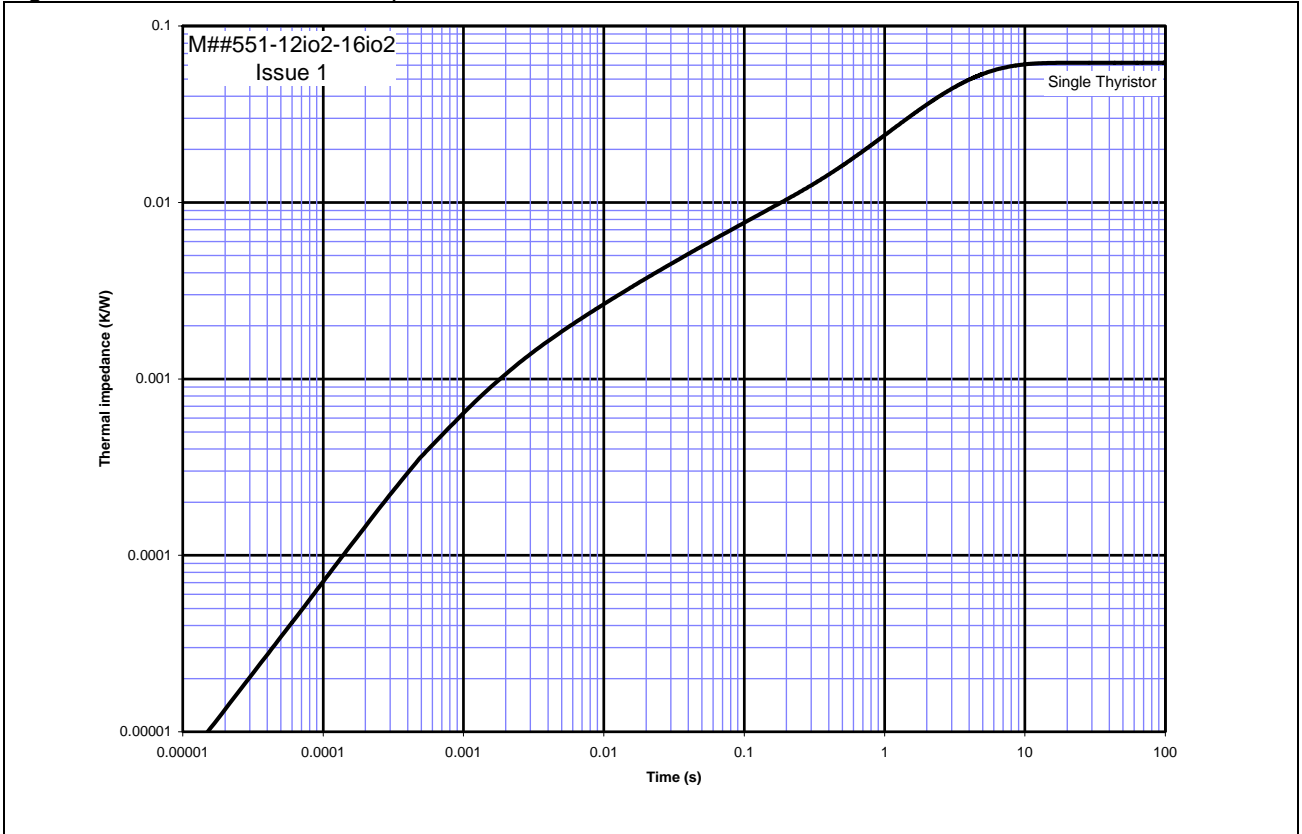
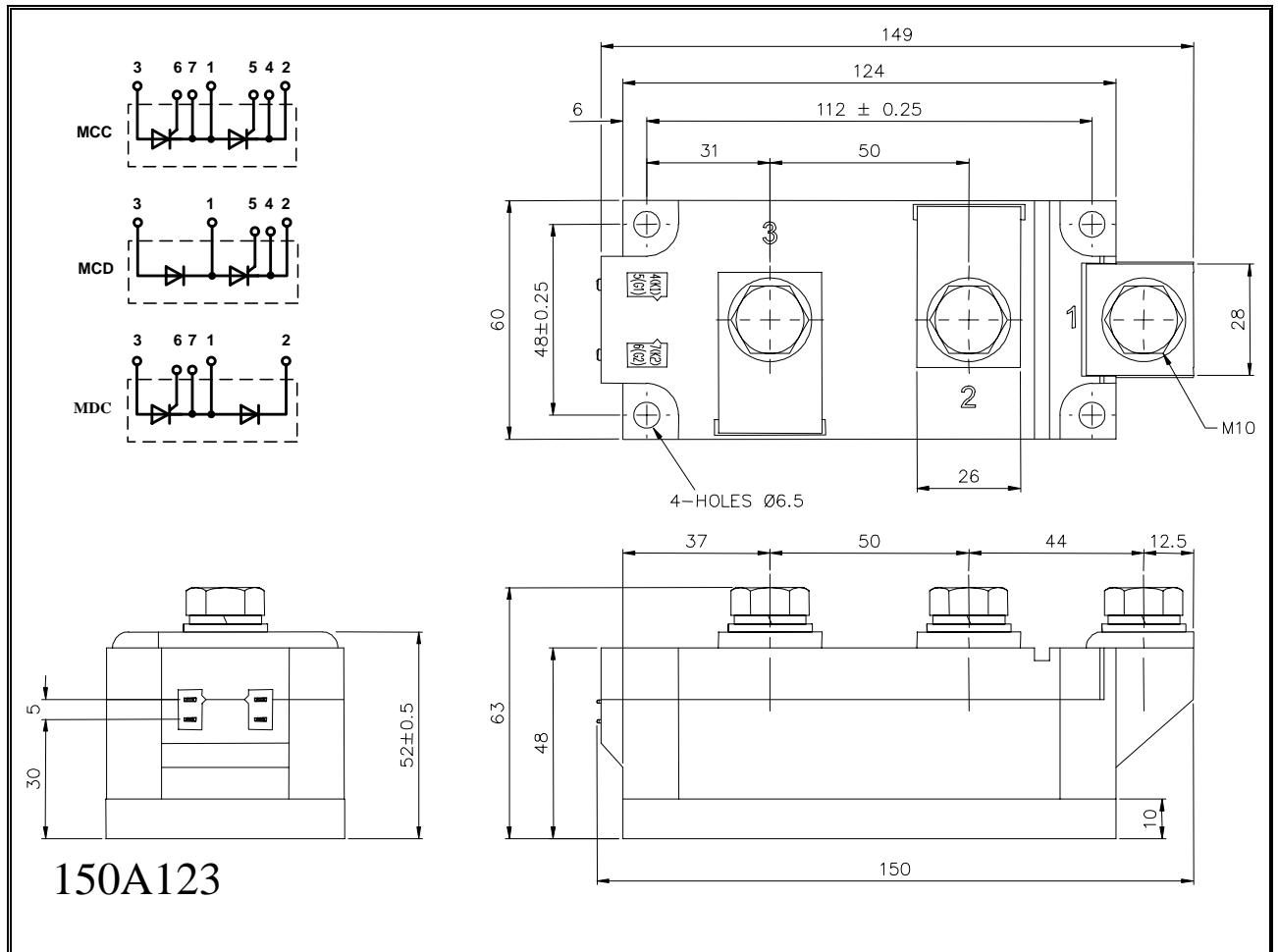

Figure 13 – Transient thermal impedance



Outline Drawing & Ordering Information



ORDERING INFORMATION					
M	##	551	◆◆	io	2
Fixed Type Code	Configuration code CC, CD or DC	Fixed Type Code	Voltage code $V_{RRM}/100$ 12-16	i = Critical dv/dt 1000 V/μs o = Typical turn-off time	Fixed Version Code

Typical order code: MCC551-14io2– MCC configuration, 1400V V_{RRM}

IXYS Semiconductor GmbH
Edisonstraße 15
D-68623 Lampertheim
Tel: +49 6206 503-0
Fax: +49 6206 503-627
E-mail: marcom@ixys.de



www.ixys.com

IXYS Corporation
1590 Buckeye Drive
Milpitas CA 95035 7418 USA
Tel: +1 (408) 547 9000
Fax: +1 (408) 496 0670
E-mail: sales@ixys.net

WESTCODE

An IXYS Company

www.westcode.com

Westcode Semiconductors Ltd
Langley Park Way, Langley Park,
Chippenham, Wiltshire, SN15 1GE.
Tel: +44 (0)1249 444524
Fax: +44 (0)1249 659448
E-mail: WSL.sales@westcode.com

IXYS Long Beach, Inc
2500 Mira Mar Ave, Long Beach
CA 90815
Tel: +1 (562) 296 6584
Fax: +1 (562) 296 6585
E-mail: service@ixyslongbeach.com

The information contained herein is confidential and is protected by Copyright. The information may not be used or disclosed except with the written permission of and in the manner permitted by the proprietors IXYS Semiconductors GmbH.
In the interest of product improvement, IXYS reserves the right to change specifications at any time without prior notice.

© IXYS Semiconductor GmbH.