



<IGBT Modules>

# CM225DX-34T/CM225DXP-34T

**HIGH POWER SWITCHING USE  
INSULATED TYPE**

 <p>DX</p>	<p>Collector current <math>I_C</math> ..... <b>225 A</b>            Collector-emitter voltage <math>V_{CES}</math> ..... <b>1700 V</b>            Maximum junction temperature <math>T_{vjmax}</math> ..... <b>175 °C</b></p> <ul style="list-style-type: none"> <li>• Flat base type</li> <li>• Copper base plate (Nickel-plating)</li> <li>• RoHS Directive compliant</li> <li>• Tin-plating pin terminals</li> </ul>
 <p>DXP</p>	<p>Collector current <math>I_C</math> ..... <b>225 A</b>            Collector-emitter voltage <math>V_{CES}</math> ..... <b>1700 V</b>            Maximum junction temperature <math>T_{vjmax}</math> ..... <b>175 °C</b></p> <ul style="list-style-type: none"> <li>• Flat base type</li> <li>• Copper base plate (Nickel-plating)</li> <li>• RoHS Directive compliant</li> <li>• Tin-plating pressfit terminals</li> </ul>
<p>dual switch (half-bridge)</p> <ul style="list-style-type: none"> <li>• UL Recognized under UL1557, File No. E323585</li> </ul>	

## APPLICATION

AC Motor Control, Motion/Servo Control, Power supply, etc.

## OPTION (Below options are available.)

- PC-TIM (Phase Change Thermal Interface Material) pre-apply
- $V_{CEsat}$  selection for parallel connection

## INTERNAL CONNECTION

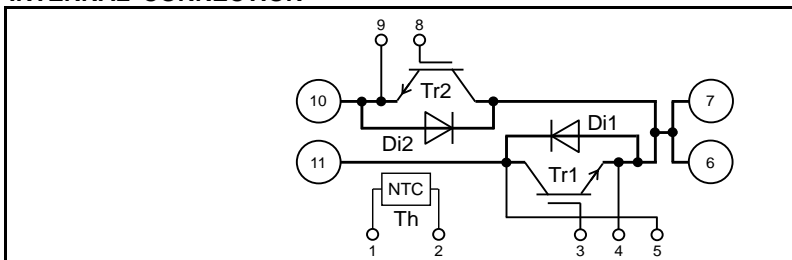

## TERMINAL CODE

1. TH1	6. C2E1
2. TH2	7. C2E1
3. G1	8. G2
4. Es1	9. Es2
5. Cs1	10. E2
	11. C1

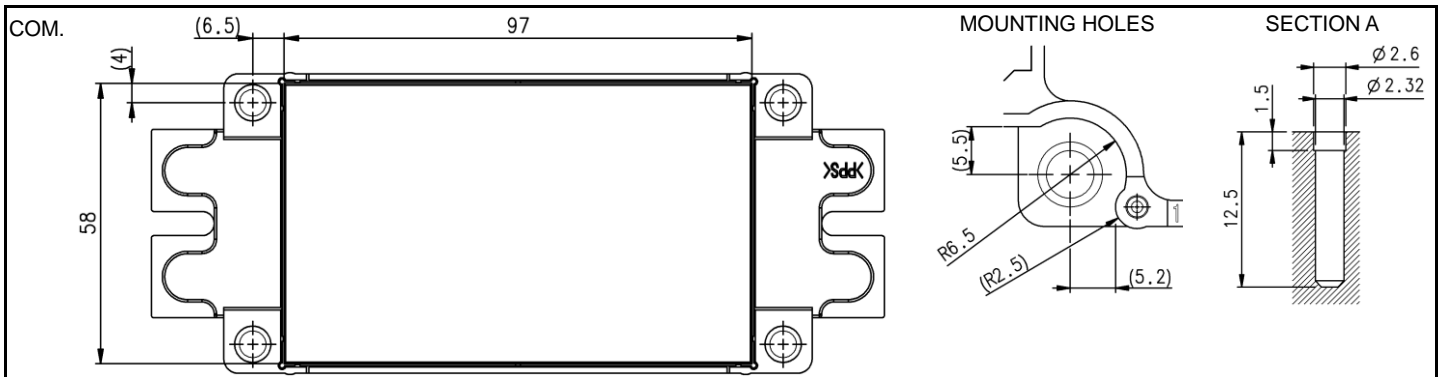

# CM225DX-34T/CM225DXP-34T

HIGH POWER SWITCHING USE

INSULATED TYPE

## OUTLINE DRAWING

Dimension in mm

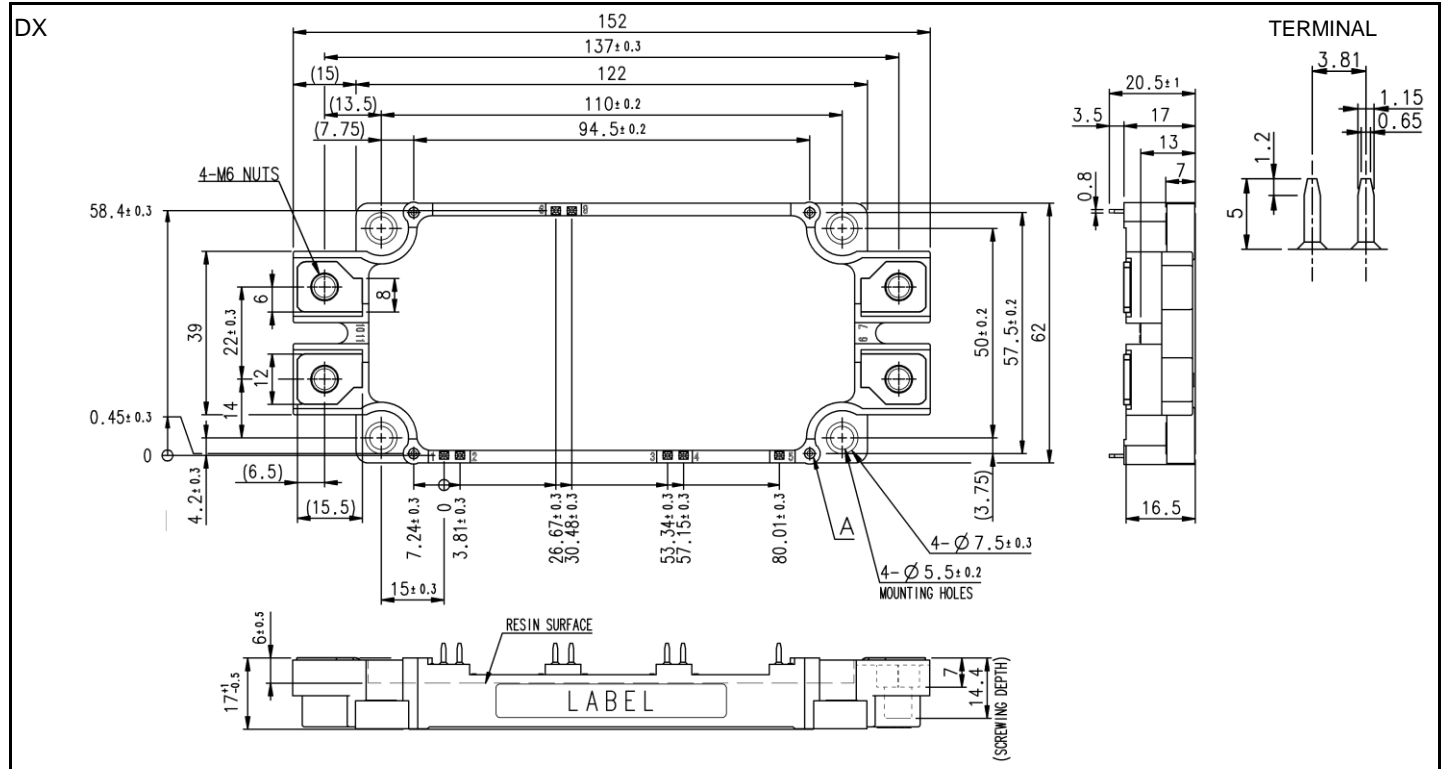

Tolerance otherwise specified

Division of Dimension	Tolerance
0.5 to 3	±0.2
over 3 to 6	±0.3
over 6 to 30	±0.5
over 30 to 120	±0.8
over 120 to 400	±1.2

# CM225DX-34T/CM225DXP-34T

HIGH POWER SWITCHING USE  
INSULATED TYPE

## OUTLINE DRAWING

Dimension in mm

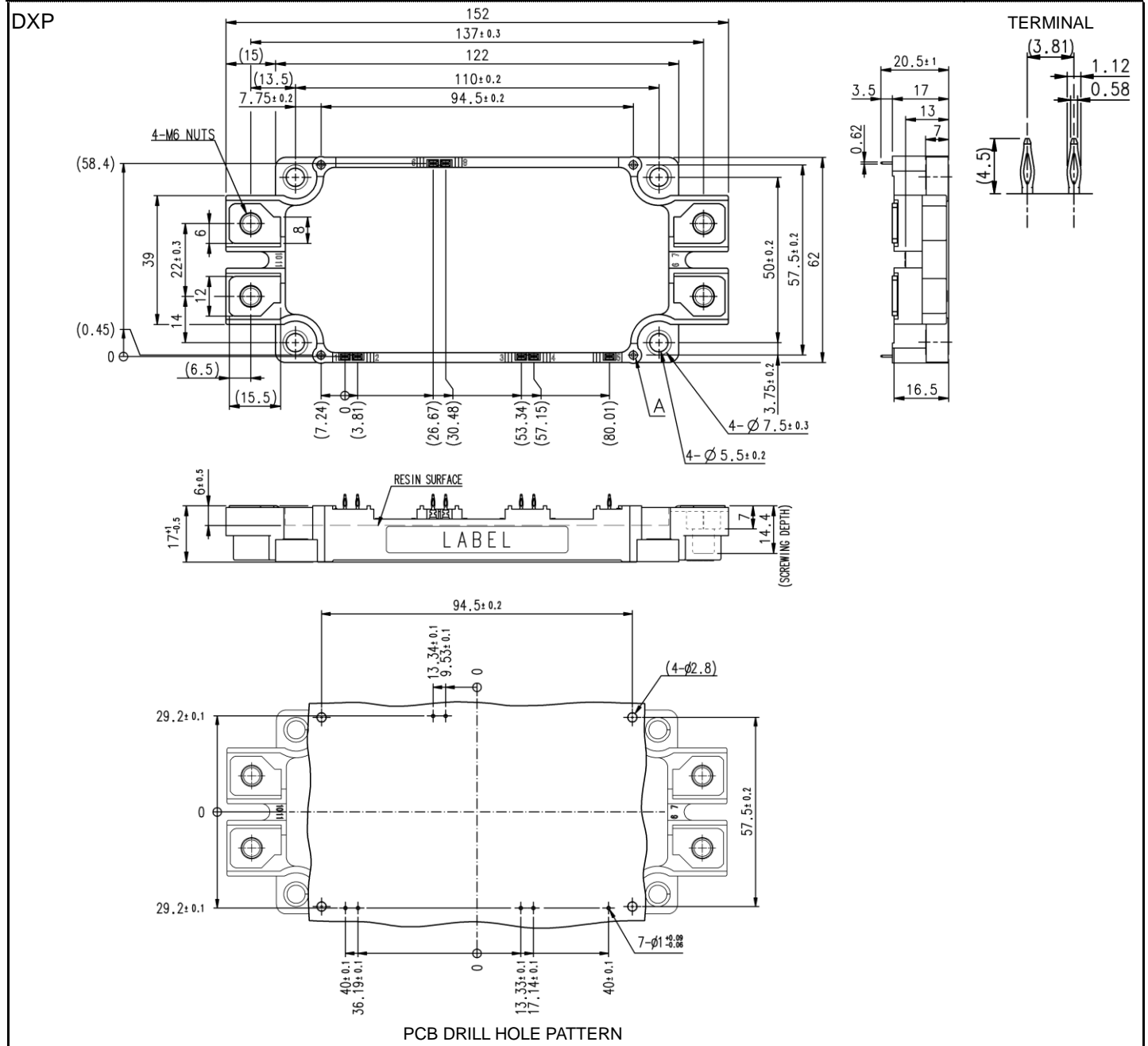

Tolerance otherwise specified

Division of Dimension	Tolerance
0.5 to 3	±0.2
over 3 to 6	±0.3
over 6 to 30	±0.5
over 30 to 120	±0.8
over 120 to 400	±1.2

# CM225DX-34T/CM225DXP-34T

HIGH POWER SWITCHING USE  
INSULATED TYPE

## MAXIMUM RATINGS ( $T_{vj}=25\text{ }^{\circ}\text{C}$ , unless otherwise specified)

### INVERTER PART IGBT/FWD

Symbol	Item	Conditions	Rating	Unit
$V_{CES}$	Collector-emitter voltage	G-E short-circuited	1700	V
$V_{GES}$	Gate-emitter voltage	C-E short-circuited	$\pm 20$	V
$I_C$	Collector current	DC, $T_C=104\text{ }^{\circ}\text{C}$ (Note2, 4)	225	A
$I_{CRM}$		Pulse, Repetitive (Note3)	450	
$P_{tot}$	Total power dissipation	$T_C=25\text{ }^{\circ}\text{C}$ (Note2, 4)	1440	W
$I_E$ (Note1)	Emitter current	DC (Note2)	225	A
$I_{ERM}$ (Note1)		Pulse, Repetitive (Note3)	450	

### MODULE

Symbol	Item	Conditions	Rating	Unit
$V_{isol}$	Isolation voltage	Terminals to base plate, RMS, f=60 Hz, AC 1 min	4000	V
$T_{vjmax}$	Maximum junction temperature	Instantaneous event (overload)	175	$^{\circ}\text{C}$
$T_{Cmax}$	Maximum case temperature	(Note4)	125	
$T_{vjop}$	Operating junction temperature	Continuous operation (under switching)	-40 ~ +150	$^{\circ}\text{C}$
$T_{stg}$	Storage temperature	-	-40 ~ +125	

## ELECTRICAL CHARACTERISTICS ( $T_{vj}=25\text{ }^{\circ}\text{C}$ , unless otherwise specified)

### INVERTER PART IGBT/FWD

Symbol	Item	Conditions	Limits			Unit	
			Min.	Typ.	Max.		
$I_{CES}$	Collector-emitter cut-off current	$V_{CE}=V_{CES}$ , G-E short-circuited	-	-	1.0	mA	
$I_{GES}$	Gate-emitter leakage current	$V_{GE}=V_{GES}$ , C-E short-circuited	-	-	0.5	$\mu\text{A}$	
$V_{GE(th)}$	Gate-emitter threshold voltage	$I_C=22.5\text{ mA}$ , $V_{CE}=10\text{ V}$	5.4	6.0	6.6	V	
$V_{CEsat}$ (Terminal)	Collector-emitter saturation voltage	$I_C=225\text{ A}$ , $V_{GE}=15\text{ V}$ , Refer to the figure of test circuit (Note5)	$T_{vj}=25\text{ }^{\circ}\text{C}$	-	2.00	2.40	V
			$T_{vj}=125\text{ }^{\circ}\text{C}$	-	2.40	-	
			$T_{vj}=150\text{ }^{\circ}\text{C}$	-	2.50	-	
$V_{CEsat}$ (Chip)		$I_C=225\text{ A}$ , $V_{GE}=15\text{ V}$ , (Note5)	$T_{vj}=25\text{ }^{\circ}\text{C}$	-	1.95	2.35	V
			$T_{vj}=125\text{ }^{\circ}\text{C}$	-	2.35	-	
			$T_{vj}=150\text{ }^{\circ}\text{C}$	-	2.45	-	
$C_{ies}$	Input capacitance	$V_{CE}=10\text{ V}$ , G-E short-circuited	-	-	60	nF	
$C_{oes}$	Output capacitance		-	-	1.6		
$C_{res}$	Reverse transfer capacitance		-	-	0.5		
$Q_G$	Gate charge	$V_{CC}=1000\text{ V}$ , $I_C=225\text{ A}$ , $V_{GE}=15\text{ V}$	-	1.76	-	$\mu\text{C}$	
$t_{d(on)}$	Turn-on delay time	$V_{CC}=1000\text{ V}$ , $I_C=225\text{ A}$ , $V_{GE}=\pm 15\text{ V}$ , $R_G=0\text{ }\Omega$ , Inductive load	-	-	800	ns	
$t_r$	Rise time		-	-	200		
$t_{d(off)}$	Turn-off delay time		-	-	800		
$t_f$	Fall time		-	-	600		
$V_{EC}$ (Terminal) (Note1)	Emitter-collector voltage	$I_E=225\text{ A}$ , G-E short-circuited, Refer to the figure of test circuit (Note5)	$T_{vj}=25\text{ }^{\circ}\text{C}$	-	2.70	3.30	V
			$T_{vj}=125\text{ }^{\circ}\text{C}$	-	2.90	-	
			$T_{vj}=150\text{ }^{\circ}\text{C}$	-	2.90	-	
$V_{EC}$ (Chip) (Note1)		$I_E=225\text{ A}$ , G-E short-circuited, (Note5)	$T_{vj}=25\text{ }^{\circ}\text{C}$	-	2.65	3.25	V
			$T_{vj}=125\text{ }^{\circ}\text{C}$	-	2.75	-	
			$T_{vj}=150\text{ }^{\circ}\text{C}$	-	2.75	-	
$t_{rr}$ (Note1)	Reverse recovery time	$V_{CC}=1000\text{ V}$ , $I_E=225\text{ A}$ , $V_{GE}=\pm 15\text{ V}$ ,	-	-	300	ns	
$Q_{rr}$ (Note1)	Reverse recovery charge	$R_G=0\text{ }\Omega$ , Inductive load	-	10.2	-	$\mu\text{C}$	
$E_{on}$	Turn-on switching energy per pulse	$V_{CC}=1000\text{ V}$ , $I_C=I_E=225\text{ A}$ ,	-	51.5	-	mJ	
$E_{off}$	Turn-off switching energy per pulse	$V_{GE}=\pm 15\text{ V}$ , $R_G=0\text{ }\Omega$ , $T_{vj}=150\text{ }^{\circ}\text{C}$ ,	-	56.4	-		
$E_{rr}$ (Note1)	Reverse recovery energy per pulse	Inductive load	-	29.0	-	mJ	
$R_{CC'+EE'}$	Internal lead resistance	Main terminals-chip, per switch, $T_C=25\text{ }^{\circ}\text{C}$ (Note4)	-	0.94	-	m $\Omega$	
$r_g$	Internal gate resistance	Per switch	-	3.3	-	$\Omega$	

# CM225DX-34T/CM225DXP-34T

HIGH POWER SWITCHING USE  
INSULATED TYPE

## ELECTRICAL CHARACTERISTICS (cont.; T<sub>vj</sub>=25 °C, unless otherwise specified) NTC THERMISTOR PART

Symbol	Item	Conditions	Limits			Unit
			Min.	Typ.	Max.	
R <sub>25</sub>	Zero-power resistance	T <sub>C</sub> =25 °C (Note4)	4.85	5.00	5.15	kΩ
ΔR/R	Deviation of resistance	R <sub>100</sub> =493 Ω, T <sub>C</sub> =100 °C (Note4)	-7.3	-	+7.8	%
B <sub>(25/50)</sub>	B-constant	Approximate by equation (Note6)	-	3375	-	K
P <sub>25</sub>	Power dissipation	T <sub>C</sub> =25 °C (Note4)	-	-	10	mW

## THERMAL RESISTANCE CHARACTERISTICS

Symbol	Item	Conditions	Limits			Unit
			Min.	Typ.	Max.	
R <sub>th(j-c)Q</sub>	Thermal resistance	Junction to case, per Inverter IGBT (Note4)	-	-	104	K/kW
R <sub>th(j-c)D</sub>		Junction to case, per Inverter FWD (Note4)	-	-	176	
R <sub>th(c-s)</sub>	Contact thermal resistance	Case to heat sink, Thermal grease applied (Note4, 7) per 1 module, PC-TIM applied (Note4, 8)	-	11.5	-	K/kW
			-	3.1	-	

## MECHANICAL CHARACTERISTICS

Symbol	Item	Conditions	Limits			Unit	
			Min.	Typ.	Max.		
M <sub>t</sub>	Mounting torque	Main terminals M 6 screw	3.5	4.0	4.5	N·m	
M <sub>s</sub>	Mounting torque	Mounting to heat sink M 5 screw	2.5	3.0	3.5	N·m	
d <sub>s</sub>	Creepage distance	Solder pin type (DX)	Terminal to terminal	17	-	-	mm
			Terminal to base plate	18.1	-	-	
		Pressfit pin type (DXP)	Terminal to terminal	17	-	-	mm
			Terminal to base plate	18.6	-	-	
d <sub>a</sub>	Clearance	Solder pin type (DX)	Terminal to terminal	10	-	-	mm
			Terminal to base plate	16.2	-	-	
		Pressfit pin type (DXP)	Terminal to terminal	10	-	-	mm
			Terminal to base plate	16.2	-	-	
e <sub>c</sub>	Flatness of base plate	On the centerline X, Y (Note9)	±0	-	+200	μm	
m	mass	-	-	300	-	g	

\*: This product is compliant with the Restriction of the Use of Certain Hazardous Substances in Electrical and Electronic Equipment (RoHS) directive 2011/65/EU.

Note1. Represent ratings and characteristics of the anti-parallel, emitter-collector free-wheeling diode (FWD).

- Junction temperature (T<sub>vj</sub>) should not increase beyond T<sub>vjmax</sub> rating.
- Pulse width and repetition rate should be such that the device junction temperature (T<sub>vj</sub>) dose not exceed T<sub>vjmax</sub> rating.
- Case temperature (T<sub>C</sub>) and heat sink temperature (T<sub>S</sub>) are defined on the each surface (mounting side) of base plate and heat sink just under the chips.  
Refer to the figure of chip location.
- Pulse width and repetition rate should be such as to cause negligible temperature rise. Refer to the figure of test circuit.

$$6. B_{(25/50)} = \ln\left(\frac{R_{25}}{R_{50}}\right) / \left(\frac{1}{T_{25}} - \frac{1}{T_{50}}\right)$$

R<sub>25</sub>: resistance at absolute temperature T<sub>25</sub> [K]; T<sub>25</sub>=25 [°C]+273.15=298.15 [K]

R<sub>50</sub>: resistance at absolute temperature T<sub>50</sub> [K]; T<sub>50</sub>=50 [°C]+273.15=323.15 [K]

- Typical value is measured by using thermally conductive grease of λ=0.9 W/(m·K)/D<sub>(c-s)</sub>=50 μm.
- Typical value is measured by using PC-TIM of λ=3.4 W/(m·K)/D<sub>(c-s)</sub>=50 μm.
- The base plate (mounting side) flatness measurement points (X, Y) are shown in the following figure.

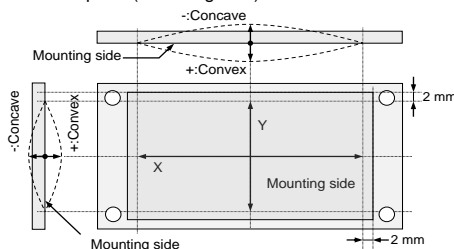

**CM225DX-34T/CM225DXP-34T**

HIGH POWER SWITCHING USE

INSULATED TYPE

Note10. Use the following screws when mounting the printed circuit board (PCB) on the standoffs.

PCB thickness : t1.6

Type	Manufacturer	Size	Tightening torque (N·m)	Recommended tightening method
(1) PT®	EJOT	K25×8	0.55 ± 0.055	by handwork (equivalent to 30 rpm by mechanical screw driver) ~ 600 rpm (by mechanical screw driver)
(2) PT®		K25×10	0.75 ± 0.075 N·m	
(3) DELTA PT®		25×8	0.55 ± 0.055 N·m	
(4) DELTA PT®		25×10	0.75 ± 0.075 N·m	
(5) B1 tapping screw	-	φ2.6×10 φ2.6×12	0.75 ± 0.075 N·m	

**RECOMMENDED OPERATING CONDITIONS**

Symbol	Item	Conditions	Limits			Unit
			Min.	Typ.	Max.	
$V_{CC}$	(DC) Supply voltage	Applied across C1-E2 terminals	-	1000	1200	V
$V_{GEon}$	Gate (-emitter drive) voltage	Applied across G1-Es1/G2-Es2 terminals	13.5	15.0	16.5	V
$R_G$	External gate resistance	Per switch	0	-	30	Ω

# CM225DX-34T/CM225DXP-34T

HIGH POWER SWITCHING USE  
INSULATED TYPE

## CHIP LOCATION (Top view)

Dimension in mm, tolerance: ±1 mm

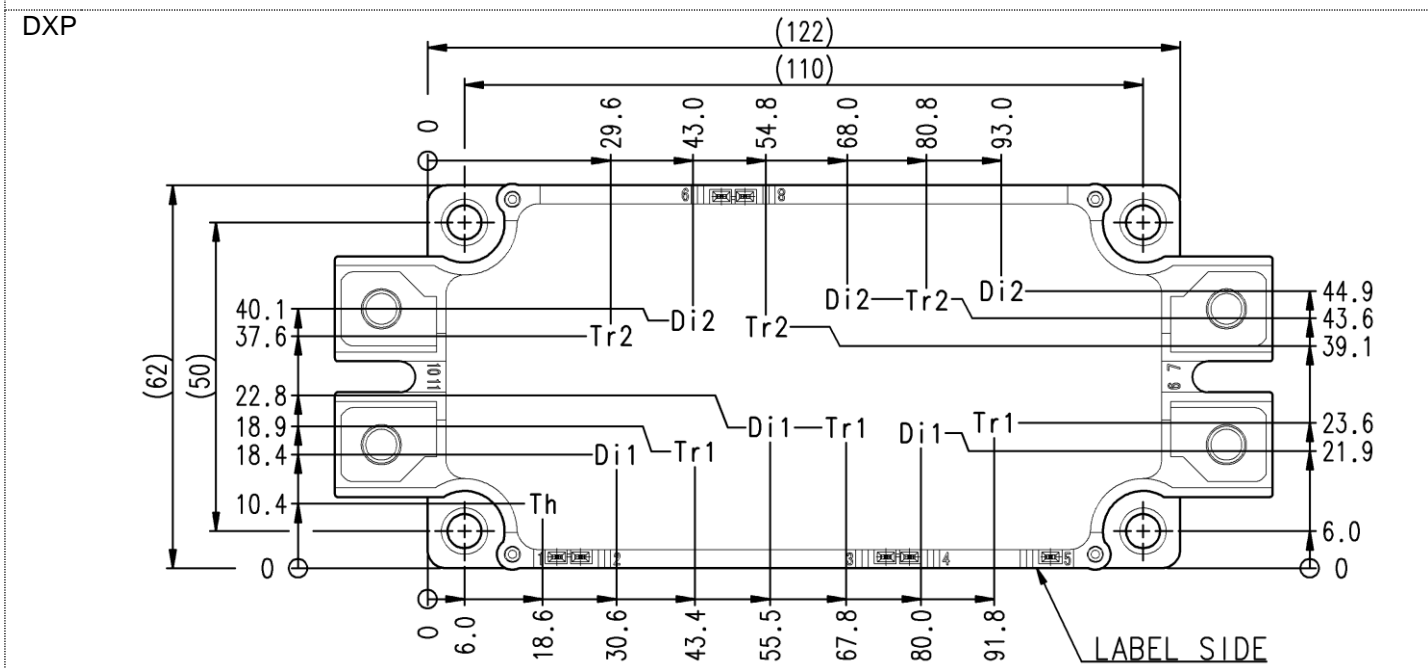
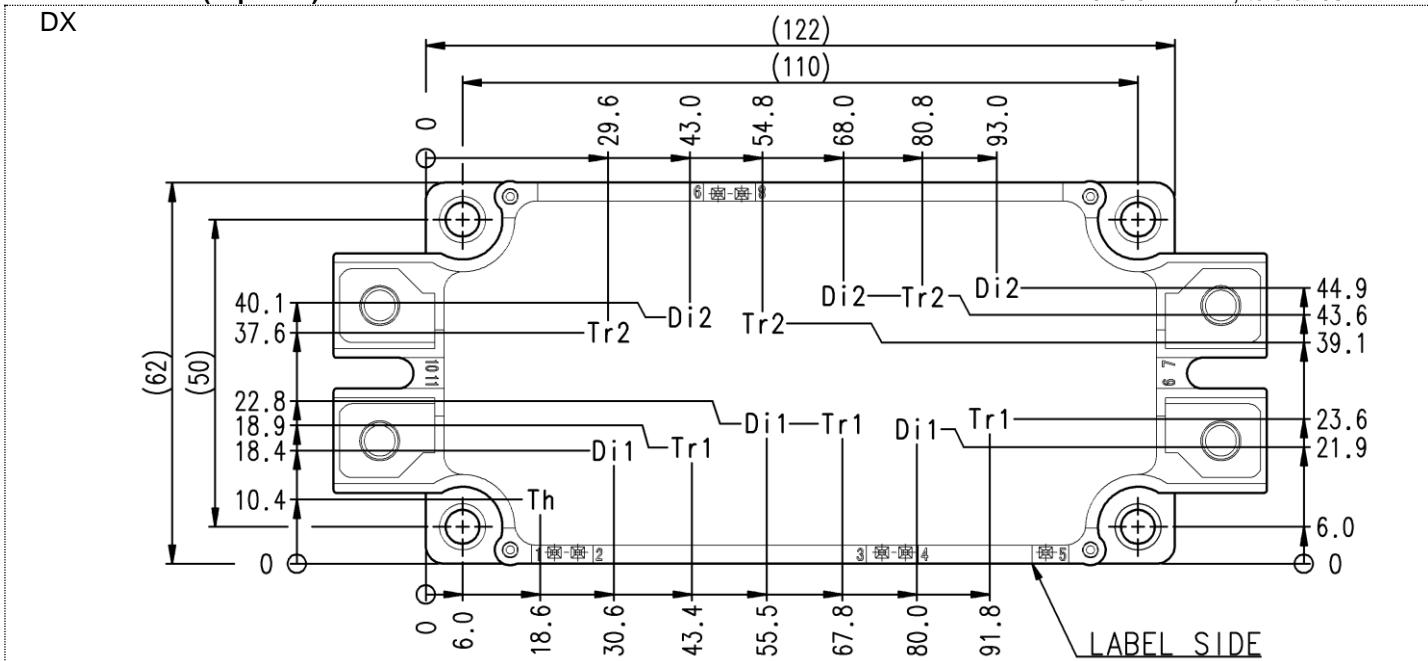

Tr1/Tr2: IGBT, Di1/Di2: FWD, Th: NTC thermistor

### Option: PC-TIM applied baseplate outline

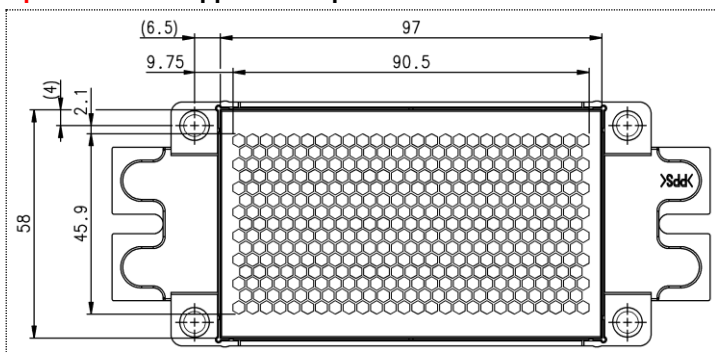

# CM225DX-34T/CM225DXP-34T

HIGH POWER SWITCHING USE  
INSULATED TYPE

## TEST CIRCUIT AND WAVEFORMS

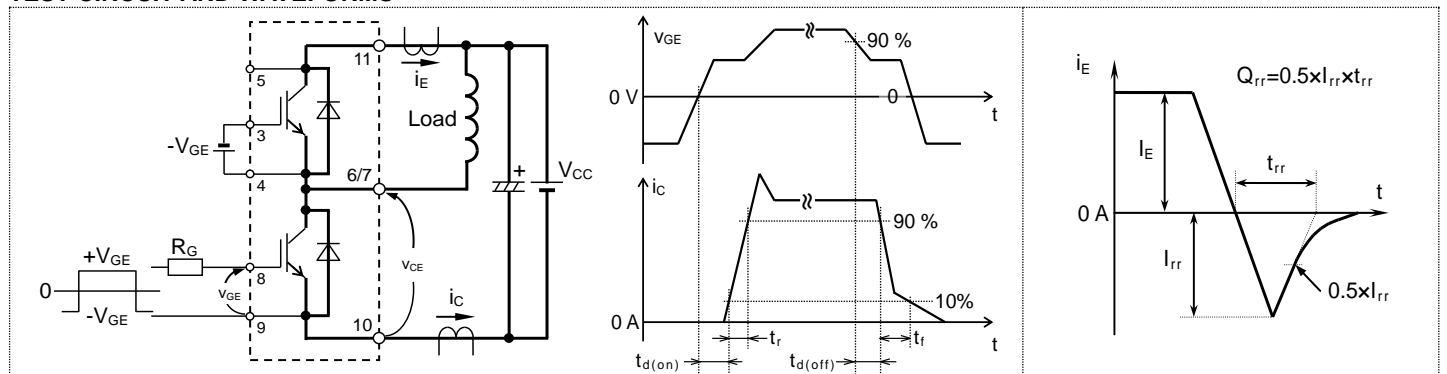

Switching characteristics test circuit and waveforms

$t_{rr}$ ,  $Q_{rr}$  characteristics test waveform

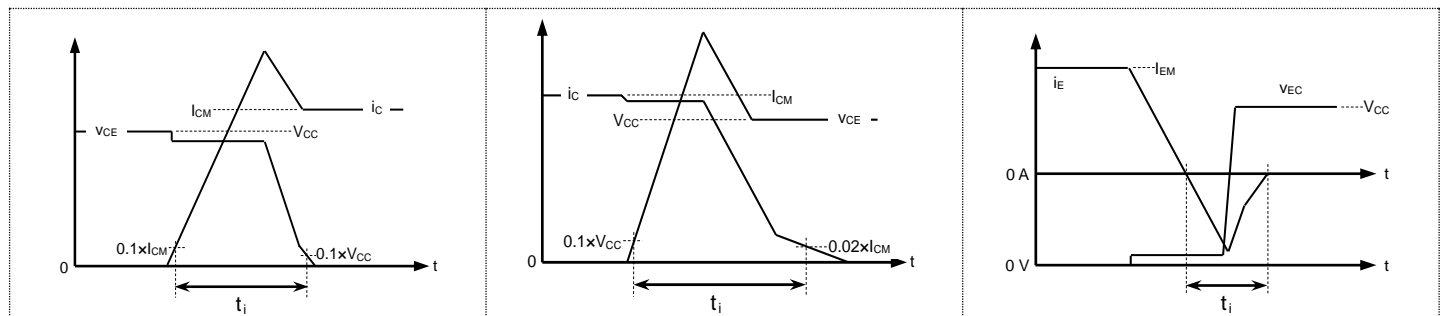

IGBT Turn-on switching energy

IGBT Turn-off switching energy

FWD Reverse recovery energy

Switching energy and Reverse recovery energy test waveforms (Integral time instruction drawing)

## TEST CIRCUIT

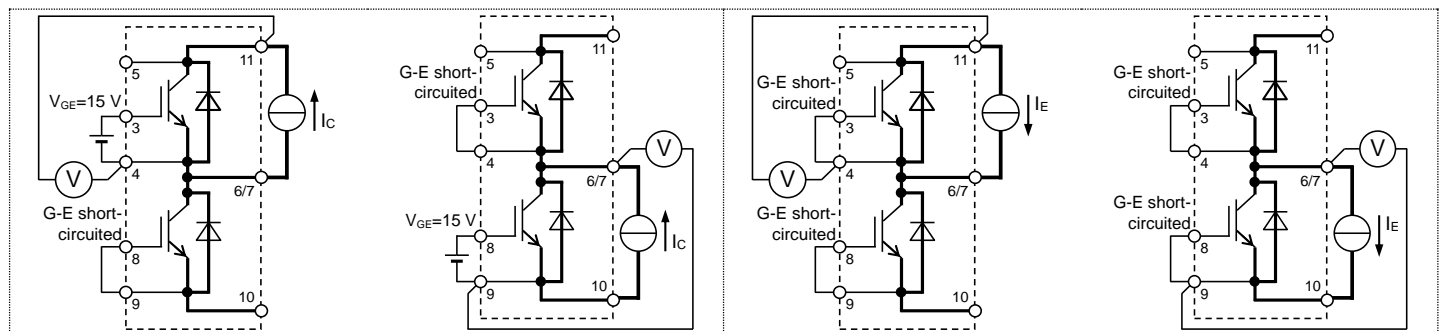

Tr1

Tr2

Di1

Di2

$V_{CEsat}$  characteristics test circuit

$V_{EC}$  characteristics test circuit



**PERFORMANCE CURVES**

**INVERTER PART**

**OUTPUT CHARACTERISTICS (TYPICAL)**

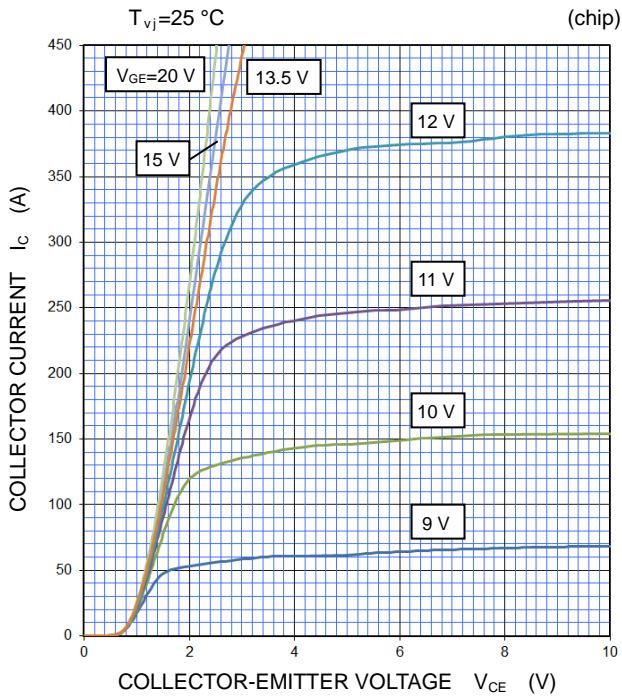

**COLLECTOR-EMITTER SATURATION VOLTAGE CHARACTERISTICS (TYPICAL)**

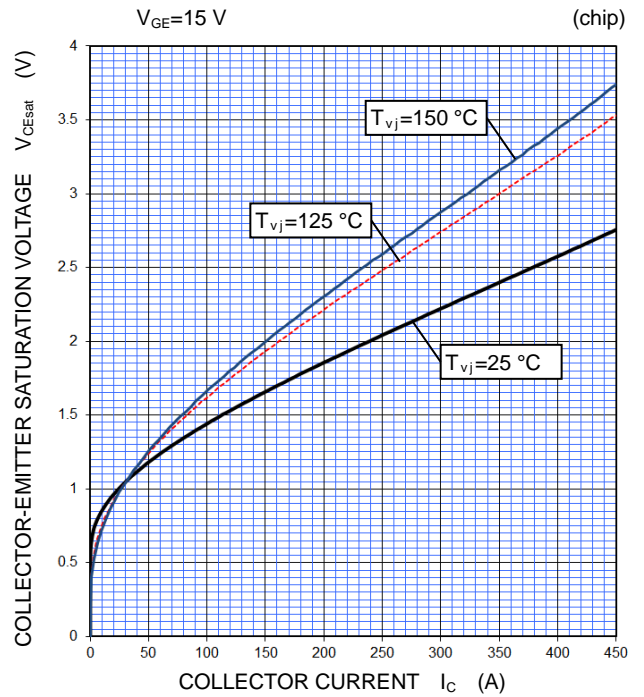

**COLLECTOR-EMITTER VOLTAGE CHARACTERISTICS (TYPICAL)**

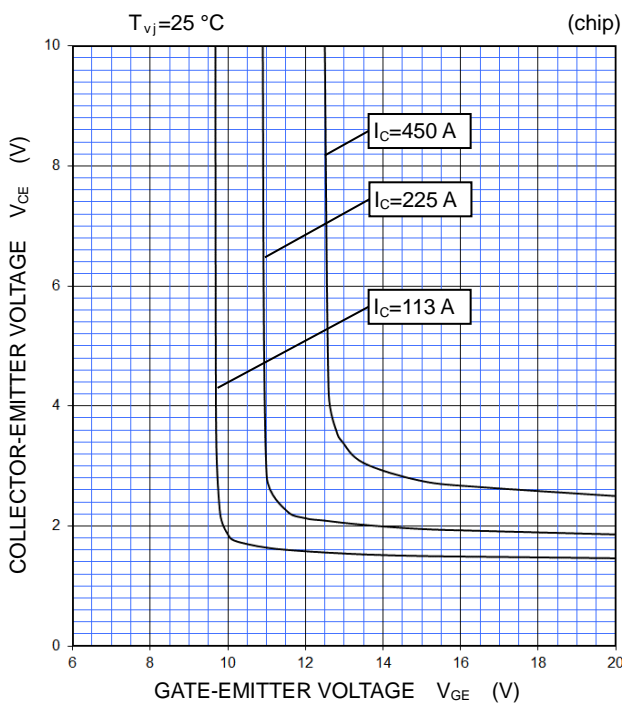

**FREE WHEELING DIODE FORWARD CHARACTERISTICS (TYPICAL)**

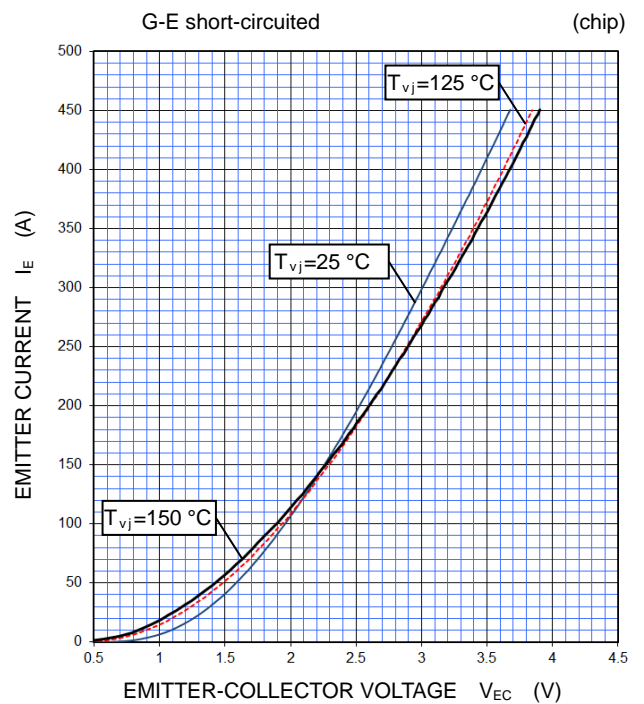

# CM225DX-34T/CM225DXP-34T

HIGH POWER SWITCHING USE  
INSULATED TYPE

## PERFORMANCE CURVES

### INVERTER PART

**HALF-BRIDGE SWITCHING CHARACTERISTICS (TYPICAL)**

$V_{CC}=1000\text{ V}$ ,  $R_G=0\ \Omega$ ,  $V_{GE}=\pm 15\text{ V}$ , INDUCTIVE LOAD  
 —:  $T_{vj}=150\text{ }^\circ\text{C}$ , - - - -:  $T_{vj}=125\text{ }^\circ\text{C}$

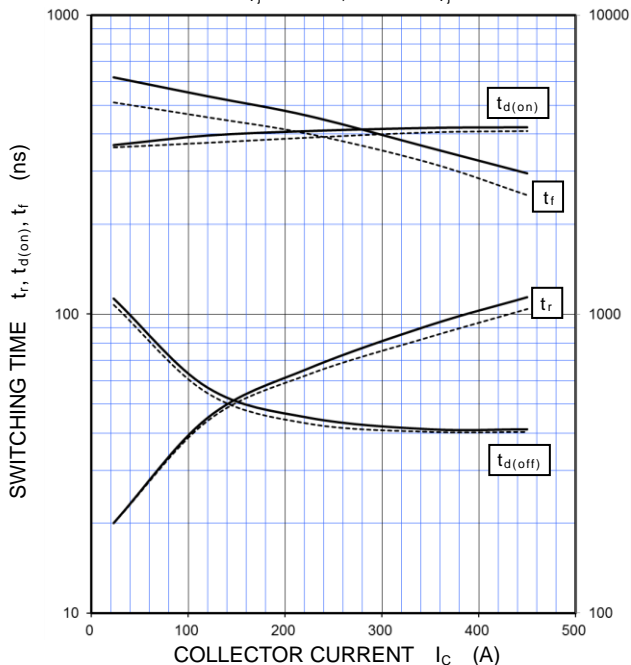

**HALF-BRIDGE SWITCHING CHARACTERISTICS (TYPICAL)**

$V_{CC}=1000\text{ V}$ ,  $I_C=225\text{ A}$ ,  $V_{GE}=\pm 15\text{ V}$ , INDUCTIVE LOAD  
 —:  $T_{vj}=150\text{ }^\circ\text{C}$ , - - - -:  $T_{vj}=125\text{ }^\circ\text{C}$

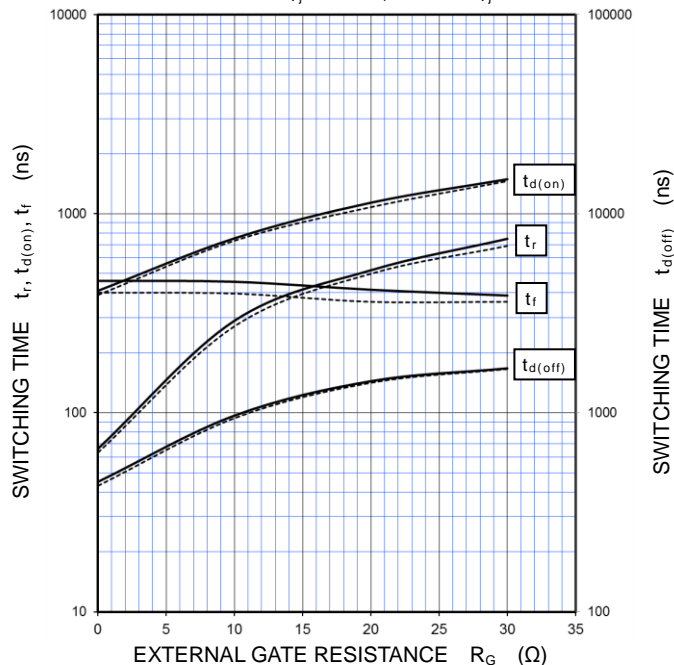

**HALF-BRIDGE SWITCHING CHARACTERISTICS (TYPICAL)**

$V_{CC}=1000\text{ V}$ ,  $R_G=0\ \Omega$ ,  $V_{GE}=\pm 15\text{ V}$ , INDUCTIVE LOAD, PER PULSE  
 —:  $T_{vj}=150\text{ }^\circ\text{C}$ , - - - -:  $T_{vj}=125\text{ }^\circ\text{C}$

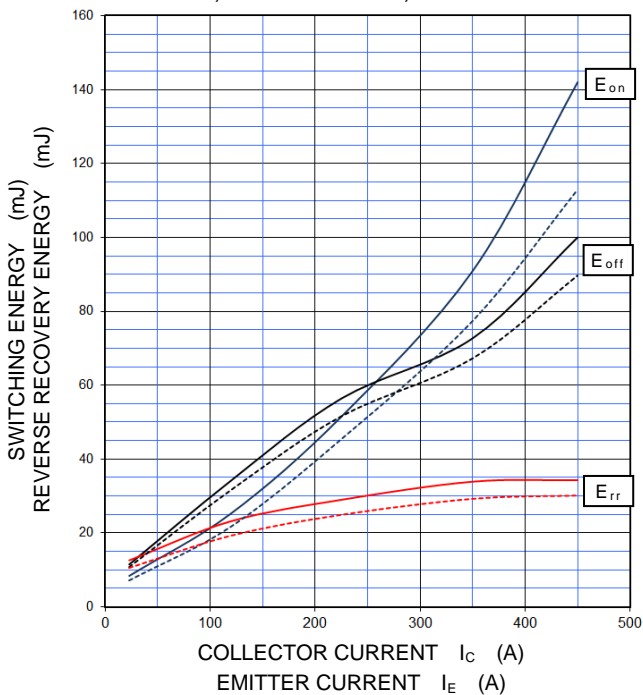

**HALF-BRIDGE SWITCHING CHARACTERISTICS (TYPICAL)**

$V_{CC}=1000\text{ V}$ ,  $I_C/I_E=225\text{ A}$ ,  $V_{GE}=\pm 15\text{ V}$ , INDUCTIVE LOAD, PER PULSE  
 —:  $T_{vj}=150\text{ }^\circ\text{C}$ , - - - -:  $T_{vj}=125\text{ }^\circ\text{C}$

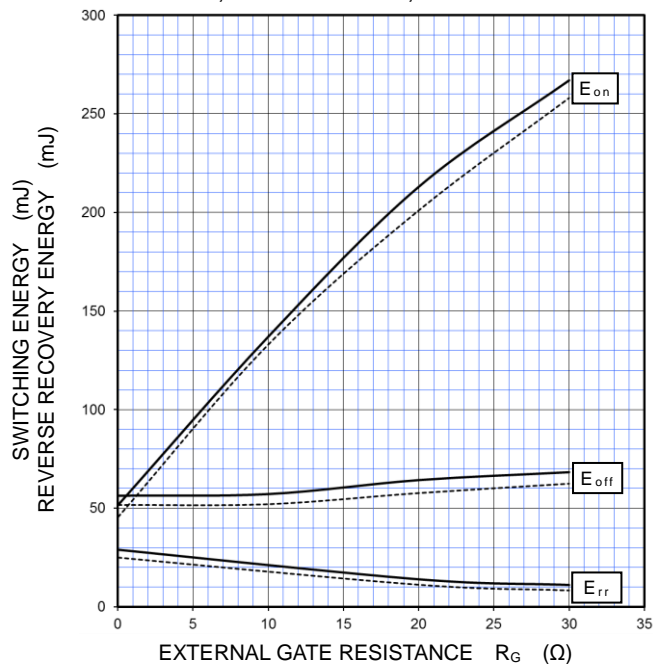

# CM225DX-34T/CM225DXP-34T

HIGH POWER SWITCHING USE  
INSULATED TYPE

## PERFORMANCE CURVES

### INVERTER PART

**CAPACITANCE CHARACTERISTICS (TYPICAL)**

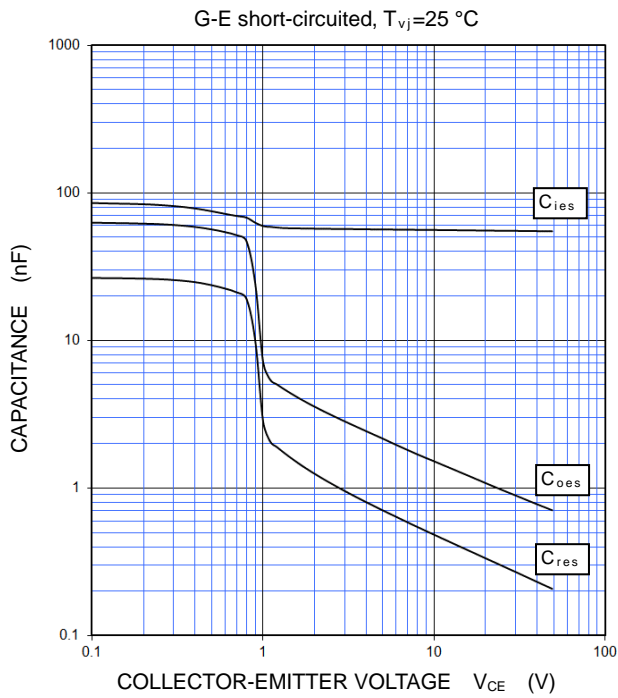

**FREE WHEELING DIODE REVERSE RECOVERY CHARACTERISTICS (TYPICAL)**

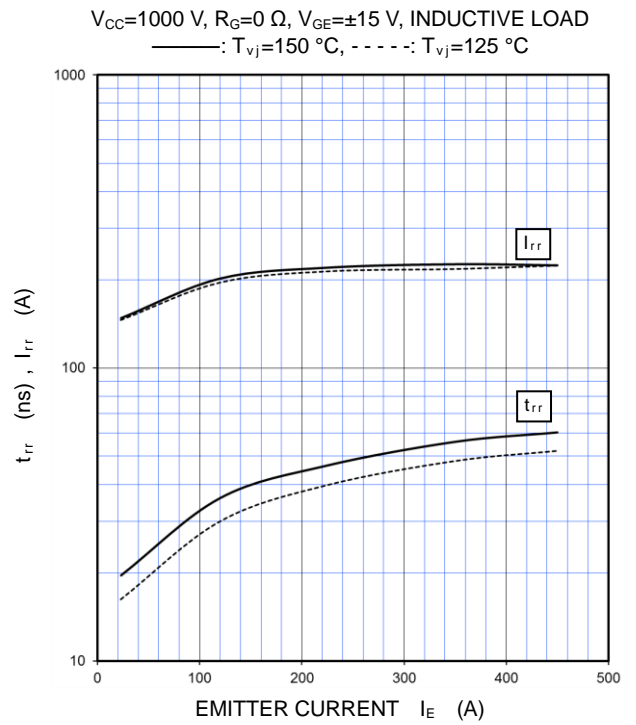

**GATE CHARGE CHARACTERISTICS (TYPICAL)**

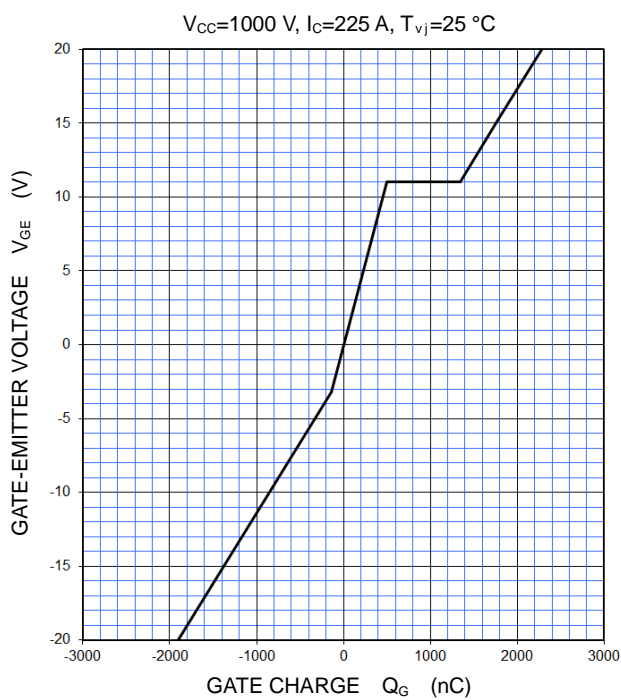

**TRANSIENT THERMAL IMPEDANCE CHARACTERISTICS (MAXIMUM)**

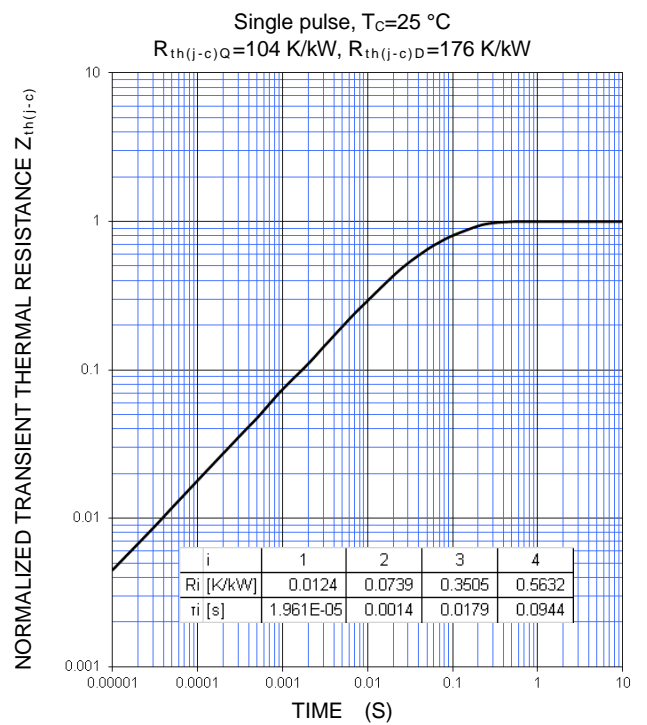

# CM225DX-34T/CM225DXP-34T

HIGH POWER SWITCHING USE  
INSULATED TYPE

## PERFORMANCE CURVES

### INVERTER PART

**TURN-OFF SWITCHING SAFE OPERATING AREA  
(REVERSE BIAS SAFE OPERATING AREA)  
(MAXIMUM)**

$V_{CC} \leq 1200 \text{ V}$ ,  $R_G = 0 \sim 30 \ \Omega$ ,  $V_{GE} = \pm 15 \text{ V}$ ,  
 ———:  $T_{vj} = 25 \sim 150 \text{ }^\circ\text{C}$  (Normal load operations (Continuous))  
 - - - - -:  $T_{vj} = 175 \text{ }^\circ\text{C}$  (Unusual load operations (Limited period))

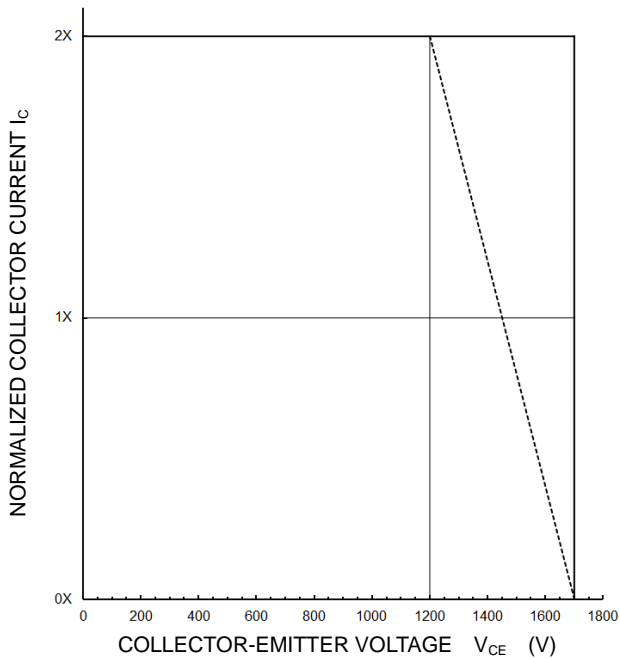

**SHORT-CIRCUIT SAFE OPERATING AREA  
(MAXIMUM)**

$V_{CC} \leq 1200 \text{ V}$ ,  $R_G = 0 \sim 30 \ \Omega$ ,  $V_{GE} = \pm 15 \text{ V}$ ,  
 $T_{vj} = 25 \sim 150 \text{ }^\circ\text{C}$ ,  $t_w \leq 8 \ \mu\text{s}$ , Non-Repetitive

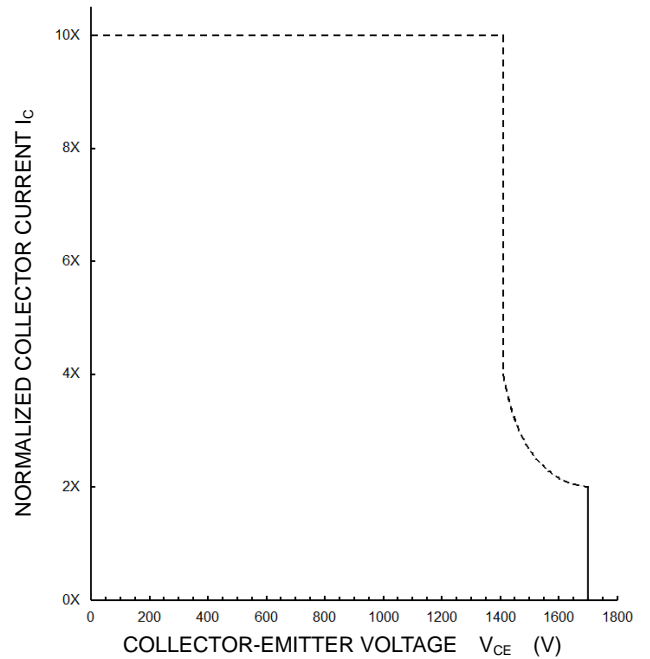

### NTC thermistor part

**TEMPERATURE CHARACTERISTICS  
(TYPICAL)**

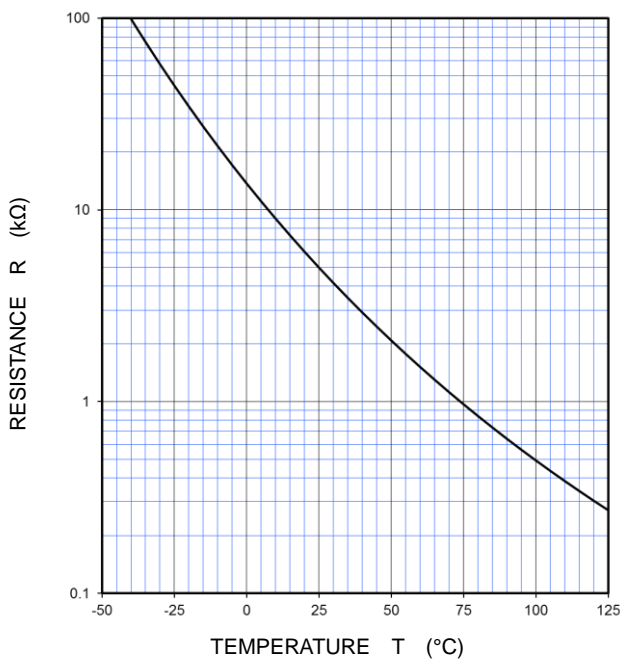

Note: The characteristics curves are presented for reference only and not guaranteed by production test, unless otherwise noted.

## **Keep safety first in your circuit designs!**

This product is designed for industrial application purpose. The performance, the quality and support level of the product is guaranteed by "Customer's Std. Spec."

Mitsubishi Electric Corporation puts its reasonable effort into making semiconductor products better and more reliable, but there is always the possibility that trouble may occur with them by the reliability lifetime such as Power Cycle, Thermal Cycle or others, or to be used under special circumstances (e.g. high humidity, dusty, salty, highlands, environment with lots of organic matter / corrosive gas / explosive gas, or situation which terminal of semiconductor products is received strong mechanical stress).

In the customer's research and development, please evaluate it not only with a single semiconductor product but also in the entire system, and judge whether it's applicable. Furthermore, trouble with semiconductors may lead to personal injury, fire or property damage. Remember to give due consideration to safety when making your circuit designs, with appropriate measures such as (i) placement of substitutive, auxiliary circuits (e.g. appropriate fuse or circuit breaker between a power supply and semiconductor products), (ii) use of non-flammable material or (iii) prevention against any malfunction or mishap.

## **Notes regarding these materials**

- These materials are intended as a reference to assist our customers in the selection of the Mitsubishi semiconductor product best suited to the customer's application; they do not convey any license under any intellectual property rights, or any other rights, belonging to Mitsubishi Electric Corporation or a third party.
- Mitsubishi Electric Corporation assumes no responsibility for any damage, or infringement of any third-party's rights, originating in the use of any product data, diagrams, charts, or circuit application examples contained in these materials.
- All information contained in these materials, including product data, diagrams and charts represents information on products at the time of publication of these materials, and are subject to change by Mitsubishi Electric Corporation without notice due to product improvements or other reasons. It is therefore recommended that customers contact Mitsubishi Electric Corporation or an authorized Mitsubishi Semiconductor product distributor for the latest product information before purchasing a product listed herein.  
The information described here may contain technical inaccuracies or typographical errors. Mitsubishi Electric Corporation assumes no responsibility for any damage, liability, or other loss rising from these inaccuracies or errors.  
Please also pay attention to information published by Mitsubishi Electric Corporation by various means, including the Mitsubishi Semiconductor home page ([www.MitsubishiElectric.com/semiconductors/](http://www.MitsubishiElectric.com/semiconductors/)).
- When using any or all of the information contained in these materials, including product data, diagrams, and charts, please be sure to evaluate all information as a total system before making a final decision on the applicability of the information and products. Mitsubishi Electric Corporation assumes no responsibility for any damage, liability or other loss resulting from the information contained herein.
- Mitsubishi Electric Corporation semiconductors are not designed or manufactured for use in a device or system that is used under circumstances in which human life is potentially at stake. Therefore, this product should not be used in such applications.  
Please contact Mitsubishi Electric Corporation or an authorized Mitsubishi Semiconductor product distributor when considering the use of a product contained herein for any specific purposes, such as apparatus or systems for transportation, vehicular, medical, aerospace, nuclear, or undersea repeater use.
- In the case of new requirement is available, this material will be revised upon consultation.
- The prior written approval of Mitsubishi Electric Corporation is necessary to reprint or reproduce in whole or in part these materials.
- If these products or technologies are subject to the Japanese export control restrictions, they must be exported under a license from the Japanese government and cannot be imported into a country other than the approved destination.  
Any diversion or re-export contrary to the export control laws and regulations of Japan and/or the country of destination is prohibited.
- Please contact Mitsubishi Electric Corporation or an authorized Mitsubishi Semiconductor product distributor for further details on these materials or the products contained therein.

Generally the listed company name and the brand name are the trademarks or registered trademarks of the respective companies.

© 2017 MITSUBISHI ELECTRIC CORPORATION. ALL RIGHTS RESERVED.