

1SMA10CAT3 Series

400 Watt Peak Power Zener Transient Voltage Suppressors

Bidirectional*

The SMA series is designed to protect voltage sensitive components from high voltage, high energy transients. They have excellent clamping capability, high surge capability, low zener impedance and fast response time. The SMA series is supplied in ON Semiconductor's exclusive, cost-effective, highly reliable Surmetic™ package and is ideally suited for use in communication systems, automotive, numerical controls, process controls, medical equipment, business machines, power supplies and many other industrial/consumer applications.

Features

- Working Peak Reverse Voltage Range – 10 V to 78 V
- Standard Zener Breakdown Voltage Range – 11.7 V to 91.3 V
- Peak Power – 400 Watts @ 1 ms
- ESD Rating of Class 3 (> 16 kV) per Human Body Model
- Response Time is Typically < 1 ns
- Flat Handling Surface for Accurate Placement
- Package Design for Top Slide or Bottom Circuit Board Mounting
- Low Profile Package
- Pb-Free Packages are Available

Mechanical Characteristics:

CASE: Void-free, transfer-molded plastic

FINISH: All external surfaces are corrosion resistant and leads are readily solderable

MAXIMUM CASE TEMPERATURE FOR SOLDERING PURPOSES: 260°C for 10 Seconds

POLARITY: Cathode polarity notch does not indicate polarity

MOUNTING POSITION: Any



ON Semiconductor®

<http://onsemi.com>

**PLASTIC SURFACE MOUNT
ZENER OVERVOLTAGE
TRANSIENT SUPPRESSORS
10–78 V V_R
400 W PEAK POWER**



**SMA
CASE 403B
PLASTIC**

MARKING DIAGRAM



- xxC = Device Code (Refer to page 3)
- A = Assembly Location
- Y = Year
- WW = Work Week
- = Pb-Free Package

ORDERING INFORMATION

Device*	Package	Shipping†
1SMAxxCAT3	SMA	5000/Tape & Reel
1SMAxxCAT3G	SMA (Pb-Free)	5000/Tape & Reel

†For information on tape and reel specifications, including part orientation and tape sizes, please refer to our Tape and Reel Packaging Specifications Brochure, BRD8011/D.

*The "T3" suffix refers to a 13 inch reel.

DEVICE MARKING INFORMATION

See specific marking information in the device marking column of the Electrical Characteristics table on page 3 of this data sheet.

1SMA10CAT3 Series

MAXIMUM RATINGS

Rating	Symbol	Value	Unit
Peak Power Dissipation (Note 1) @ $T_L = 25^\circ\text{C}$, Pulse Width = 1 ms	P_{PK}	400	W
DC Power Dissipation @ $T_L = 75^\circ\text{C}$ Measured Zero Lead Length (Note 2) Derate Above 75°C	P_D	1.5	W
Thermal Resistance from Junction-to-Lead	$R_{\theta JL}$	20	mW/ $^\circ\text{C}$
		50	$^\circ\text{C}/\text{W}$
DC Power Dissipation (Note 3) @ $T_A = 25^\circ\text{C}$ Derate Above 25°C	P_D	0.5	W
Thermal Resistance from Junction-to-Ambient	$R_{\theta JA}$	4.0	mW/ $^\circ\text{C}$
		250	$^\circ\text{C}/\text{W}$
Operating and Storage Temperature Range	T_J, T_{stg}	-65 to +150	$^\circ\text{C}$

Stresses exceeding Maximum Ratings may damage the device. Maximum Ratings are stress ratings only. Functional operation above the Recommended Operating Conditions is not implied. Extended exposure to stresses above the Recommended Operating Conditions may affect device reliability.

- 10 X 1000 μs , non-repetitive.
- 1 in square copper pad, FR-4 board.
- FR-4 board, using ON Semiconductor minimum recommended footprint, as shown in 403B case outline dimensions spec.

ELECTRICAL CHARACTERISTICS

($T_A = 25^\circ\text{C}$ unless otherwise noted)

Symbol	Parameter
I_{PP}	Maximum Reverse Peak Pulse Current
V_C	Clamping Voltage @ I_{PP}
V_{RWM}	Working Peak Reverse Voltage
I_R	Maximum Reverse Leakage Current @ V_{RWM}
V_{BR}	Breakdown Voltage @ I_T
I_T	Test Current

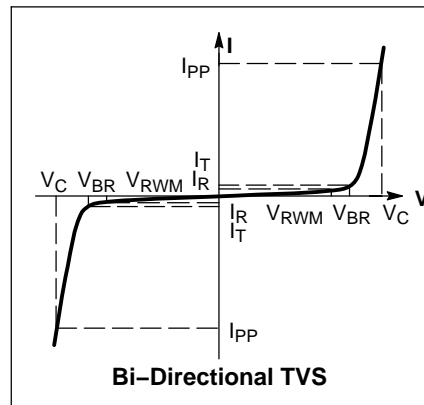

1SMA10CAT3 Series

ELECTRICAL CHARACTERISTICS

Device*	Device Marking	V _{RWM} (Note 4) Volts	I _R @ V _{RWM} μA	Breakdown Voltage				V _C @ I _{PP} (Note 6)		C Typ. (Note 7) pF
				V _{BR} (Volts) (Note 5)			@ I _T	V _C	I _{PP}	
				Min	Nom	Max	mA	Volts	Amps	
1SMA10CAT3, G	QXC	10	2.5	11.1	11.69	12.27	1.0	17.0	23.5	580
1SMA11CAT3, G	QZC	11	2.5	12.2	12.84	13.48	1.0	18.2	22.0	530
1SMA12CAT3, G	REC	12	2.5	13.3	14.00	14.70	1.0	19.9	20.1	490
1SMA13CAT3, G	RGC	13	2.5	14.4	15.16	15.92	1.0	21.5	18.6	455
1SMA14CAT3, G	RKC	14	2.5	15.6	16.42	17.24	1.0	23.2	17.2	425
1SMA15CAT3, G	RMC	15	2.5	16.7	17.58	18.46	1.0	24.4	16.4	400
1SMA16CAT3, G	RPC	16	2.5	17.8	18.74	19.67	1.0	26.0	15.4	375
1SMA18CAT3, G	RTC	18	2.5	20	21.06	22.11	1.0	29.2	13.7	335
1SMA20CAT3, G	RVC	20	2.5	22.2	23.37	24.54	1.0	32.4	12.3	305
1SMA22CAT3, G	RXC	22	2.5	24.4	25.69	26.97	1.0	35.5	11.3	280
1SMA24CAT3, G	RZC	24	2.5	26.7	28.11	29.51	1.0	38.9	10.3	260
1SMA26CAT3, G	SEC	26	2.5	28.9	30.42	31.94	1.0	42.1	9.5	240
1SMA28CAT3, G	SGC	28	2.5	31.1	32.74	34.37	1.0	45.4	8.8	225
1SMA30CAT3, G	SKC	30	1.0	33.3	35.06	36.81	1.0	48.4	8.3	210
1SMA33CAT3, G	SMC	33	2.5	36.7	38.63	40.56	1.0	53.3	7.5	190
1SMA36CAT3, G	SPC	36	2.5	40	42.11	44.21	1.0	58.1	6.9	175
1SMA40CAT3, G	SRC	40	2.5	44.4	46.74	49.07	1.0	64.5	6.2	160
1SMA43CAT3, G	STC	43	2.5	47.8	50.32	52.83	1.0	69.4	5.8	150
1SMA48CAT3, G	SXC	48	2.5	53.3	56.11	58.91	1.0	77.4	5.2	135
1SMA51CAT3, G	SZC	51	2.5	56.7	59.69	62.67	1.0	82.4	4.9	130
1SMA54CAT3, G	TEC	54	2.5	60	63.16	66.32	1.0	87.1	4.6	120
1SMA58CAT3, G	TGC	58	2.5	64.4	67.79	71.18	1.0	93.6	4.3	115
1SMA60CAT3, G	TKC	60	2.5	66.7	70.21	73.72	1.0	96.8	4.1	110
1SMA64CAT3, G	TMC	64	2.5	71.1	74.84	78.58	1.0	103	3.9	105
1SMA70CAT3, G	TPC	70	2.5	77.8	81.90	85.99	1.0	113	3.5	95
1SMA78CAT3, G	TTC	78	2.5	86.7	91.27	95.83	1.0	126	3.2	90

4. A transient suppressor is normally selected according to the working peak reverse voltage (V_{RWM}), which should be equal to or greater than the DC or continuous peak operating voltage level

5. V_{BR} measured at pulse test current I_T at an ambient temperature of 25°C

6. Surge current waveform per Figure 2 and derate per Figure 3

7. Bias voltage = 0 V, F = 1.0 MHz, T_J = 25°C.

†Please see 1SMA5.0AT3 to 1SMA78AT3 for Unidirectional devices.

* The "G" suffix indicates Pb-Free package available.

1SMA10CAT3 Series

RATING AND TYPICAL CHARACTERISTIC CURVES

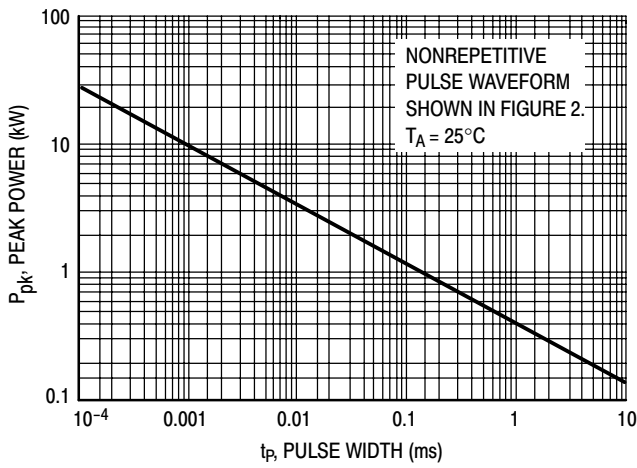

Figure 1. Pulse Rating Curve

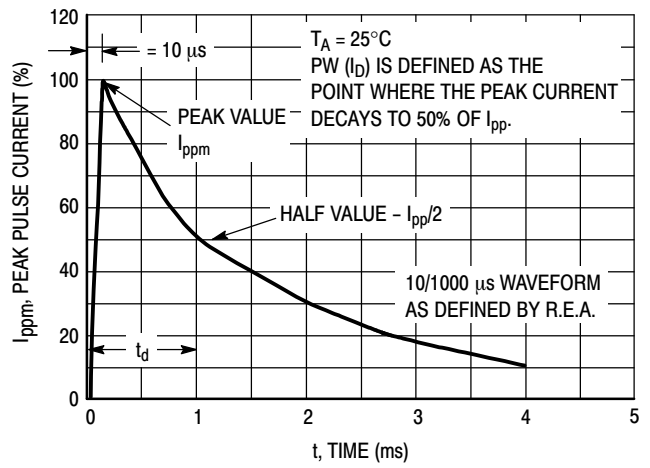

Figure 2. Pulse Waveform

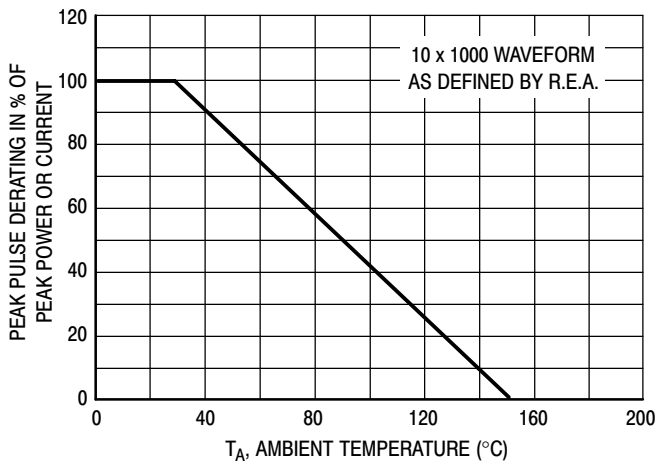

Figure 3. Pulse Derating Curve

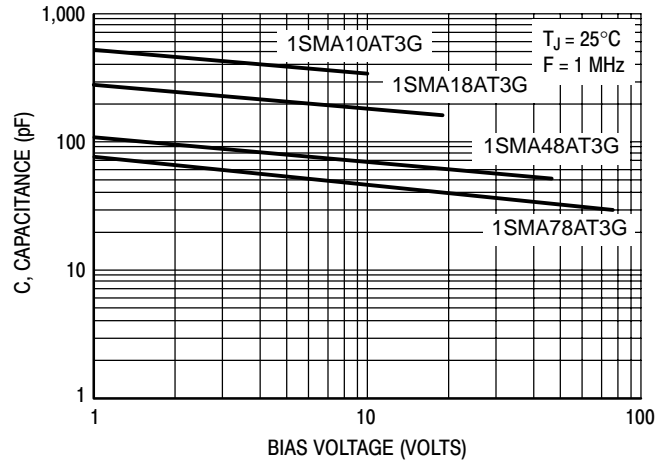
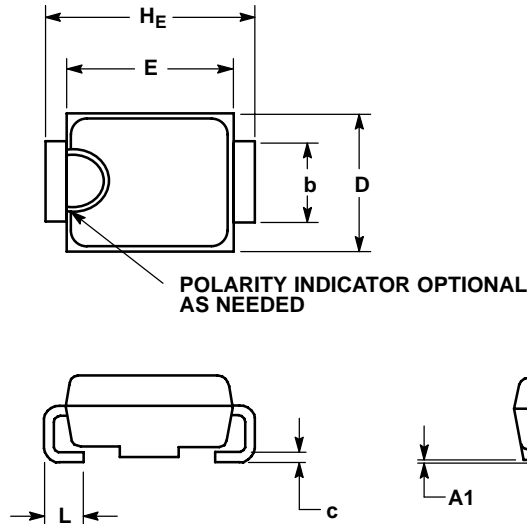

Figure 4. Typical Junction Capacitance vs. Bias Voltage

1SMA10CAT3 Series

PACKAGE DIMENSIONS

SMA
CASE 403B-02
ISSUE D



NOTES:

1. DIMENSIONING AND TOLERANCING PER ANSI Y14.5M, 1982.
2. CONTROLLING DIMENSION: INCH.
3. 403B-01 OBSOLETE, NEW STANDARD 403B-02.

DIM	MILLIMETERS			INCHES		
	MIN	NOM	MAX	MIN	NOM	MAX
A	1.91	2.16	2.41	0.075	0.085	0.095
A1	0.05	0.10	0.15	0.002	0.004	0.006
b	1.27	1.45	1.63	0.050	0.057	0.064
c	0.15	0.28	0.41	0.006	0.011	0.016
D	2.29	2.60	2.92	0.090	0.103	0.115
E	4.06	4.32	4.57	0.160	0.170	0.180
HE	4.83	5.21	5.59	0.190	0.205	0.220
L	0.76	1.14	1.52	0.030	0.045	0.060

SOLDERING FOOTPRINT*

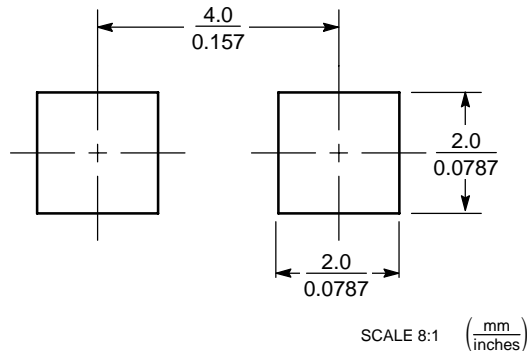

*For additional information on our Pb-Free strategy and soldering details, please download the ON Semiconductor Soldering and Mounting Techniques Reference Manual, SOLDERRM/D.

SURMETIC is a trademark of Semiconductor Components Industries, LLC.

ON Semiconductor and are registered trademarks of Semiconductor Components Industries, LLC (SCILLC). SCILLC reserves the right to make changes without further notice to any products herein. SCILLC makes no warranty, representation or guarantee regarding the suitability of its products for any particular purpose, nor does SCILLC assume any liability arising out of the application or use of any product or circuit, and specifically disclaims any and all liability, including without limitation special, consequential or incidental damages. "Typical" parameters which may be provided in SCILLC data sheets and/or specifications can and do vary in different applications and actual performance may vary over time. All operating parameters, including "Typicals" must be validated for each customer application by customer's technical experts. SCILLC does not convey any license under its patent rights nor the rights of others. SCILLC products are not designed, intended, or authorized for use as components in systems intended for surgical implant into the body, or other applications intended to support or sustain life, or for any other application in which the failure of the SCILLC product could create a situation where personal injury or death may occur. Should Buyer purchase or use SCILLC products for any such unintended or unauthorized application, Buyer shall indemnify and hold SCILLC and its officers, employees, subsidiaries, affiliates, and distributors harmless against all claims, costs, damages, and expenses, and reasonable attorney fees arising out of, directly or indirectly, any claim of personal injury or death associated with such unintended or unauthorized use, even if such claim alleges that SCILLC was negligent regarding the design or manufacture of the part. SCILLC is an Equal Opportunity/Affirmative Action Employer. This literature is subject to all applicable copyright laws and is not for resale in any manner.

PUBLICATION ORDERING INFORMATION

LITERATURE FULFILLMENT:
Literature Distribution Center for ON Semiconductor
P.O. Box 5163, Denver, Colorado 80217 USA
Phone: 303-675-2175 or 800-344-3860 Toll Free USA/Canada
Fax: 303-675-2176 or 800-344-3867 Toll Free USA/Canada
Email: orderlit@onsemi.com

N. American Technical Support: 800-282-9855 Toll Free
USA/Canada
Europe, Middle East and Africa Technical Support:
Phone: 421 33 790 2910
Japan Customer Focus Center
Phone: 81-3-5773-3850

ON Semiconductor Website: www.onsemi.com
Order Literature: <http://www.onsemi.com/orderlit>

For additional information, please contact your local Sales Representative