

9001 Series

DIN41612 Half B Type Female

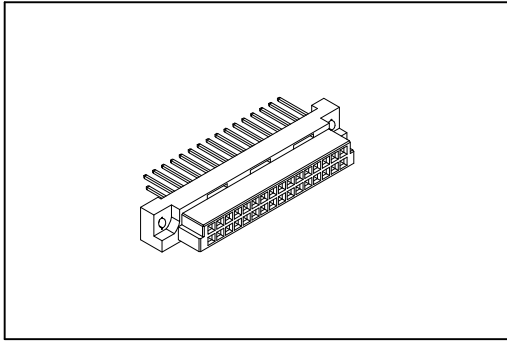

Material:

Housing: Thermoplastic Polyester Glass Filled UL94V-0.
 Contacts: Copper Alloy.

Electrical Characteristics:

Current Rating: 2 A.
 Dielectric Withstanding Voltage: AC 1000V.
 Insulator Resistance: 1000MΩ min.
 Contact Resistance: 20mΩ max.
 Operating Temperature: -55°C ~+125°C.

Features:

- * Mates with Male 2Row Half
 9001-37 Half Q Type.
 9001-35 Half B Type.

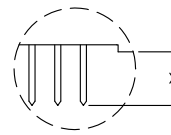
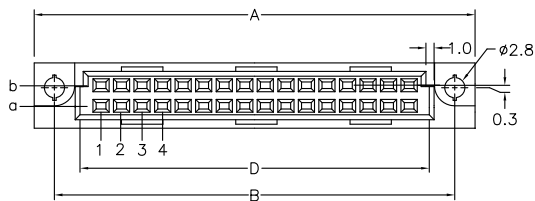

Dip Type

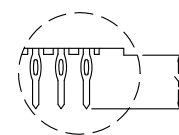

Press Fit Type

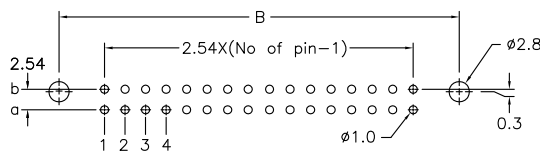
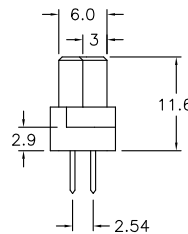
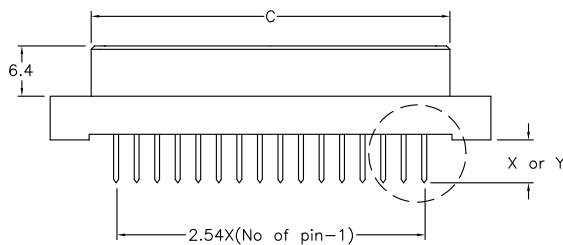

P.C. Board Layout

Length	1	2	W1	W2
X	4.0	2.5	13	17
Y	4.6	6.3	13	17

Dimension				
Position	A	B	C	D
32/16/8	55.00	49.36	44.40	43.50
20/10/5	39.66	34.02	29.10	27.86
Pitch	Position	Rows with Contacts	Contact Arrange	
2.54mm	32	a b		
	20	a b		
	16	a -		
5.08mm	16	a b		
	10	a b		
	8	a -		
5	a -			

Ordering information

9001- 3 6 32 1 C 00 P L1 A
 Series 3: 2.54mm 6: Female Position 1: Dip Length C: Selective Gold 00: G/F P: Blank: Dip L1: With Lock A: Tray
 4: 5.08mm 2: Dip Length Plated 00: G/F P: Press Fit L1: With Lock Package
 W1: Dip Length W2: Dip Length See Page CA03

9001 Series

DIN41612 Mating Introduce

2 Row insulator
 B (Standard mounting)
 Mounting axis
 of the connector

3 Row insulator
 C (Standard mounting)
 Mounting axis
 of the connector

Board lock available
 L1=P.C.B. Thickness 1.6 ~2.0 mm
 L2=P.C.B. Thickness 2.8 ~3.2 mm

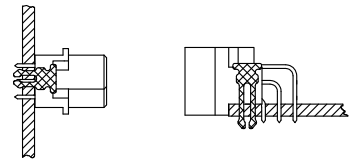
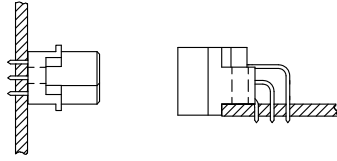
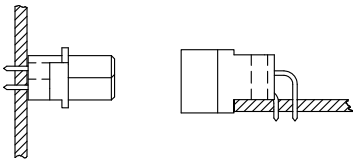

Q (Reverse mounting)
 Mounting axis
 of the connector

R (Reverse mounting)
 Mounting axis
 of the connector

Board lock available
 L1=P.C.B. Thickness 1.6 ~2.0 mm
 L2=P.C.B. Thickness 2.8 ~3.2 mm

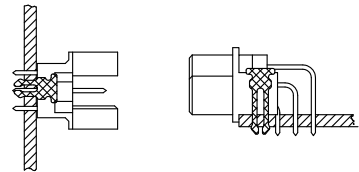
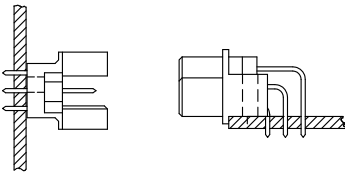
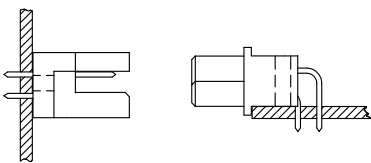

I.D.C. Type Ribbon Cable

Press Fit Type
 2 Row insulator

3 Row insulator

2 Row insulator

3 Row insulator

