



PP3DP
WWW.PP3DP.COM

UP!User Manual

www.pp3dp.com

PP3DP-2012-V3

Legal Notice

The information in this document is subject to change without notice.

DELTA MICRO FACTORY CO. MAKES NO WARRANTY OF ANY KIND WITH REGARD TO THIS MATERIAL, INCLUDING, BUT NOT LIMITED TO, THE IMPLIED WARRANTIES OF MERCHANTABILITY AND FITNESS FOR A PARTICULAR PURPOSE. Delta Micro Factory Co. shall not be liable for errors contained herein or for incidental or consequential damages in connection with the furnishing, performance, or use of this Material. Changes or modifications to the system not expressly approved by Delta Micro Factory Co., the party responsible for compliance, could void the user's authority for use. This document is protected by copyright. All rights reserved. Its use, disclosure, and possession are restricted by an agreement with Delta Micro Factory Co. per software copyright. No part of this document may be photocopied, reproduced or translated into another language without the prior written consent of Delta Micro Factory Co.

© Copyright 2012 Delta Micro Factory Corporation All rights reserved.

1. INTRODUCTION	3
1.1 HOW TO USE THIS MANUAL	3
1.2 PRECAUTIONS	3
1.2.1 Safety	3
1.2.2 Protection	4
2. OVERVIEW	5
2.1 APPEARANCE	5
2.2 SPECIFICATIONS	8
2.2.1 Printer Physical Characteristics	8
2.2.2 Specifications	8
2.2.3 Environmental specifications	8
3. OPERATION	9
3.1 PREPARATION	9
3.1.1 Installing the printer	9
3.1.2 Installing the software	12
3.1.3 Installing drivers	12
3.2 USING THE BASIC FUNCTIONS	14
3.2.1 Start the program	14
3.2.2 Loading a 3D model	14
3.2.3 View Options	17
3.2.4 Model transformations	18
3.2.5 Placing models onto the build platform	20
3.3 GETTING READY TO PRINT	21
3.3.1 Initializing the Printer	21
3.3.2 Calibrating the Nozzle Height	22
3.3.3 Leveling the print platform	26
3.3.4 Other Maintenance Options	27
3.3.5 Preparing the Platform	29
3.3.6 Print Setup Options	30
4. PRINTING	35
5. MODEL REMOVAL	37
REMOVING SUPPORT MATERIAL	38
6. MAINTENANCE	40
CHANGING THE MATERIAL	40
VERTICAL CALIBRATION	40
CLEANING THE NOZZLE	42
REMOVING / CHANGING THE NOZZLE	43
CLEANING THE PLATFORM	44
LUBRICATION OF BEARINGS	44
SPARE PARTS	44
7.0. TIPS & TRICKS	45
8. TROUBLESHOOTING	47
SOLUTION FOR "USB.DLL NOT FOUND" PROBLEM	47

1. Introduction

1.1 How to use this manual

This User Manual is divided into four sections which cover the Introduction, Overview, Operation, and Troubleshooting. Please study this manual carefully before installation, and use the printer according to these instructions. Keep this manual handy and refer to it when necessary.

1.2 Precautions



Please read this section carefully before using the printer.

1.2.1 Safety

- ◆ The printer can only be used with the power adapters supplied by this company, or the product may be damaged, with a risk of fire.
- ◆ To avoid burning, or model deformation, do not touch the model, nozzle, or the platform by hand, or any other part of the body, while the printer is working or immediately after it has finished printing.
- ◆ Protective glasses should always be worn when removing support material, especially PLA.
- ◆ The brown sections of the currently supplied gloves melt at around 200 degrees, therefore please do not hold the extruder block with the gloves.
- ◆ There is a slight smell from ABS when it is being extruded. The smell is, however, not too unpleasant. A well ventilated room is recommended by most people to be safe, however when printing keep the printer away from any draughts as this can affect the warping of ABS prints. When ABS is burnt it releases toxic fumes.

The following classifications are used in this manual.

	CAUTION: Indicates a potentially hazardous situation which, if not avoided, may result in minor or moderate injury.
---	---

	<p>WARNING: Indicates a potentially hazardous situation which, if not avoided, may result in serious injury.</p>
	<p>Gloves: When performing certain maintenance procedures, the machine may be hot and gloves are required to avoid burns.</p>
	<p>Safety Glasses: Wear safety glasses to avoid injury to your eyes.</p>

1.2.2 Protection

- ◆ The printer must not be exposed to water or rain, or damage may occur.
- ◆ Do not shut down the UP! System or pull out the USB cable when loading a digital model, or the model data may be lost.
- ◆ When using the “Extrude” function, keep at least 50mm between the nozzle and the platform. If too close, the nozzle may get blocked.
- ◆ The printer is designed to work properly at an ambient temperature of between 15°C and 30°C and humidity of between 20% and 50%; Operating outside these limits may result in low quality models.

2. Overview

The UP! Printer is designed with ultimate portability and simplicity in mind. The system and software allow you to print great models with only a few keystrokes, even if you have never used a 3D printer before. The system uses a nozzle to deposit molten plastic, so printed parts are strong and durable. Congratulations on purchasing an UP! Printer.

2.1 Appearance

Figure 1. Front view of printer

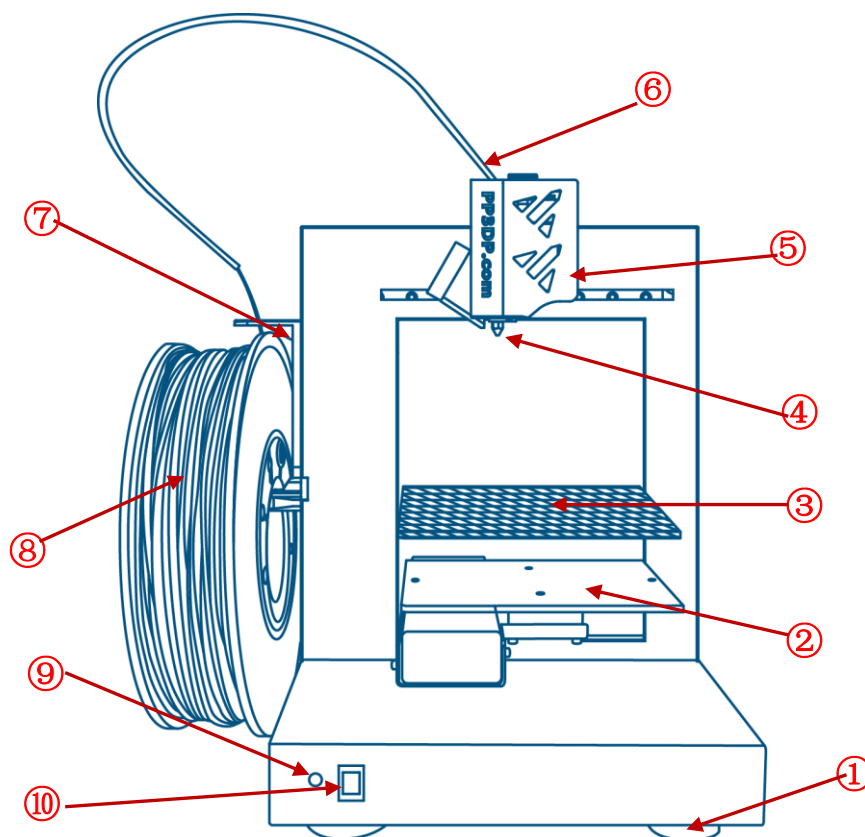

- | | |
|------------------|---------------------|
| ① Pedestal | ② Platform |
| ③ Perfboard | ④ Nozzle |
| ⑤ Extruder guard | ⑥ Filament tube |
| ⑦ Roller shaft | ⑧ Material filament |
| ⑨ Pilot lamp | ⑩ Initialize button |

Figure 2. Accessories



① USB cable



② Power adapter (20 V)



③ Filament tube



④ Screws



⑤ Cellboard

Figure 3. Tool kit



① Pen Knives



② Tweezers



③ Hex wrench



④ Shovel



⑤ Pliers



⑥ Gloves



⑦ Nozzle wrench



⑧ Clip

Figure 4. Axis

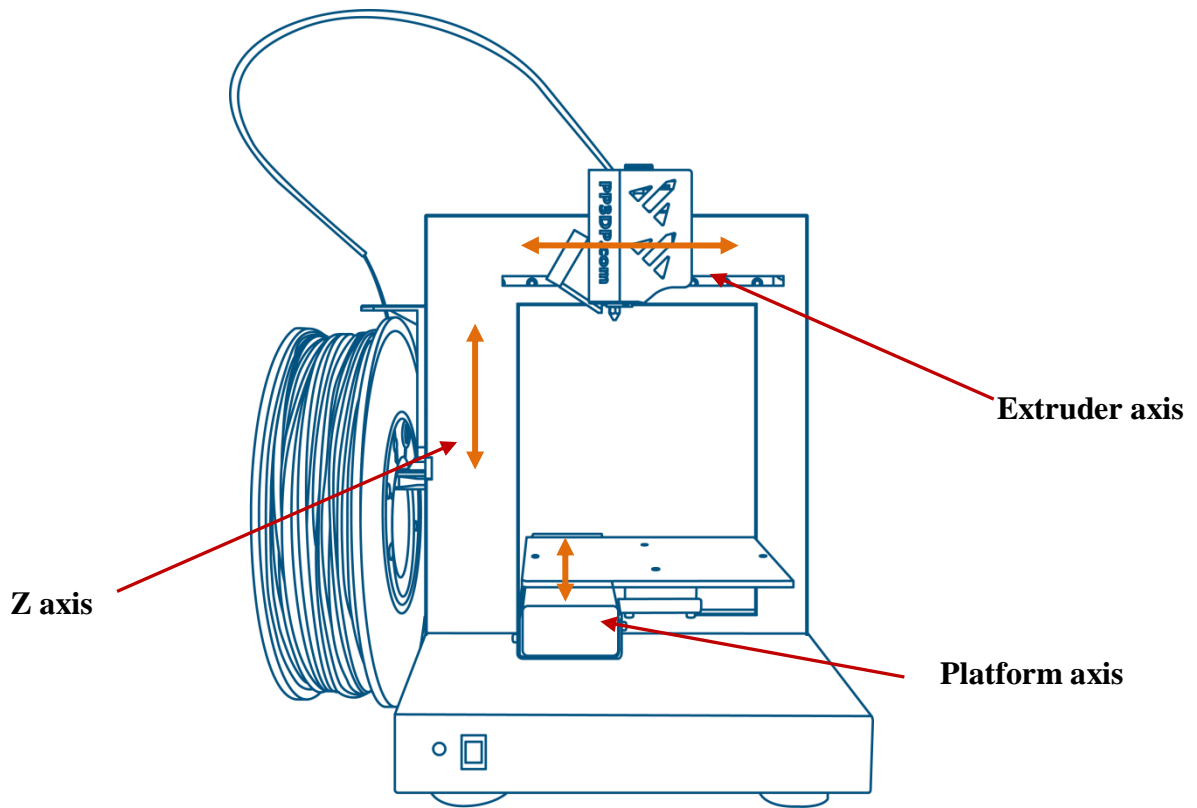
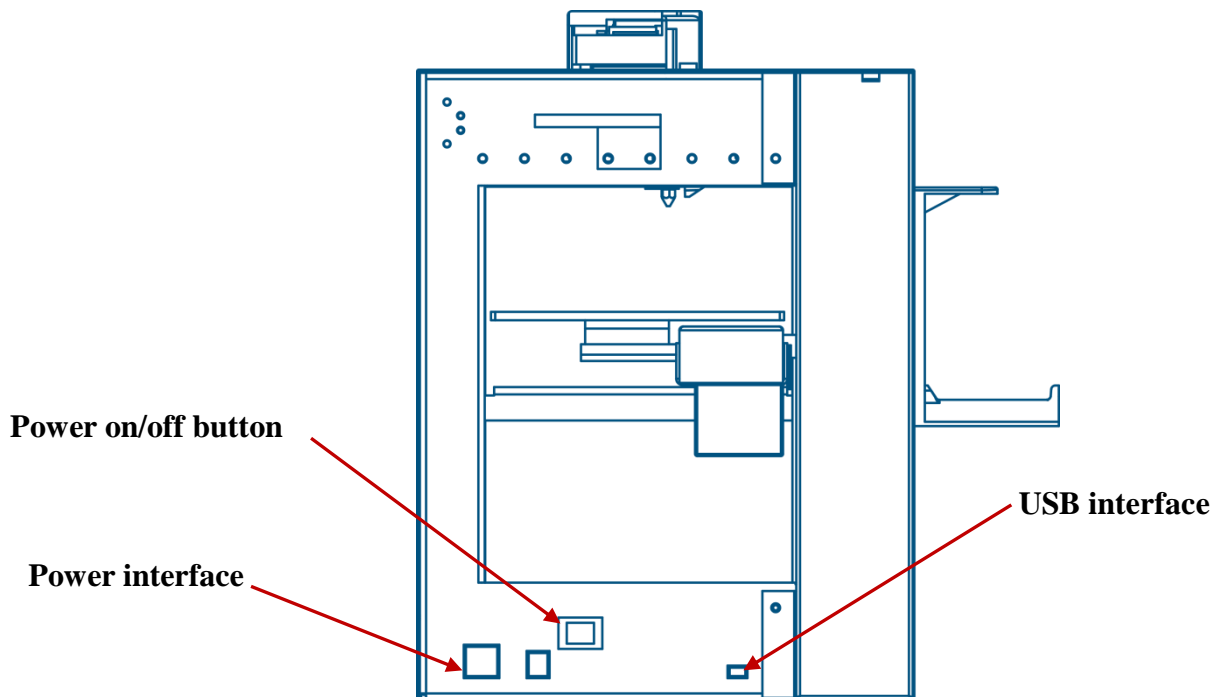

Figure 5. Back view of printer



2.2 Specifications

2.2.1 Printer Physical Characteristics

Printing Material	ABS or PLA
Material Color	White
Layer Thickness	0.20–0.40 or 0.25–0.35mm, depending on model
Print Speed	10–100 cm ³ /h
Print Size	140×140×135mm
Printer Weight	5 KG (11 lb)
Printer Size	245 × 260 × 350 mm

2.2.2 Specifications

Power Requirements	100-240VAC, 50-60Hz, 200W
Model Support	Auto-generated support
Input Format	STL
Workstation compatibility	Windows XP/Vista/7; Mac

2.2.3 Environmental specifications

Ambient temperature	15°C~30°C
Relative humidity	20%~50%

3. Operation

3.1 Preparation

3.1.1 Installation the printer

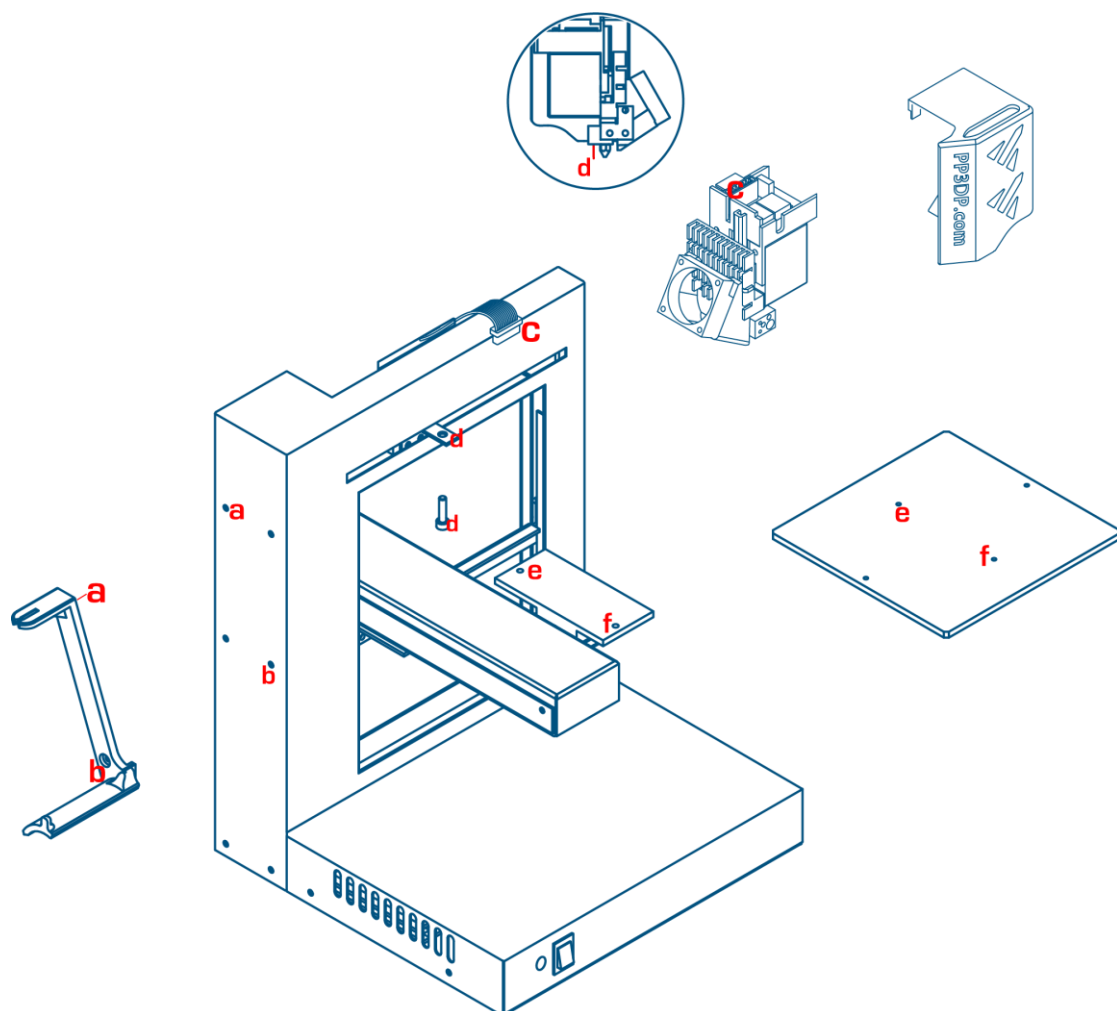

Assemble the four parts first following the diagram above.

Extrude Head

- (1) remove extruder guard from extruder head
- (2) unscrew the scrow (d) and fix the extruder head onto the holder
- (3) make sure the extruder is parallel with the Extruder axis make flat cable
- (4) Connect the extruder cable (14-pin) plug into the socket (c), and put the guard back on.

3. Operation

Platform: Raise the platform axis to a height at which you can reach under it to insert the screws. Line up the screw holes (e, f) on the platform with the screw holes on the heater base and insert the screws in from the bottom and tighten them.

Perfboard: Fix the perfboard on the platform with 4 clips at each corner. (see 3.3.5)

Roller shaft: Unscrew the screw (b) from the printer, and then fix the roller shaft with the screw. Please note that the roller shaft should lock into the screw (a).

Material Extrude (top view)

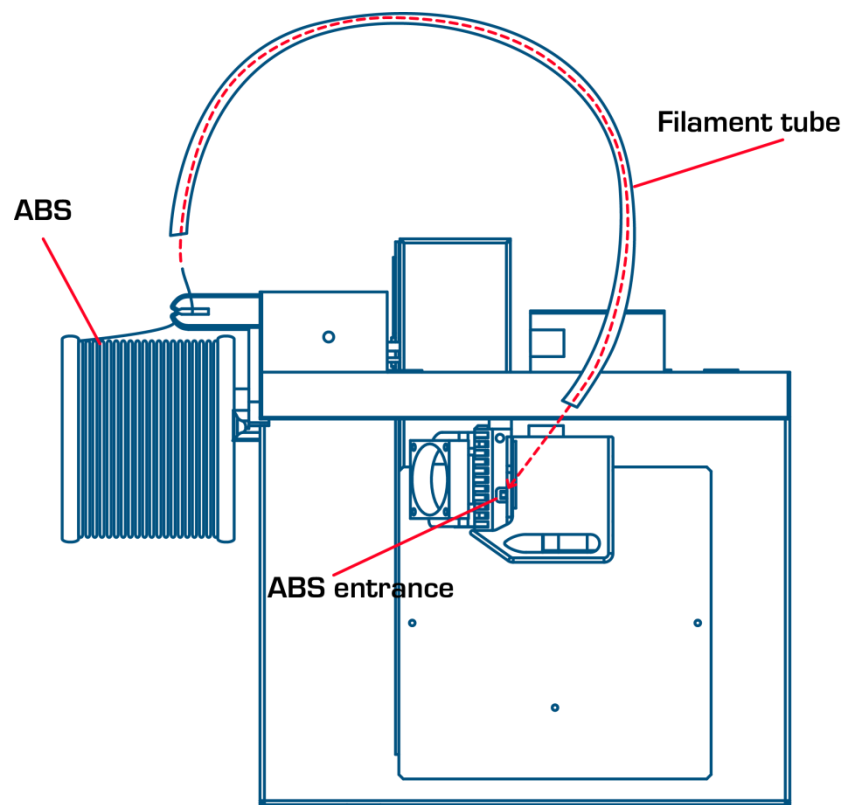

- (1) Connect the power adapter to the power interface.
- (2) Insert the end of ABS filament into the Filament tube.
- (3) Start the UP! Software (refer to the software install procedure in 3.1.2 if you have not already installed it), and press the “Extrude” button in the “maintenance” dialogue box, which is accessed from the “3D Print” menu.
- (4) After the printer nozzle has warmed up to 260°C, the printer will beep. Push

3. Operation

the filament into the hole at the top of the extruder head and hold it there with some gentle pressure until the extruder motor grabs it and starts pulling it through the extrusion head. The extruder will then automatically extrude a thin filament of material.

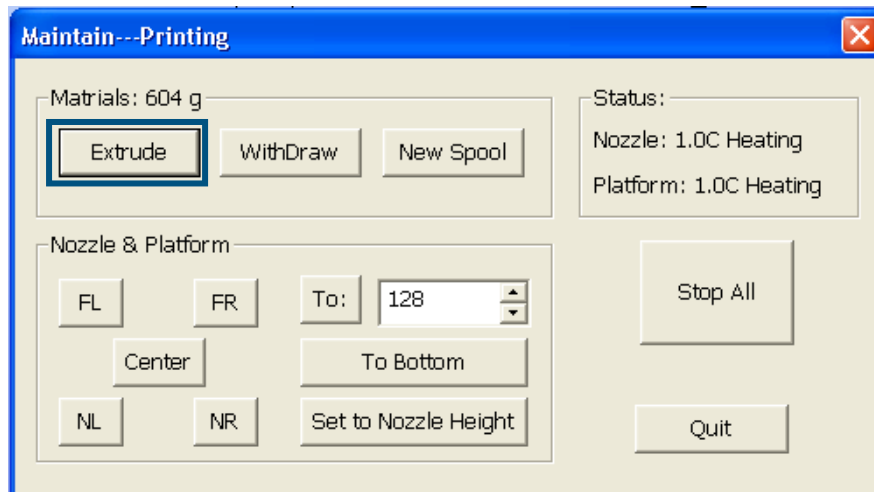

(Windows version)

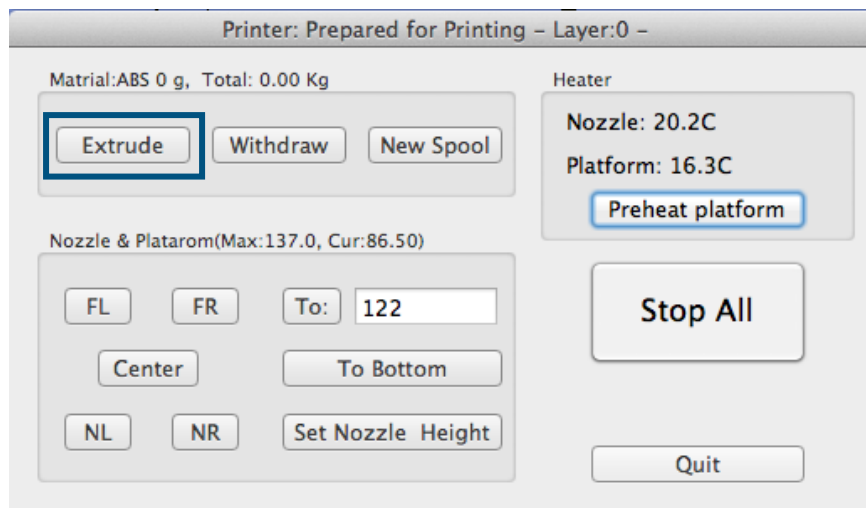

(Mac version)

3.1.2 Installing the software

Start the UPx.xx setup.exe file and install it to the specified directory (Default is Program files/UP). Note: This installs the UP software, the UP drivers, and the UP sample files into your Program files/UP folder.

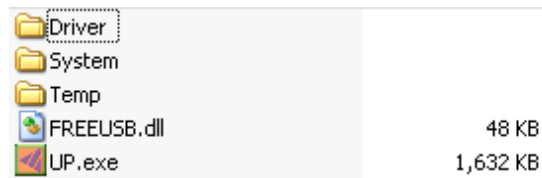

3.1.3 Installing drivers

Connect the printer to a computer with the USB cable. The computer should pop up the “Found New Hardware Wizard” window. Choose “No, not this time”, and then “next”. Then choose “Install from a list or specific location (Advanced)”, then “Next”.

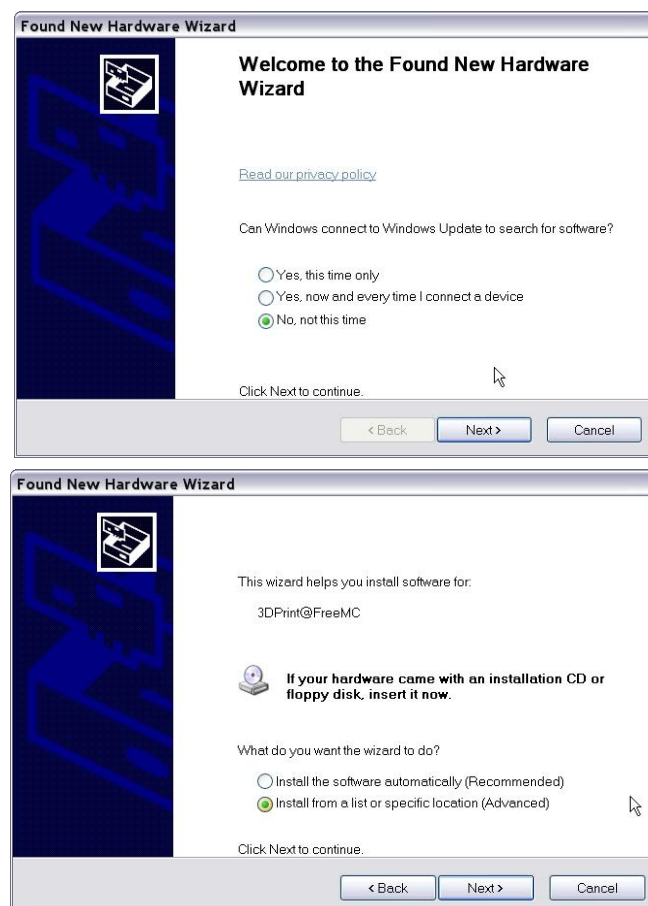

3. Operation

Click “Browse”, and choose C:\Program Files\UP\Driver, then “Next”.

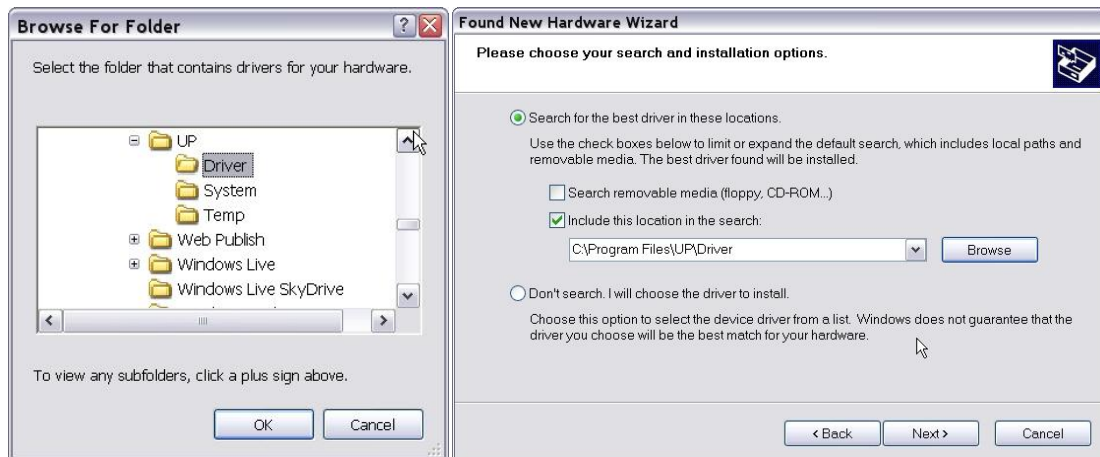

The following dialogue box pops up. Choose “Continue Anyway”, and the drivers will install automatically.



If you have any problems installing the drivers, or get a "Winusb.dll not found" error, please refer to the driver section in the troubleshooting section of this manual.

3.2 Using the basic functions

3.2.1 Start the program

Click on the  icon on the desktop. The program should open as follows:

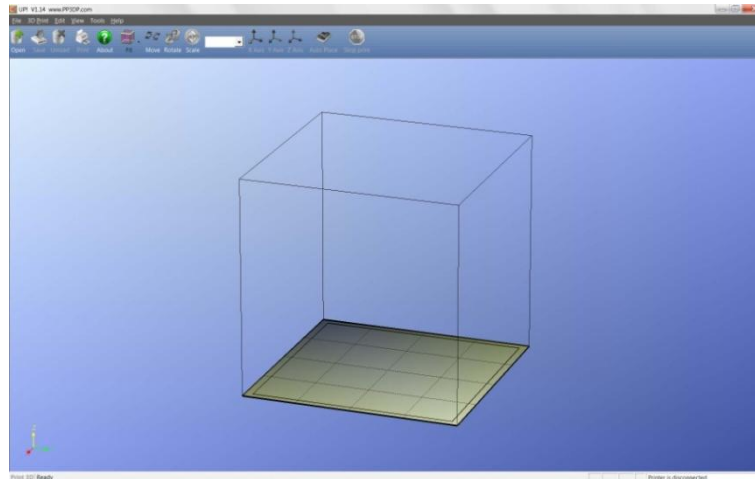

3.2.2 Loading a 3D model

Click “File / Open” or  on the toolbar and select the model you want to open. UP only supports **STL** files (which is the standard input format for 3D printing files), and the **UP3** format (which is UP’s proprietary compressed STL format)

Move the mouse pointer onto the model, and click the left mouse key. Some model information is presented in a floating window, as shown below:

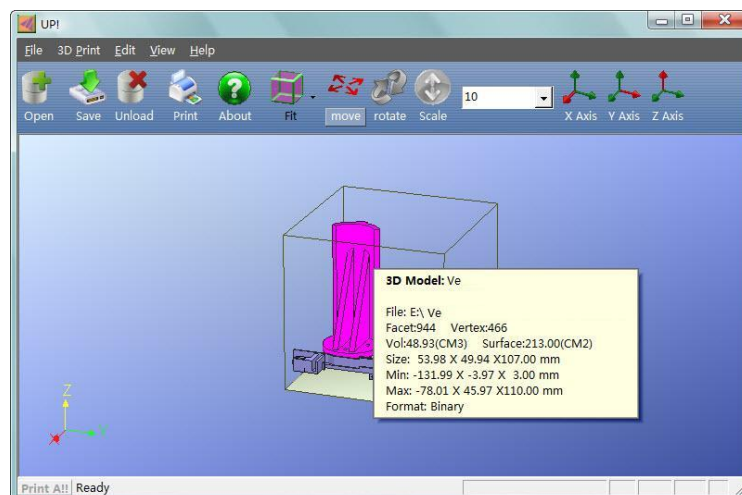

(Windows version)

3. Operation

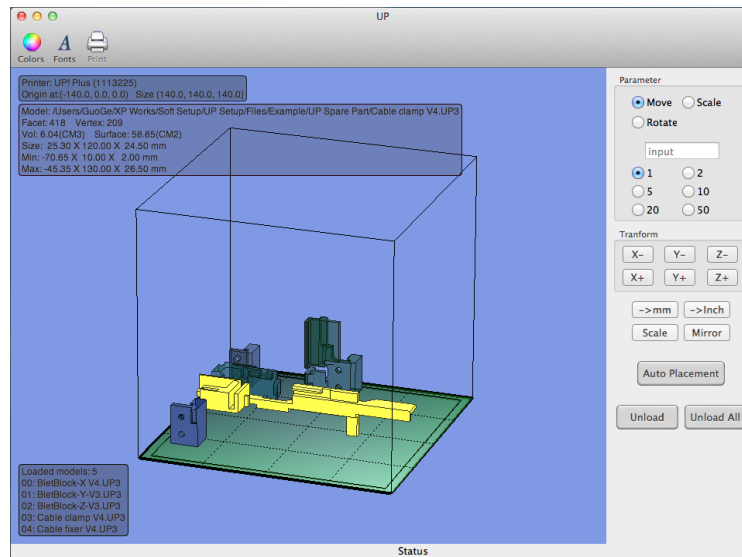

(Mac version)

TIP: You can open several models and print them all at the same time. Just repeat the open model procedure for each model you want to add. See the “Placing models on the build platform” section for more information.

Unloading the model: click the left mouse button on the model to select it, and then click “Unload” on the toolbar, or click the right mouse button while over the model and a context menu will appear. Choose unload the model or unload all models (if you have more than one file open and want to remove all of them).



Saving the model: Choose the model, then click “Save”. The file is saved in UP3 format and its size is 12%~18% of the original STL file. This is a convenient format for users to archive or transfer files.

Note on STL files: For a model to print correctly, all the faces of the models need to have their normal facing outwards. The Up software uses model colour to indicate whether a model is OK or not. The default colour used by the software when opening a model is a light grey/pink colour. If the normal are facing the wrong way, then the model is coloured in red.

3. Operation

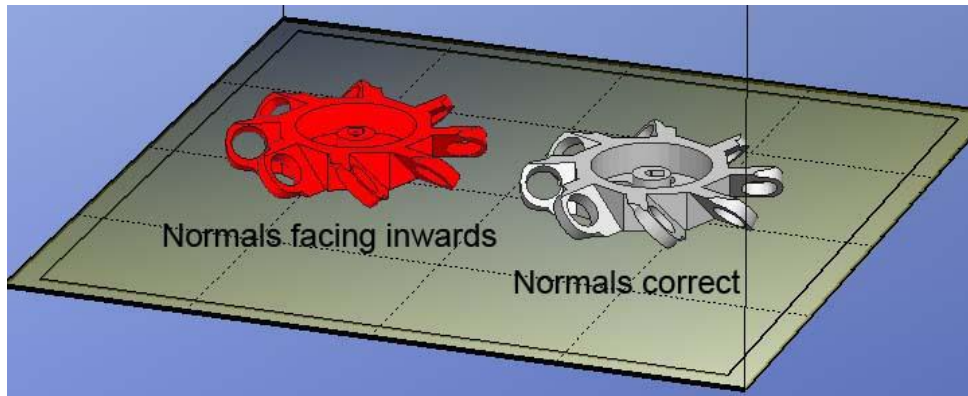

Fixing STL Files: The Up software has an option that attempts to fix models with bad surfaces. Under the “Edit” menu you will see a “Fix” option. Select the model with inverted surfaces, and click the “Fix” option to try and fix it.

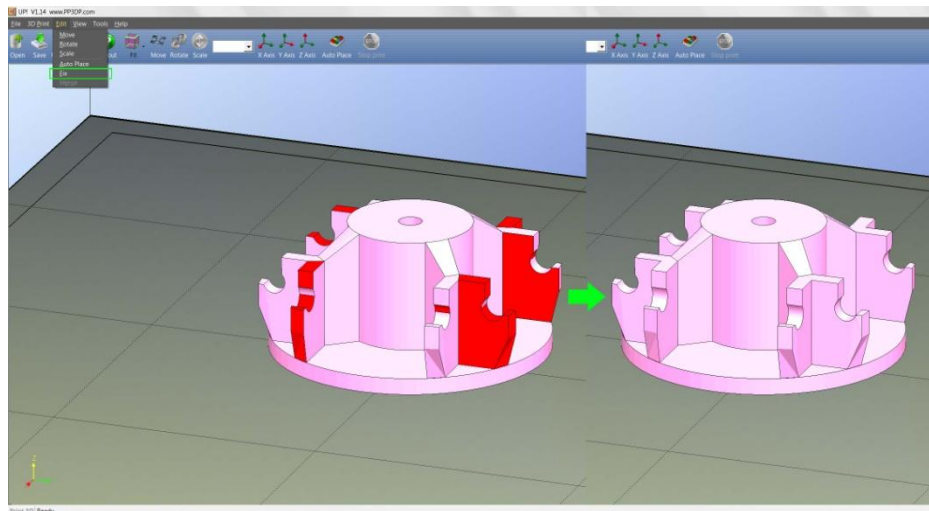

Merging models: Several separate models can be merged into a single file by using the “Merge” option from the “Edit” menu. Simply open all the models you want to merge and arrange them the way you want on the platform and click on the “Merge” option. When you then save the file, all the components will be saved as a single STL file.

3.2.3 View Options

To observe the target model in different ways, use the mouse to control the view.

Rotate: Press the middle mouse button and move the mouse: The view can be rotated and observed from different angles.

Pan: Press Ctrl and the middle mouse button at the same time and move the mouse: This causes the view to pan. You can also use the arrow keys to pan the view.

Scale: Rotate the mouse wheel: The view gets zoomed in or out.

View: The system has 8 preset standard views stored under the “View” button on the toolbar. Click the View button on the toolbar (the startup value for the View button is “Fit”) to find these options:



(Windows version)

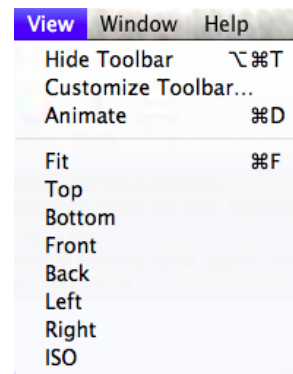
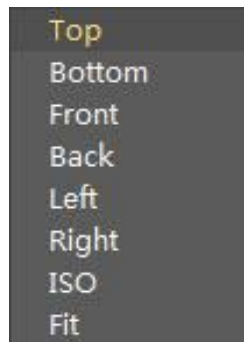

(Mac version)

3.2.4 Model transformations

Model Transformation can be achieved through the Edit menu or the toolbar:

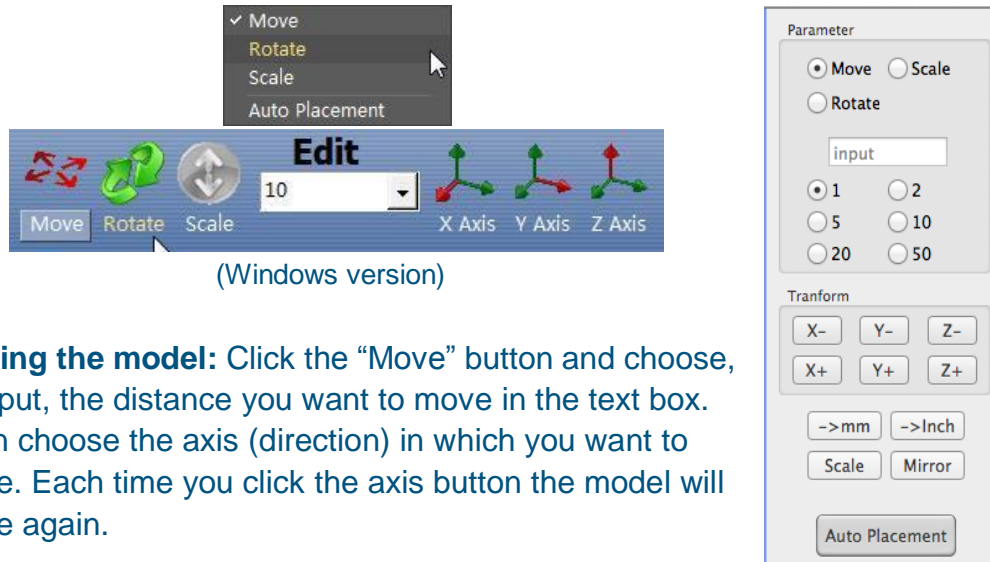

(Windows version)

Moving the model: Click the “Move” button and choose, or input, the distance you want to move in the text box. Then choose the axis (direction) in which you want to move. Each time you click the axis button the model will move again.

For example: Move the model -5mm along Z axis (or down 5mm). *(Mac version)*
 Procedure: 1. Click on “Move”; 2. Input “-5” in the text box; 3. Click the “Z axis”.

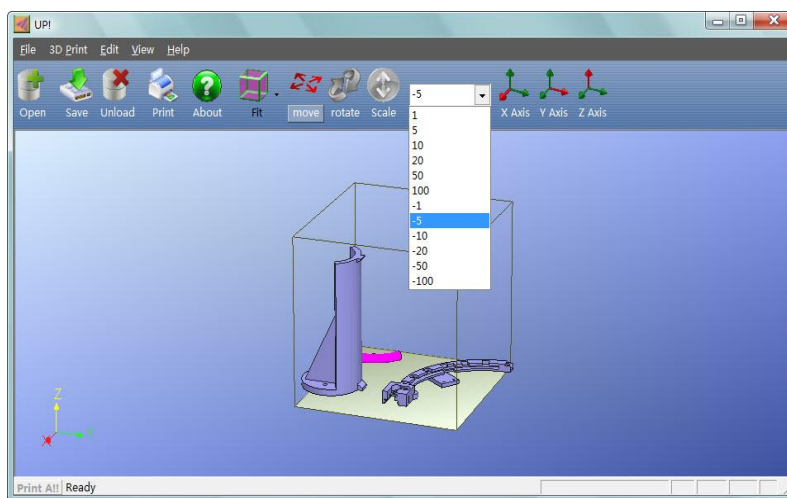

Tip: If you hold down the ‘Ctrl’ key, you can simply drag the model to whatever position you want.

3. Operation

Rotating the model: Click the “Rotate” button on the toolbar, choose or input how many degrees you want to rotate in the text box, then choose the axis to rotate around.

For example: Rotate the model around Y axis by 30°.

Procedure: 1. Click “Rotate”; 2. Input 30 in the text box; 3. Click “Y axis”.

Note: positive numbers rotate counterclockwise and negative numbers rotate clockwise.

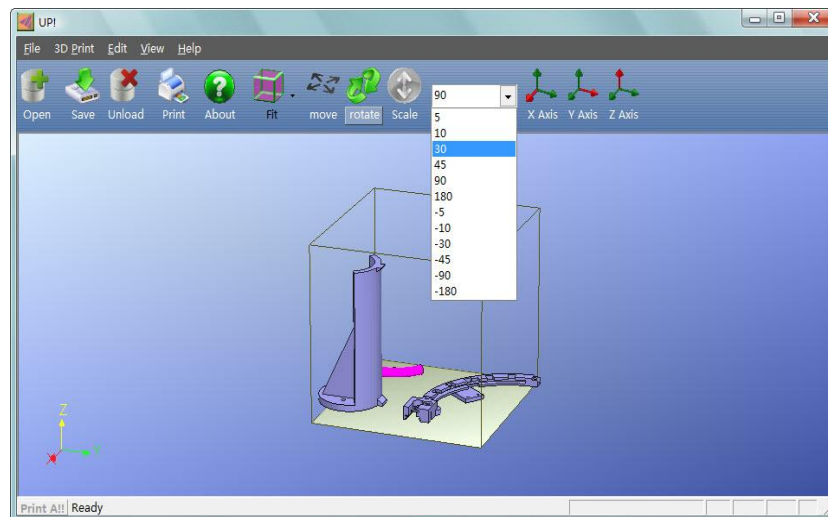

Scaling the model: Click “Scale”, choose or input a scaling factor in the text box, and then either scale the model uniformly by clicking the scale button again, or choose the axis around which you want to scale if you only want to scale in one direction.

Example1: Scale up the model uniformly by 2.0 times.

Procedures: 1. Click “Scale”; 2. Input 2.0 in the text box; 3. Click “Scale” again.

Example2: Scale up the model by 1.2 times along the Z axis only.

Procedures: 1. Click “Scale”; 2. Input 1.2 in the text box; 3. Click “Z axis”

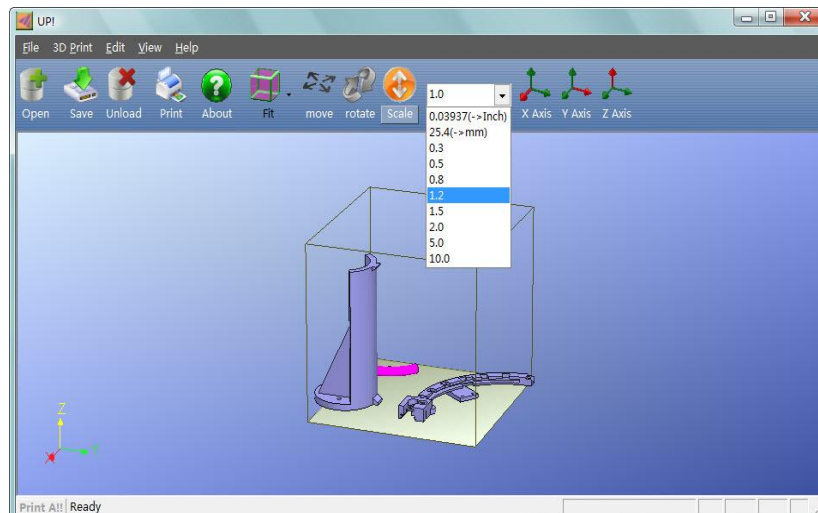

Unit Conversion: This option is provided as a convenient way to convert metric models to imperial, and vice versa. To convert an imperial model to metric, select the 25.4 option from the scale menu and click “Scale” again. To convert from metric to imperial, select the 0.03937 option and click “Scale”.

3.2.5 Placing models onto the build platform

Appropriately placing your models on the platform can have an effect on print quality.

TIP: In general, try to place your model in the centre of the platform.

Auto Place: Click the “Auto Place” button, on the far right of the toolbar, to automatically place the model on the platform. When there is more than one model on the platform, using “Auto Place” is recommended.

By Hand: Press the Ctrl key and choose the target model by pressing and holding the left mouse button. Move the mouse and drag the model to the desired position.

Using the “Move” button: Click the “Move” button on the toolbar, choose or input the distance in the text box, and then choose the axis for the direction in which you want to move.

NOTE: When more than one model is open, the gap between each model should be kept to at least 12mm to prevent the models sticking together.

3.3 Getting Ready to Print

3.3.1 Initializing the Printer

Before anything can be printed, the printer must be initialized. Click the “Initialize” option under the “3D print” menu. The printer will beep and the initialization procedure will begin. The printer will then return the platform and print head to the printer’s origin and beep again when it is ready.

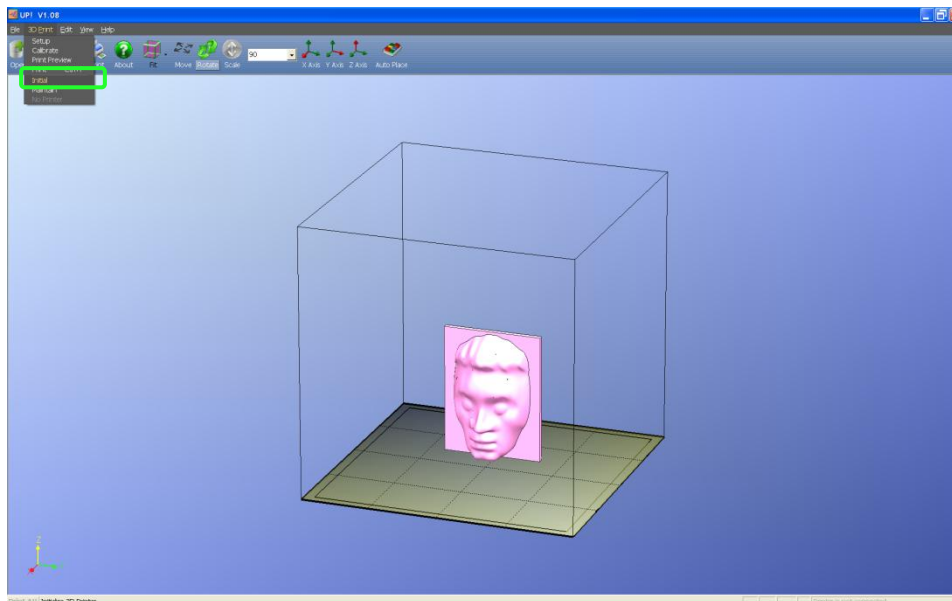

(Windows version)

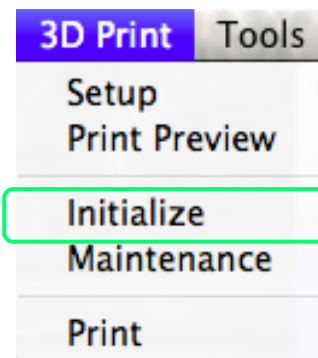

(Mac version)

TIP: If your printer is not responding properly, the first thing to try is to re-initialize the printer by clicking the ‘Initialize’ option from the ‘3D Print’ menu.

3.3.2 Calibrating the Nozzle Height

This section is probably the most important of the entire manual. Please read it carefully to ensure that you understand the nozzle height setup procedure, as it is vital to successful 3D printing.

To print successfully, the platform should be set to start at a distance of 0.2mm from the nozzle. As each printer is slightly different, this distance needs to be calibrated before starting to print. **The correct distance between the nozzle and platform is recorded in the “Nozzle” box of the “Print” screen (found under the “3D Print” menu, but we use the “Maintain” dialogue box to figure out what this distance should be.**

NOTE: It is only possible to move the nozzle to 1 mm higher than the height recorded in the “Print” screen. If, for example, the nozzle height in the “Print” screen is set to 130mm, you will only be able to move the nozzle up to 131mm in the “Maintenance” screen. This maximum value is indicated by the “Max” value shown in the platform and nozzle line of the “Maintain” screen.

If you are having problems adjusting the nozzle height in the “Maintenance” screen because it will not go high enough, close the “Maintenance” screen, open the “Print” screen, and set the nozzle height to 140mm (for example). Then go back to the “Maintenance” screen and continue with your nozzle height adjustments.

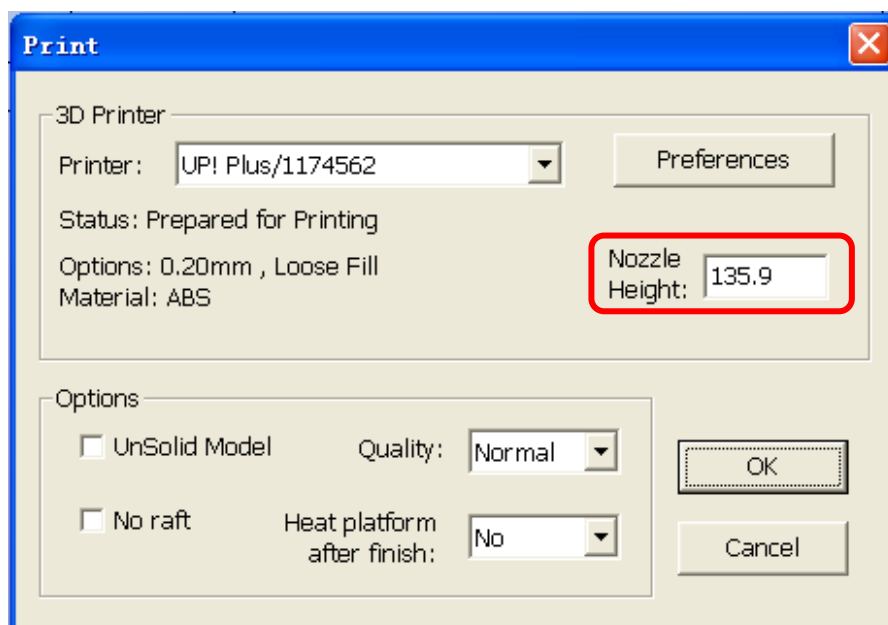

3. Operation

In the above example, this tells the printer that, after being initialized, and when a print job begins, the platform is 135.9mm away from the nozzle.

To figure out the correct nozzle distance, please follow these steps:

- 1 - Open the “Maintain” dialogue box from the “3D Print” menu. The current nozzle height is indicated as shown in the picture below.

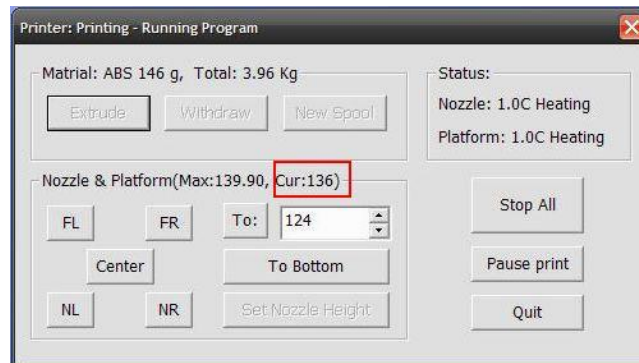

(Windows version)

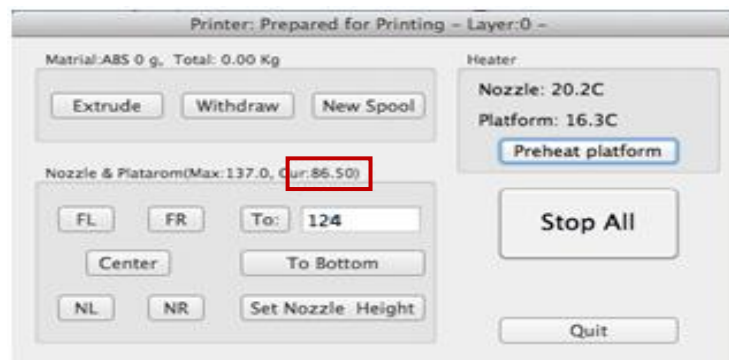

(Mac version)

- 2 - In the text box, type in the height to which you want the platform to move to, and click the “To” button. In the above example, the platform would move to 124mm above the platform’s origin.



- 3 - Check the distance between the nozzle and the platform. If, for example, the platform appears to be about 7mm away from the nozzle, increase the number in the text box to 130 and click the “To” button. Note that we have

3. Operation

only increased the number by 3mm instead of 4mm. The reason for this is that we do not want to crash the platform into the nozzle, so we want to increase the height in smaller and smaller increments as we get closer to the nozzle.

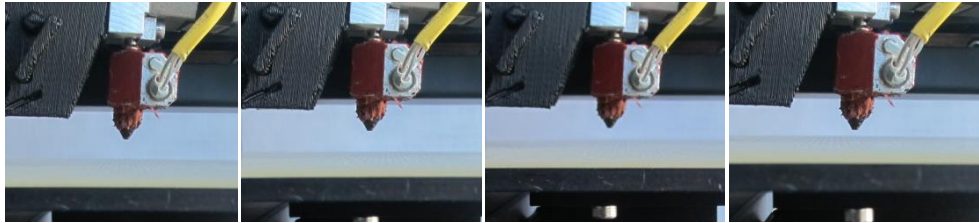

4 - Once you are about 1mm away from the nozzle, start increasing the number in the text box by 0.1mm increments and click the “To” button. Repeat this until you get to about 0.2mm of the nozzle.

5 - Click the “Set Nozzle Height” in the Maintenance dialogue to do test.

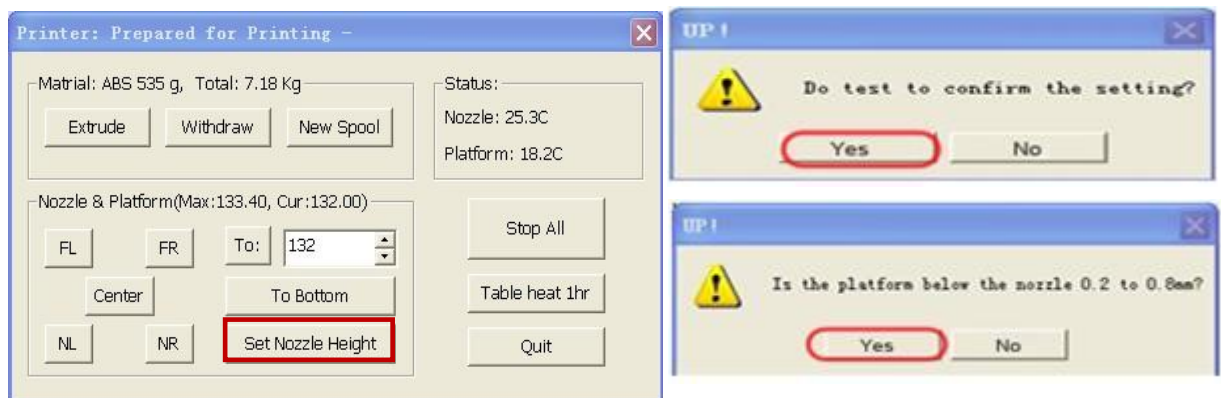

Click “OK”, the system will beep, and then the nozzle begins heating.



6 – After three beeps, the system will print a line for you to check if the height is ok.

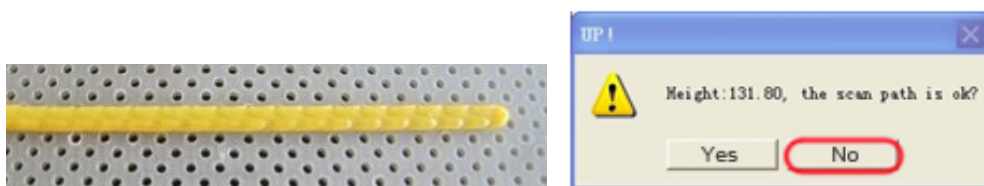

3. Operation

The path in the above picture is thick, seems just stick on the surface of the perfboard, and it can be easily pulled by nails. So click “No”, the height will increase 0.1mm and test again.

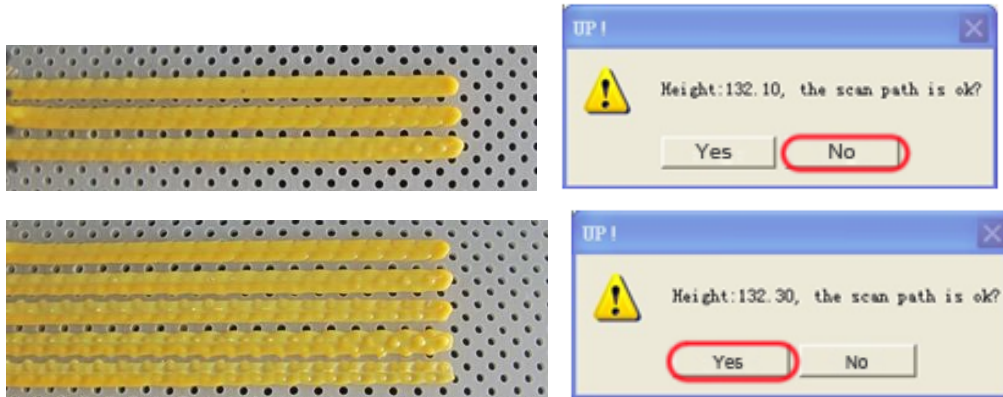

The last path in the above picture is quite wide and thin, and its surface is not flat. Viewed from the side, some of the materials have been plunged into the little holes of perfboard. And try to remove it by nails, if you cannot pull it out, click “Yes”. The nozzle height is well set.

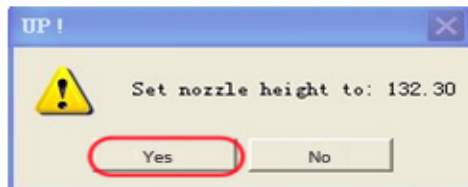

NOTE: Once you have setup the nozzle height once, you do not need to do it again as it is automatically recorded in the “Print” Screen.

TIP: You may need to regularly recalibrate nozzle height after moving the printer, or if you find the models are not adhering to the platform properly, or are warping.

TIP: If you happen to crash the platform into the nozzle while making height adjustments, it is good practice to re-initialize the printer before undertaking any other operations.

3.3.3 Leveling the print platform

After you have correctly calibrated your nozzle height, check that the nozzle is at the same distance at all four corners of the print platform. If it is not, you may need to adjust the platform until it is level with the nozzle at all 4 corners. There are 3 screw and 3 spring washers under the platform heater.

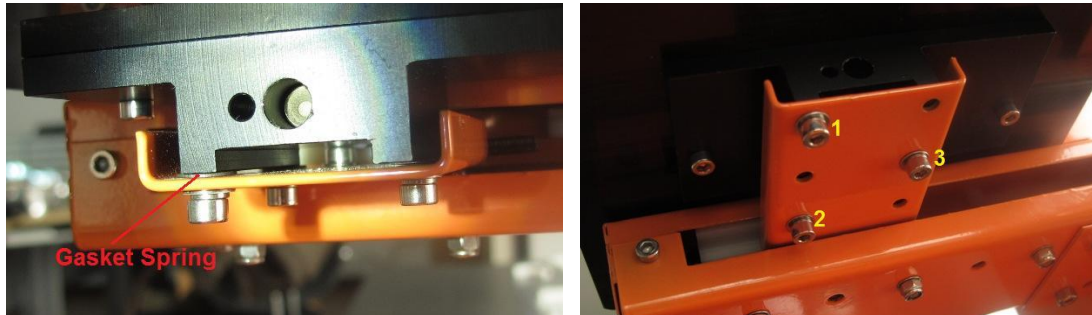

Loosen a screw and the related corner of platform will rise. Tighten, or loosen, the screws until you have the same gap between the nozzle and the platform at all four corners of platform.

Modification: One of the Up forum users, Drew Petitclerc, reports an improved level adjustment system, in which he has replaced the spring washers with a small stack of rubber disks which allows much more freedom and precision in leveling the platform. He removed the three shorter M3 screws and spring washers and replaced them with a stack of high temp stiff rubber disks centered between the three longer M3 screws. You adjust the level by tightening the appropriate screws and compressing the disks. Always adjust by tightening the screws, never by loosening them. The stack gives you a central, compressible, pivot point and three screws are optimal for balance. Add or remove disks to set overall Z spacing of plate to support arm.

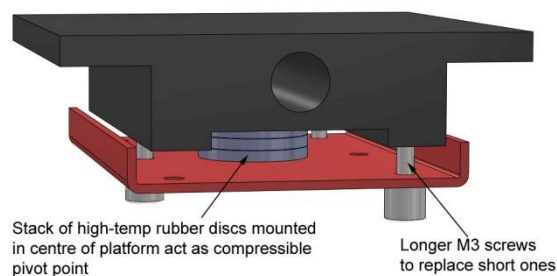

3.3.4 Other Maintenance Options

Click “Maintain” on the “3D Print” menu, and the following dialog box pops up:

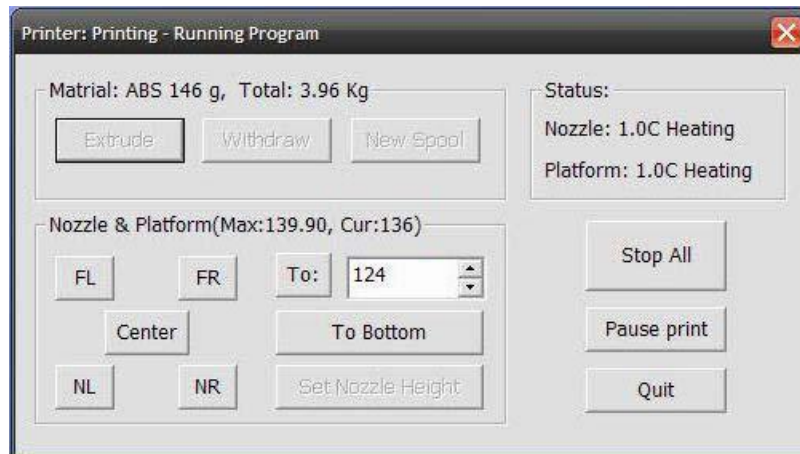

(Windows version)

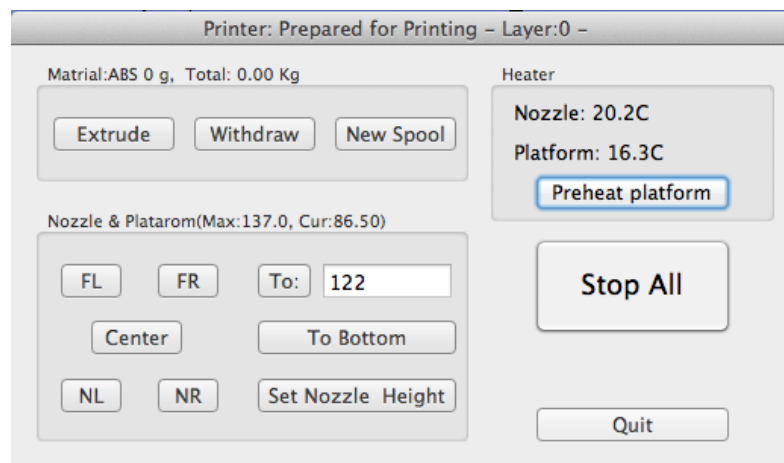

(Mac version)

Extrude: Squeezes material out of the nozzle. Click on this button, and the nozzle is heated. When the temperature is high enough (260°C), the material is squeezed out of the nozzle. The system beeps before material starts extruding, and it beeps again when finished. When changing the material (See section 6), this function is used to deliver the new material to the nozzle. This function can also be used to test whether the nozzle is working correctly.

Withdraw: Withdraws the material from the extrusion head. When the material runs out, or the nozzle needs to be changed, click this button. When the nozzle is up to temperature (260°C) and beeps, gently pull out the material. If the material gets stuck, pull it out it by hand.

3. Operation

New Spool: This is used so the printer can keep track of how much material has been used, and warn you if you don't have enough material left to print your model. Click this button and enter the value of how many grams of material you have on the current spool. If it is a new spool, the quantity should be set to 700 grams. You can also specify whether the material you are printing with is ABS or PLA.

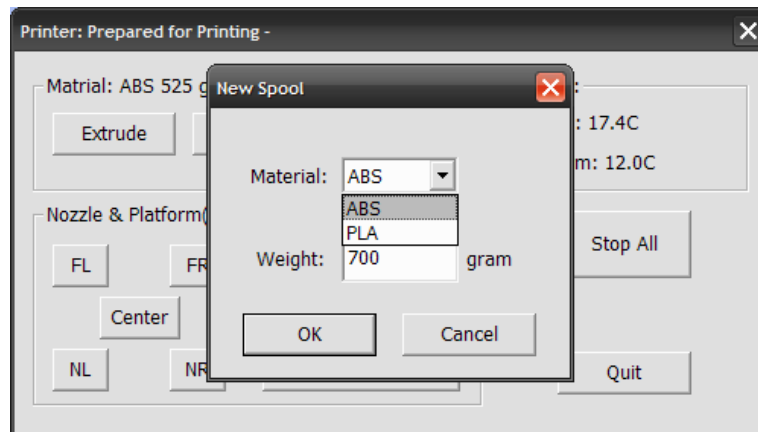

TIP: An empty spool weighs about 280 grams so, if you are installing a partially used spool, weigh it, and subtract 280 grams from the weight. This gives you the value to enter into the material text box.

Status: Displays the temperature of the nozzle and platform.

Stop All: Stops heating and all the movement of the printer. Once you click this button, the current model being printed is cancelled. You **CANNOT** resume a print job once the printer has been stopped. After you use the "Stop All" option, you will need to re-initialize the printer.

Pause Print: This button allows you to pause a print in mid-progress, but you can then resume the print job where it left off. This is very useful if you, for example, want to change the material colour mid-print. Another popular use for pausing a job mid-print is to allow fasteners to be inserted into printed cavities and then printed over to lock the fastener into place.

Nozzle & Platform: The five buttons (FL, FR, Center, NL, NR) control the position of the nozzle and the platform. The nozzle moves to the left and right; the platform moves forward and backward.

The "To" button controls the height of the platform, and is used in the nozzle height calibration procedure described in 3.3.2.

3. Operation

The “Bottom” button returns the platform to the lowest position.

Set Nozzle Height: Takes whatever value you have in the “To” box and transfers it to the Nozzle box of the setup screen.

3.3.5 Preparing the Platform

Before printing, the platform must be prepared so that the model adheres to the platform enough to be printed without the model moving. You can see six clips in the box, used to make the perfboard fix on the platform.

The perfboard is cut at 45 degrees angle with the edge, and just fits the size of the platform. When printing starts, plastic will have more chance to be pushed into all perforations, and this provides a stronger mechanical bond with the bottom surface that prevents it from later lifting.

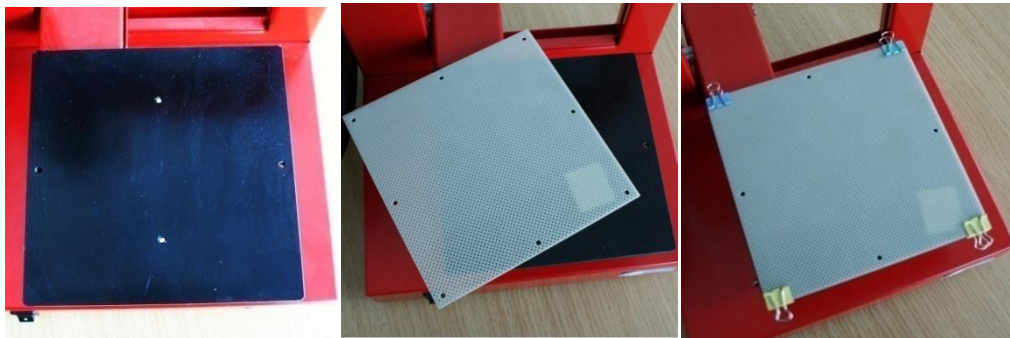

3.3.6 Print Setup Options

Click menu “3D Print->Setup”. The following dialog box pops up:

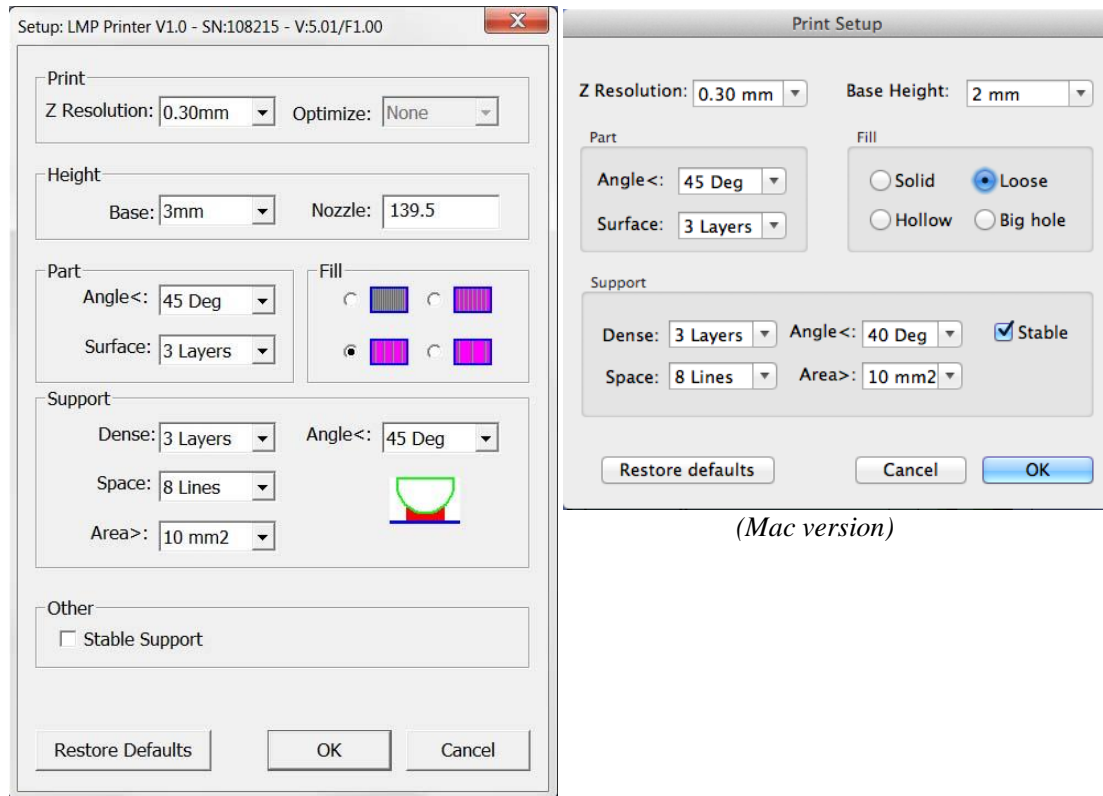

(Mac version)

(Windows version)

Print Options

Z Resolution: Sets the print resolution (layer thickness) of the printer. This can be between 0.2mm per layer to 0.4mm per layer (depending on the printer model).

Optimize: Disabled.

Height Options

Base: This is the thickness of the raft of material before the support layer is printed under the part. When the printer starts printing, it first prints a raft of non-solid material in which all the lines of support material are horizontal (along the Y axis). It keeps building up horizontal rows of support material for as many mm as you have chosen. Then, just before it gets to the bottom surface of the real part, it starts to build support layers perpendicular to the raft layers layer.

3. Operation

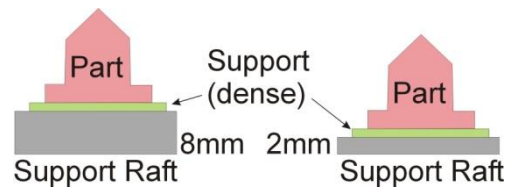

The default value for this parameter is set to 2mm.

Nozzle: represents the distance between nozzle and the print platform when it is at the bottom position. It is essential that this value be correctly set for good printing. See section 3.3.2. for instructions on calibrating your printer.

Part Options

Surface: This parameter determines how many layers form the bottom face of a part when it is not solid. For example, if you set it to 3, the machine will print 3 complete layers before going into non-solid mode. This does not, however, affect the side wall thickness on non-solid parts, which are all the same thickness (approximately 1.5mm) irrespective of the fill mode.

Angle: The part Angle determines at what point solid (dense) support material gets used. If the angle is small then the printer will add solid fill layers under the part surface. The thickness of this solid (dense) support is determined by the “dense” parameter under the Support options as described below.

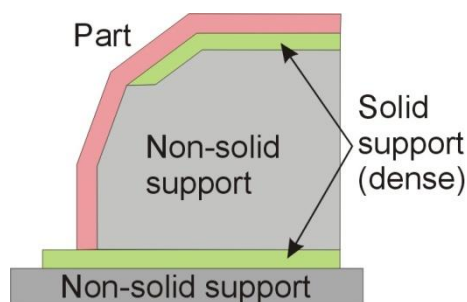

Fill Options

There are four ways to fill the interior of the parts, as described below.

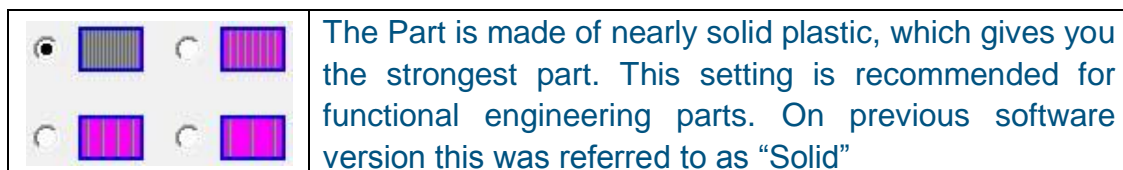

3. Operation

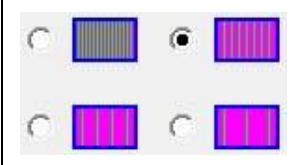
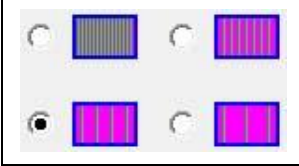
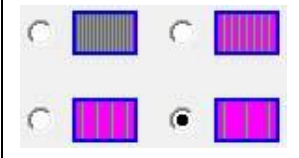
	<p>The part has an outer wall thickness of solid plastic (about 1.5mm), but its interior is filled with a reasonably small scaffold structure. On previous software version this was referred to as “Loose”</p>
	<p>The part has an outer wall thickness of solid plastic (about 1.5mm), but its interior is filled with a medium spaced scaffold structure. On previous software version this was referred to as “Hollow”</p>
	<p>The part has an outer wall thickness of solid plastic (about 1.5mm), but its interior is filled with a large spaced scaffold structure. On previous software version this was referred to as “Big hole”</p>

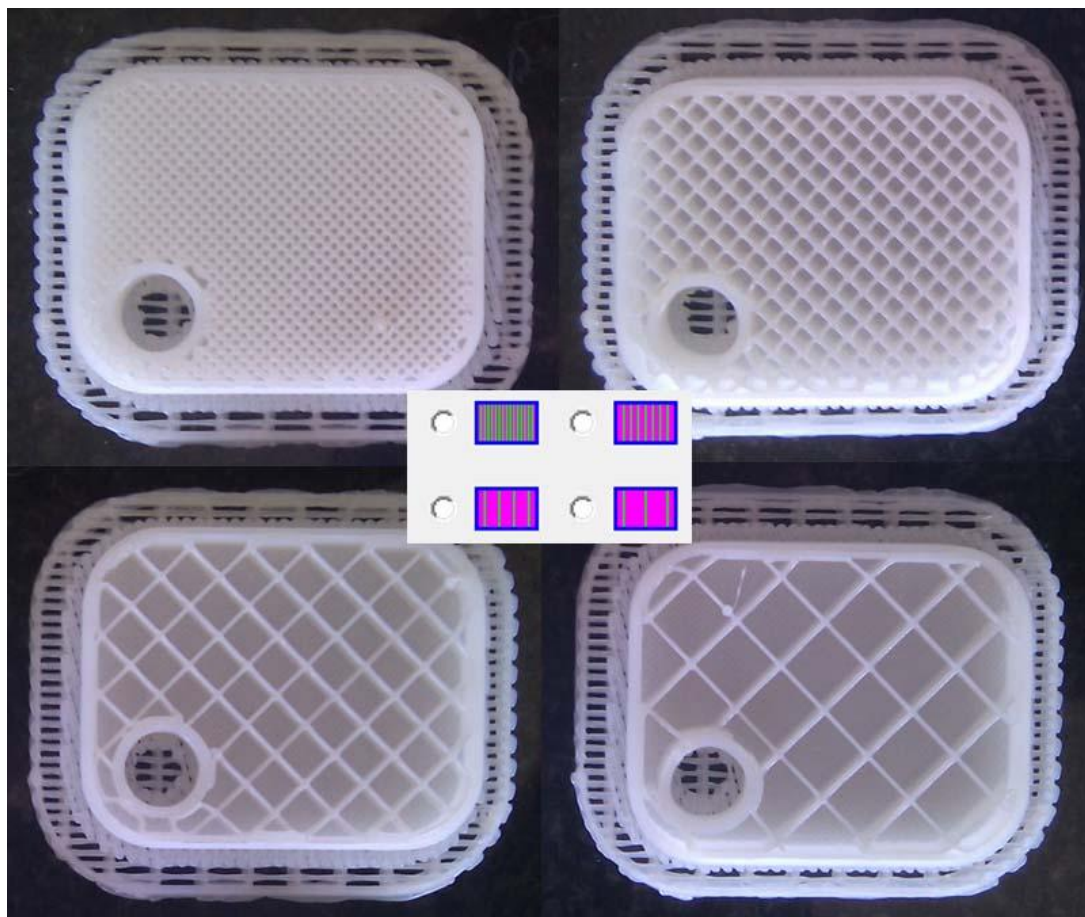

Support Options

Dense: This represents how many layers of ‘solid’ (dense) material form part of the support structure directly beneath the model.

3. Operation

Angle: Angle at which support material gets used. For example if 10° is used, support material only gets used if angle of surface is greater than 10° from horizontal (so support material is almost not used unless there is a direct overhang), If set to 50° than support material is used for any surface is greater than 50° away from horizontal.

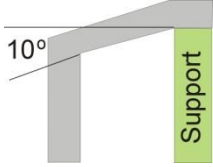
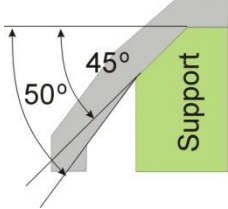
Set to > 10°	Set to > 50°
	

There is always a delicate balance between minimizing the amount of support material, versus the quality of the part, versus the difficulty of removing support material.

The orientation of the part on the print platform is also critical in determining both how much support material gets used, and also how difficult the support material will be to remove.

As a general rule, it is easier to remove support material from the outside of a part than from the inside. As can be seen in the picture to the right, the part would use a lot more support material if printed with the opening facing downwards than if it were facing upwards.

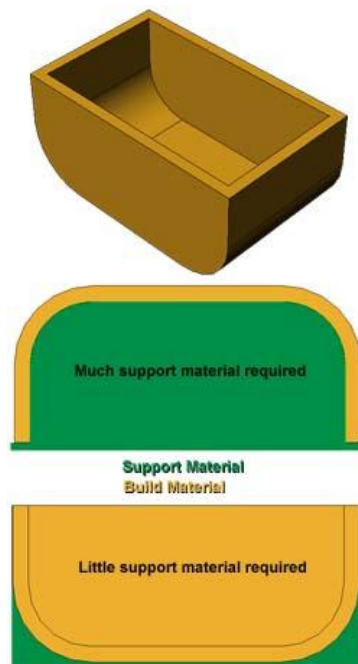

Space: The distance between the lines of non-solid support material. Changing this parameter requires some experience in balancing the quantity of support material used, ease of support material removal, and part print quality.

3. Operation

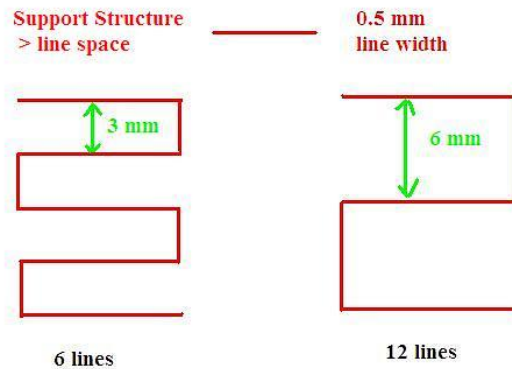

Area: The surface area above which support material gets used. When you choose 5mm^2 , for example, there will be no support if the overhanging area is less than 5mm^2 . Benefit? A little material is saved and a slightly faster print speed is achieved.

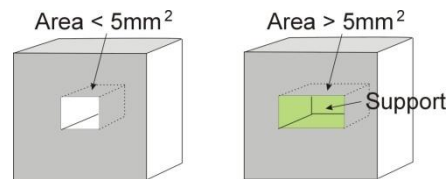

Other Options

Stable Support: Stable support creates support that is more solid, and the model is less likely to distort, but the support material is then more difficult to remove.

Tip: All setup and configuration settings are stored in the Up Software, not on the Up Printer. This means that, if you change to a different computer, you will need to repeat all the calibration and setup procedures.

4. Printing

TIP: One of the keys to successful printing on the Up is platform preparation and preheating. Particularly with large parts, there is a tendency for the edges of the part to lift from the platform (which is a little colder than the center) and cause the parts to warp. The best way to prevent this is to ensure that a) the platform is perfectly level, b) that the nozzle height is correctly set and that c) the platform is very well preheated. It also helps to run the printer in a room that is not too cold (ie warmer than, say, 18°C and free of drafts).

Please ensure the following points are taken care of before printing:

- ◆ Connect the 3D printer, initialize it, and set up the printing system. Load the model and place it properly on the virtual platform of the software window. Check if there is enough material for the model (the software will, generally, tell you if there is not enough material when you begin the print). If not, change the reel to a new one.
- ◆ For large models (over 40mm²) results can be improved by preheating the build platform. Click the “Preheat” option on the “3D Print” menu and the printer begins to heat the platform. Let the platform get up to 100°C before beginning to print.
- ◆ The little “door” in the wind barrier of extrude head is used to adjust the airflow to have good printing quality for some certain models. Generally, it should be closed (like the right picture), since warping or or split issue would be caused if blow too much.



Only for the ball-shaped models and models with very small features or sharp end (like tower), the “door” should be opened. Because the heat from the extrude head would be blown away soon with much blow, and models can be solidified in a very short time so that the surface would be better.

- ◆ Click menu “3D Print->Print”, and the print dialog box pops up. Choose “Preferences” to set the printing parameters. Click “OK” to begin to print.

3. Operation

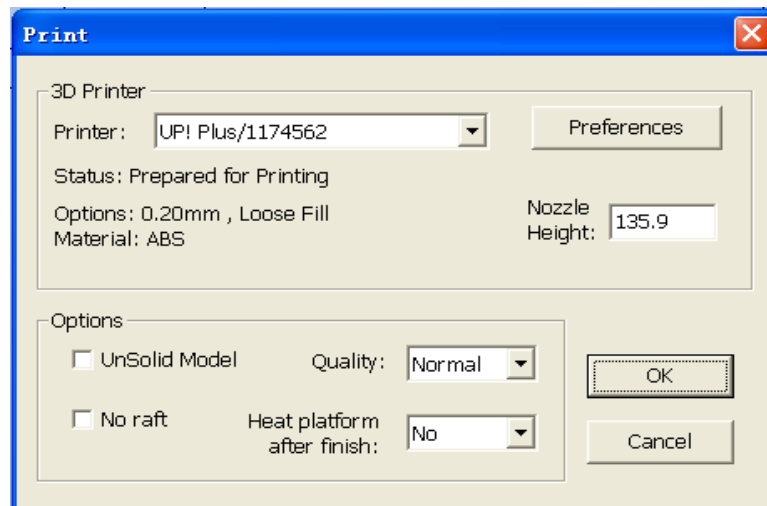

(Windows version)

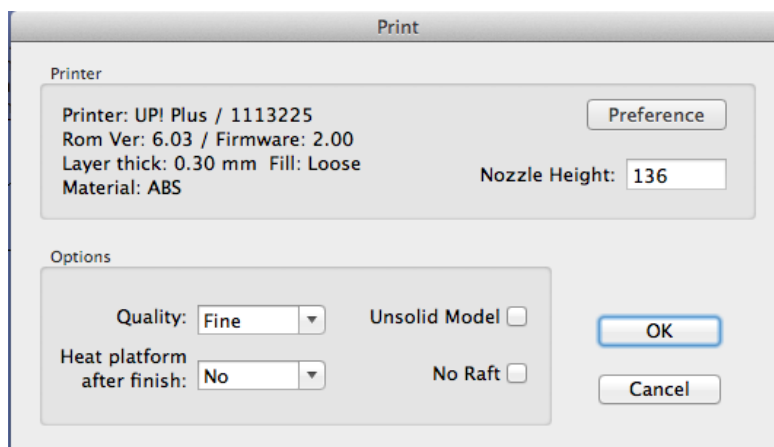

(Mac version)

Print Options:

Speed: Fine, Normal or Fast. This simply determines the speed at which the printer moves. As a general rule, the slower you print, the better the quality of the parts. For tall parts, running at Fast speed can be problematic as the printer can vibrate to the extent that print quality is affected. For large surface area parts, the Fine setting can be problematic as the printer takes longer to print the part and the corners are therefore more likely to lift a little bit.

UnSolid Model: This function is useful for printing STI files that are not perfect. A perfect STL file is a fully enclosed surface, with no holes in the surface skin, and no overlapping surfaces. If your file is not perfect, this option should allow you to print it anyway.

3. Operation

TIP: Once the print has started, you can unplug the PC from the printer. The print job is stored in the printer's internal memory, so the PC is no longer required.

Calculating model costs

The main factor that will affect model cost is the part interior fill structure, and support material. If, for example, one is printing a cube measuring 30mm x 30mm x 30mm, with a layer thickness of 0.2mm, the following quantities of material are used depending on the print mode.

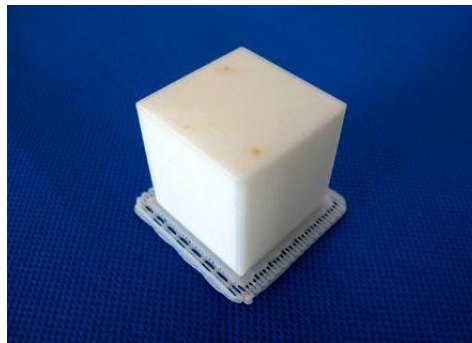

Model info: 30x30x30mm layer thickness: 0.2mm

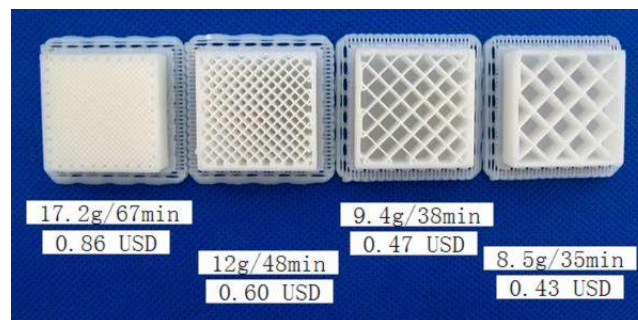

The prices above are calculated with ABS from PP3DP.com at \$35 USD for a 700g roll. The easiest way to calculate how much material will be used for your model is to use the “Print Preview” option under the “3D Print” menu. This will tell you the total weight of material used, including the raft and any support material.

5. Model Removal

1. When the model has finished printing, the printer will beep, and the nozzle and platform stop heating.
2. Remove the printer platform from the printer by removing the 2 screws at the bottom of the platform.

3. Operation

3. Gently slide the spatula under the model and slowly wiggle it back and forth to pry loose the model. Remember to use gloves as the platform and model may still be hot.



CAUTION: It is strongly recommended that you wear the gloves to remove the model from the perfboard.

Removing Support Material



Printed models are composed of two parts. One part is the model itself, and the other part is the support material used to support any overhanging parts of the model.

The support material is the same physical material as the model material, but the support material is printed at a much lower density. It is very easy to distinguish the model from the support material so it is easy to remove.

Have a look at the teapot in the above pictures. The left picture shows the teapot with support material removed, and the right picture shows the teapot with its support material still attached.

3. Operation

The support material gets removed using a combination of tools. Some material can easily be cracked off by hand. Support material close to the model is easier to remove using tools such as wood carving chisels, long nose pliers, or wire cutters.



It takes some practice to get comfortable with removing support material, but it can become quite an enjoyable and therapeutic task!

CAUTION: ALWAYS WEAR SAFETY GLASSES WHEN REMOVING SUPPORT MATERIAL, ESPECIALLY WITH PLA MATERIAL.





CAUTION: The support material and the tools are sharp. Wear gloves and safety glasses when removing the part from the printer.

6. Maintenance

Changing the Material

- ◆ First withdraw the leftover material from the printer. Initialize the printer and choose “3D print->Maintain”. Click “Withdraw” and the system automatically begins to heat the nozzle. When the nozzle reaches the correct temperature, the printer will beep, and you can gently withdraw the material.
- ◆ Place a new spool of material on the spool holder, and pull it through the filament tube, until the material is about 10cm out of the tube, then insert it into the hole at the top of the extruder head.
- ◆ Select the “maintain” menu from the “3D Print” menu. Then press the “Extrude” button in the “maintain” dialogue. After the printer nozzle has warmed up to 260°C, the printer will beep. Push the filament into the hole at the top of the extruder head, with a little pressure, and the extruder will automatically extrude material. The plastic thread squeezed out of the nozzle should be thin, bright and smooth.

	<p>If the nozzle is blocked, remove the nozzle and clean it.</p>
 	<p>The extruder and platform are hot. Use gloves when working in this area of printer.</p>

Vertical Calibration

The Vertical calibration procedure allows you to ensure that the printer platform is perfectly horizontal and that the printer prints consistently in the X, Y and Z direction.

First, print the supplied Calibration model on your printer. The calibration file is in C:\Program Files\UP\Example.

3. Operation

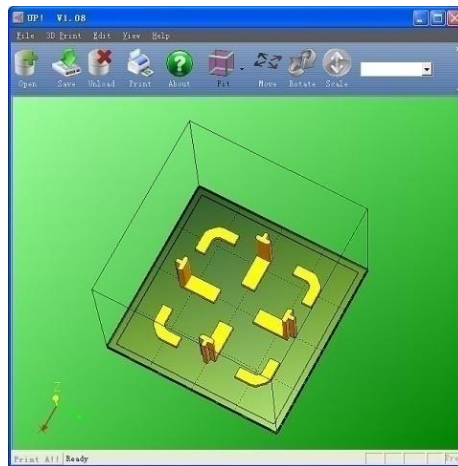

After the calibration model is printed, measure the X1 and X2 length, as shown in the pictures below.

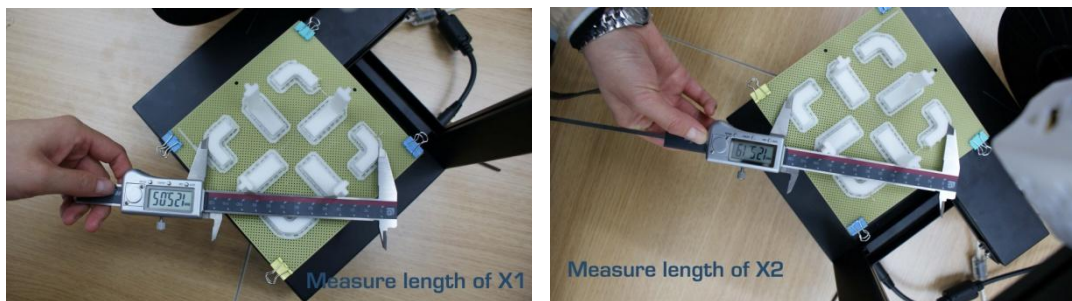

Open the “Calibrate” box form the “3D Print” menu and enter the measured X1 and X2 values into the appropriate boxes.

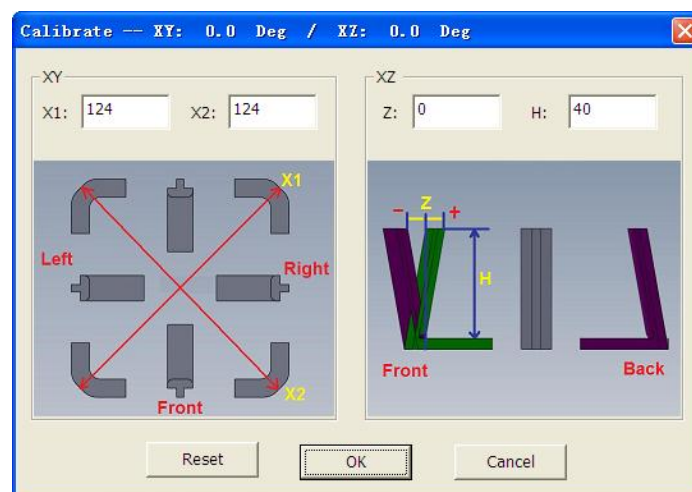

3. Operation

IMPORTANT NOTE: Before you enter any new calibration values, always click the “Reset” button, otherwise the new values get added to the old ones. Before you enter any new values, the bar at the very top of the screen should read: XY: 0.00 deg / XZ: 0.00 deg.

Next, take down the Front Centre ‘L’ shaped component, and measure its deviation. Put the exact value into the Z box. If it deviates to the right side, the value to be put into the Z box will be a positive value. If the deviates to the left, the value to put into the Z box will be a negative value.

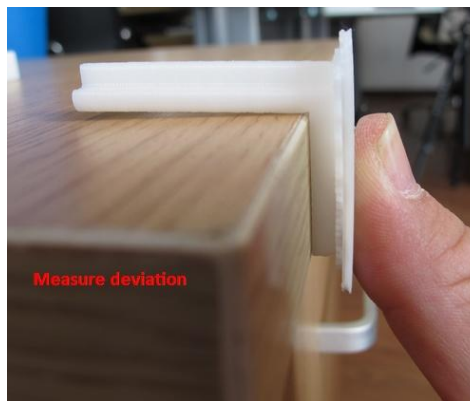

Finally, measure the height of Front Center component, which should be 40mm if it is not scaled. Enter the exact measured value into the “H” box of the “Calibrate dialogue box.

Click “OK” to record all these values and exit the calibration window.

Cleaning the nozzle

After a lot of printing, the nozzle may be covered with a layer of oxidized ABS. When the printer is printing, this oxidized ABS may melt on the nozzle, and may create discolored spots the model. To avoid this you need to regularly clean the nozzle.

Firstly, preheat the nozzle in order to melt the oxidized ABS. Use the “Extrude” button on the “Maintain” dialogue box, then lower the platform to the bottom.

Lastly, use some heat-resistant material, like 100 percent cotton cloth or soft paper. A pair of tweezers will also be required. Then clip paper or some other heat-resistant things with tweezers to clean up the nozzle.

3. Operation

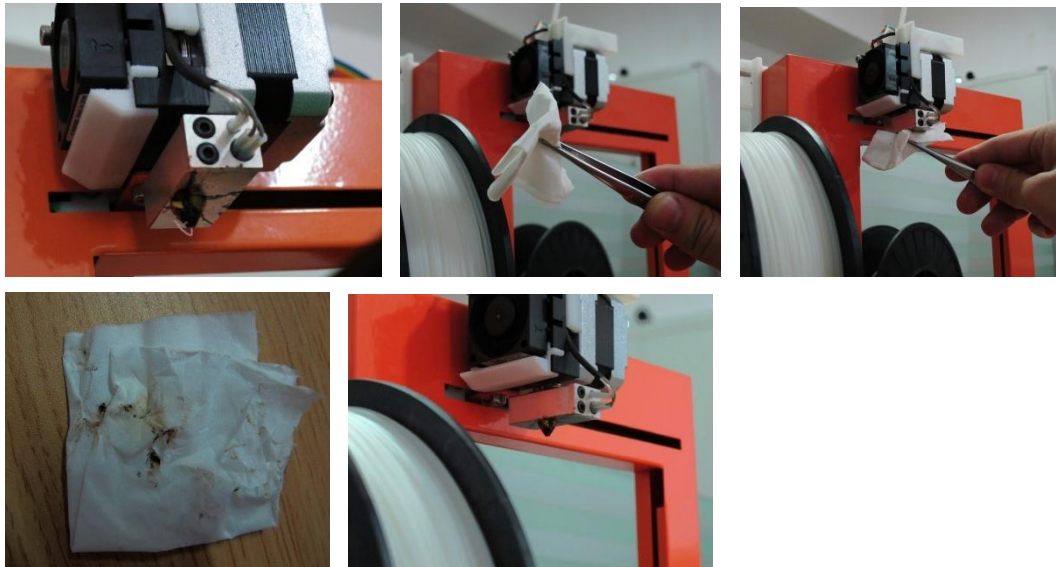

TIP: Many users also soak their nozzle in acetone to clean them, or even use an ultrasonic cleaning bath to help clean their nozzles

Removing / Changing the nozzle

Should the nozzle become blocked, you may need to remove it in order to unblock, or change it. To remove the nozzle, use the nozzle wrench provided in the toolkit that comes with your Up Printer. It is, generally, easiest to remove the nozzle when it is hot and, should you need more torque than can be applied with the small screw on the wrench, replace it with the small Allen key from the toolkit to provide more power.



Cleaning the platform

If you are using the special green paint on your platform, the platform requires cleaning after a few prints to get it back to a smooth surface. Simply remove the platform from the machine and soak it in water for a few hours and the paint will peel off easily.

Once clean, repaint it with green paint, or cover it with blue masking tape.

Lubrication of bearings

The bearings on the Up Printer may occasionally require a bit of lubrication to keep it operating smoothly. The recommended grease to use is lithium grease. When lubricating the bearings, first clean off as much old grease as possible from the bearings, and then apply new grease to the bearing and slide the platform in the appropriate direction to spread the grease.

Spare parts

Almost all the plastic parts on the printer are printed by the Up printer itself. If you need to print spare parts for your printer, the files for all spare parts can be found in the C:\Program Files (x86)\UP\Example\UP Spare Part folder.

7.0. Tips & Tricks

Large parts can sometimes have their corners lift from the platform, which causes the part to distort. This is caused by uneven heat across the surface of the platform. Preheating the platform before beginning large parts is essential to minimize this lifting. Also, the faster you can print such parts, the less lifting you are likely to get. Some ways to increase print quality include:

- If possible, try to avoid printing such large parts in solid mode.
- Set the layer resolution to as high as you can get away with.
- Print the part in “Fast” mode.

Removing the screws that attach the print platform to the printer can be inconvenient. This can be made much easier by printing little screw caps with handles on them, that get epoxied to the screw heads. This means the screws can then be removed without the need for a tool. Files for the screw caps can be downloaded from: <http://www.thingiverse.com/thing:4113>

After printing, use a fast drying epoxy glue to glue them onto the screws, Clamp the screw and cap in a vice until the glue is dry to prevent the screw cap not sitting firmly on the screw.

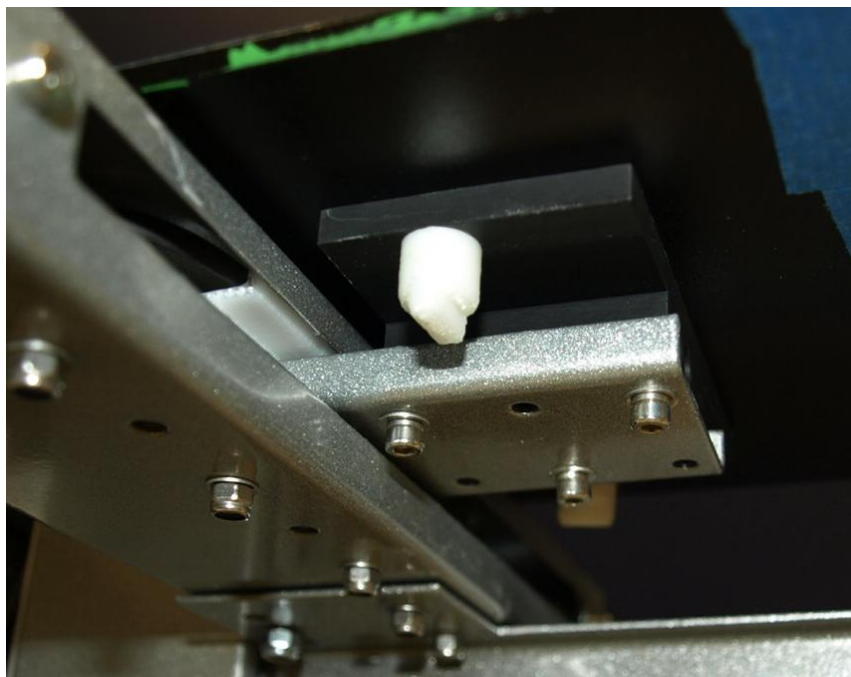

3. Operation

Regularly check your nozzle height! It can change for a number of reasons, some of which you may not even be aware of. To check your nozzle height, refer to section 3.3.2

To get the best results out of your Up printer, the print platform must be perfectly lined up with the Nozzle. This means that when you set the nozzle height, it should be exactly the same distance from the nozzle at all four corners, and the center, of the print platform. If this is not the case, please follow the “leveling the print platform” procedure listed in 3.3.3

8. Troubleshooting

Problem or error message	Solution
No power	Verify power cord is securely plugged in.
Extruder or platform fails to reach operating temperature	1. Verify printer has initialized. if not, initialize the printer
	2. Heater is damaged, replace the heater
Material not extruding	Material is stuck in the extruder. See 3.3.3 Maintain (Extrude)
	The gap is too wide between the bearing and wire feed rollers.
Cannot communicate with printer	1. Make sure the USB cable is connected to the printer, and to the PC
	2. Unplug the USB cable, then plug in again.
	3. Reset the printer—power off then power on.
	4. Restart the PC
Others	Contact Technical Support : Support@pp3dp.com

Solution for "Winusb.dll not found" problem

If you encounter a "Winusb.dll not found" error message, please follow the steps below:

Option 1: Uninstall Older Driver and Automatically Install New Driver

1. Open the Windows control panel, go to the "System Properties" dialog box, then select the "Hardware" page.

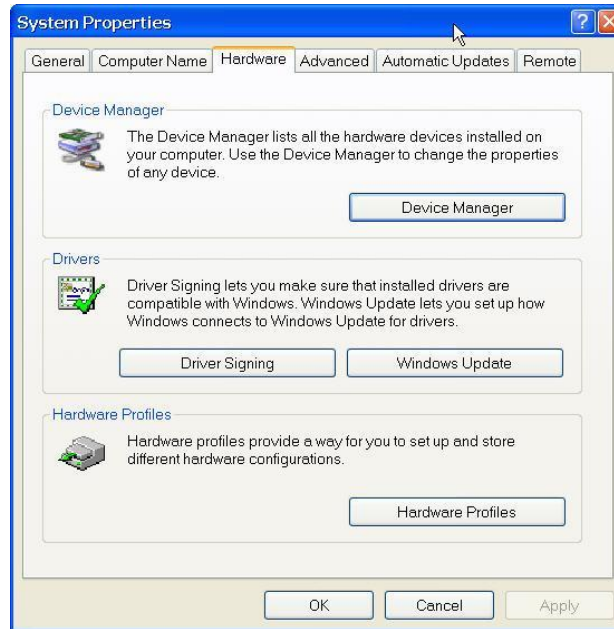

2. Click “Device Manager” button, and the following dialog box will popup. Find the “3DPrinter@FreeMC” in the USB section.



3. Click the right mouse button and select the “Uninstall” option. The confirm dialog box will appear. Click “OK”.

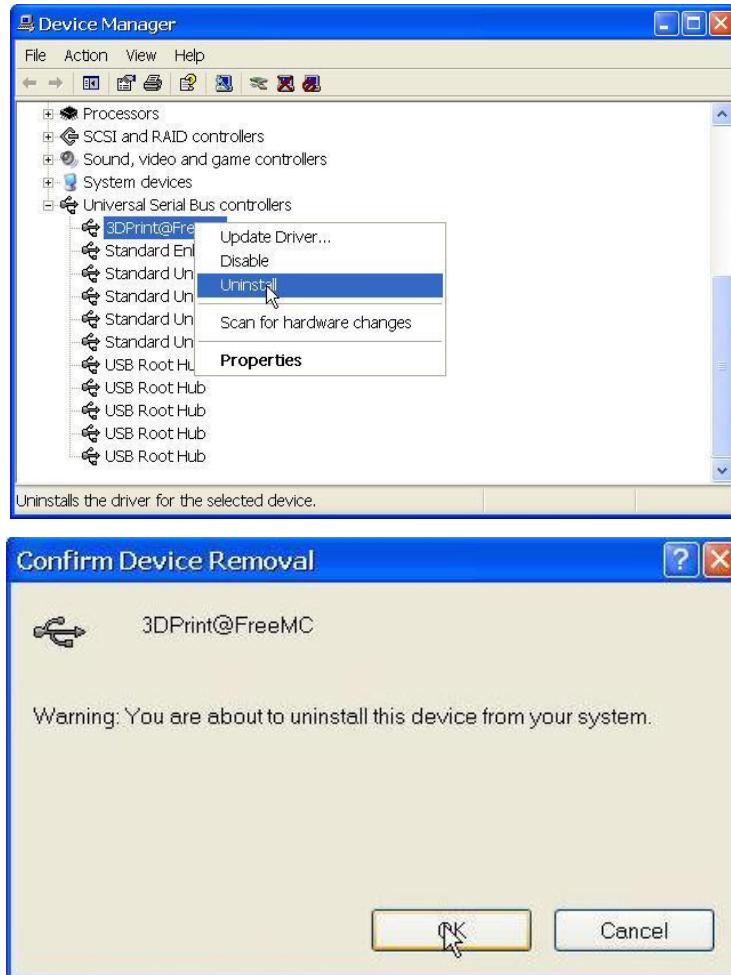

4. Install the latest UP! software.

5. Unplug the USB cable, then plug again. Windows will find a new device. Manually select driver folder (Default is C:\Program files\UP\Driver or C:\Program files(X86)\UP\Driver);

6. There should now be a new driver section in the device manager as shown below:

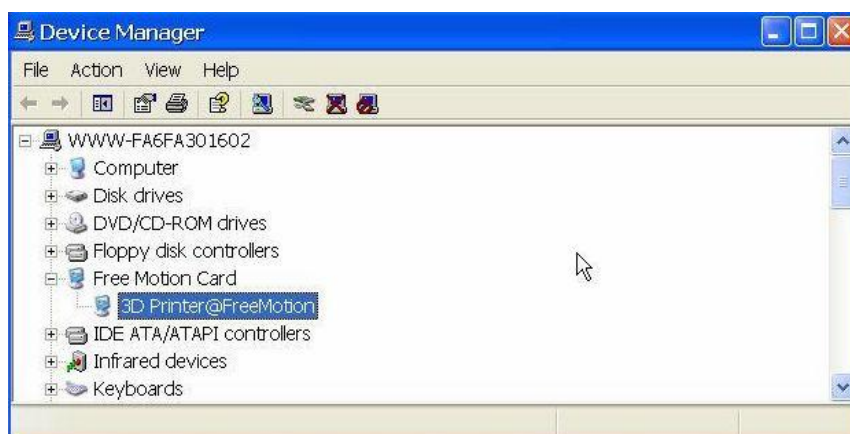

Option 2: Update the driver manually.

1. Install the latest UP software.
2. Find the “3DPrint@FreeMC” driver in the “Device Manager” dialog box (it should be located in the USB section).

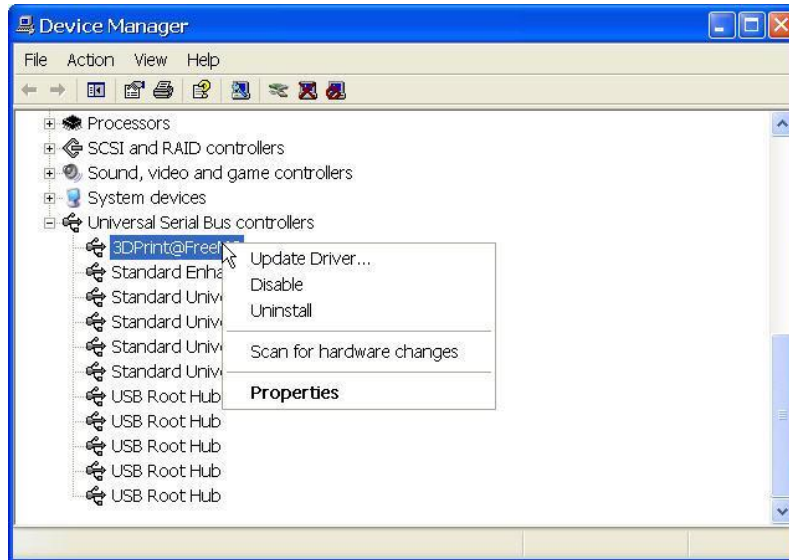

3. Select “Update Driver.” in the right click menu.

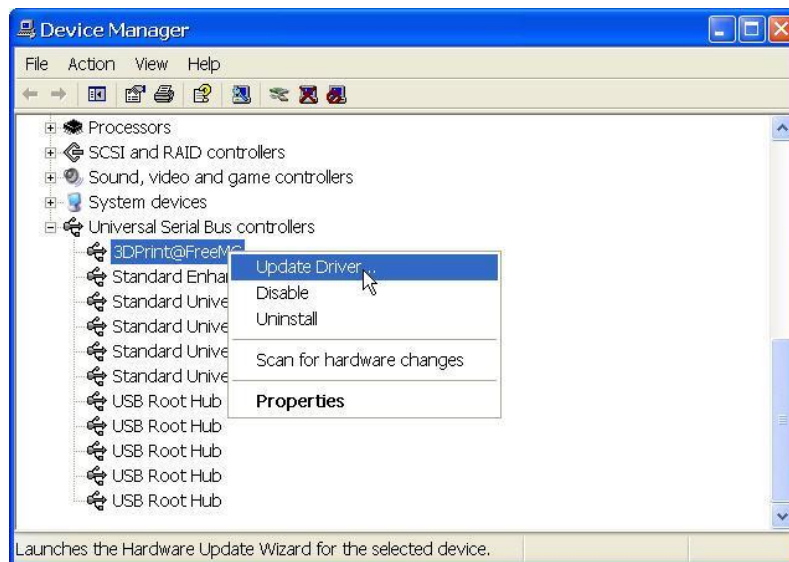

4. Select the up driver folder (the default is C:\program files\UP\Driver).

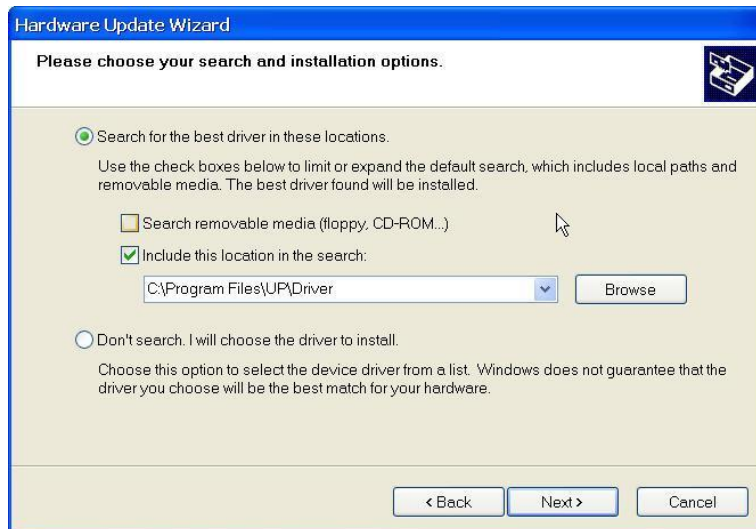

5. A “Free Motion Card” section should now have been inserted into the Device Manager.

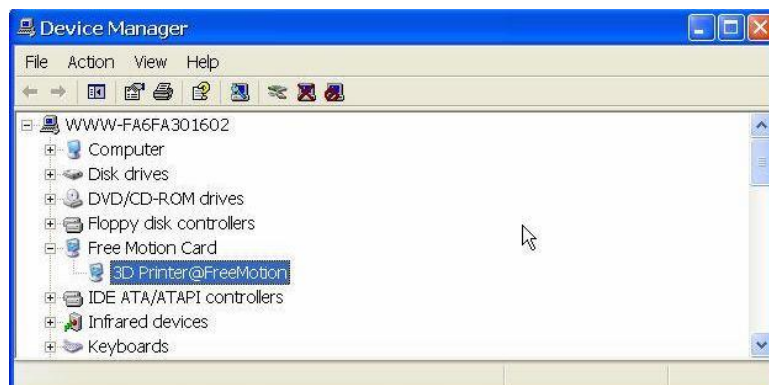



VOP CZ, s.p.
locality Vyškov
V. Nejedlého 691, 682 03 Vyškov, Czech Republic

CERTIFICATE
No VTÚPV – 137 / 2012 / SZ

Applicant: Delta Micro Factory Corporation
Rm 1008, Tower A, Third Property Building, No.1 Shuguang Xili,
Chaoyang District, Beijing, 100028, P.R.China

Product: UPI 3D Printer

Model: 3DP-14-4A, 3DP-14-4B, 3DP-14-4C, 3DP-10-4A, 3DP-16-4A

Manufacturer: Delta Micro Factory Corporation
Rm 1008, Tower A, Third Property Building, No.1 Shuguang Xili,
Chaoyang District, Beijing, 100028, P.R.China

Rating and principal characteristics: Voltage: 19 V DC; Current: 9.5 A;
Supply by Adaptor: Input: 100-240 V; 50-60 Hz; 2.25 A
Output: 19 V DC; 9.5 A

Test results are described in the Test Report No.:
STE120604691 (tests made by Shenzhen Certification Technology Service Co., Ltd.)
STS120604205 (tests made by Shenzhen Certification Technology Service Co., Ltd.)

The sample of tested product conforms with the requirements of the following standards harmonized with the EMC Directive No. 2004/103/EC and LVD Directive No. 2006/95/EC

- EN 55022: 2010
- EN 55024: 2010
- EN 60950-1: 2006+A11: 2009+A1: 2010
- EN 61000-3-2: 2006+A1: 2009+A2: 2009
- EN 61000-3-3: 2008

This certificate is valid until: 20. 06. 2015

After preparation of the necessary technical documentation as well as the conformity declaration, the required CE marking can be affixed on the product. Other relevant directives have to be observed.
The CE mark shall appear according to this sample:

CE

Vyškov 20. 06. 2012

Tel./Fax: +420 517 303 603
e-mail: bezdek.m@vop.cz
http://www.vop.cz

Milan Bezdek
Certification Head



Acknowledgements

PP3DP team is grateful for the wording and editing support from Prof. Olaf Diegel, and also grateful to Mr. Drew Petitcherc from the Up! Forum for providing the picture of his machine with Kapton tape.