



Specifications Approval Sheet

保管單位 Storage	產品應用工程部
保存年限 Retention Period	三年

Product Description: 20.1" COLOR TFT-LCD TV MODULE	
AUX Model Name: A201SN02 V5	
Customer Part No/Project Name:	
Customer Signature	AUO 2006/03/17
	Approved By: <i>Robert Chen</i>
	Reviewed By: <i>HS Huang</i>
	Prepared By: <i>Jerry Lee</i>

Please return one copy with your signature and comments for our confirmation.

AU Optronics Corporation

Tel: +886-3-563-2899

Fax: +886-3-563-1590

* No Reproduction and Redistribution Allowed



* No Reproduction and Redistribution Allowed

Spec. No.	TVPM A201SN02 V5
-----------	---------------------

Version : 5.03
Date : 03/17/2006

Product Specification

20.1" COLOR TFT-LCD MODULE

MODEL NAME: A201SN02 V.5

< > Preliminary Specification

< ◆ > Final Specification

Note: The content of this specification is subject to change.

© 2006 AU Optronics
All Rights Reserved,
Do Not Copy.

Record of Revision

Version	Revise Date	Old Description(A201SN02 V4)	New Description(A201SN02 V5)	Remark
5.03	17/Mar/2006	<p>A. Physical specifications</p> <p>7. Display Color: 16.7M / 8bit</p> <p>9. Color Gamut t: 75% NTSC</p> <p>B. Electrical specifications</p> <p>2. Absolute maximum ratings</p> <p>Input signal voltage: Max. Vcc+0.3</p> <p>3. Electrical characteristics</p> <p>a. Typical operating conditions</p> <p>Inrush current: Max. 1.5 A</p> <p>c. Input signal timing</p> <p>(1). Timing characteristics of input signals</p> <p>C. Optical specifications</p> <p>Contrast ratio: 500:1</p> <p>Viewing angle (L/R/T/B): 80/80/60/60</p> <p>Color Saturation (NTSC): 75%</p> <p>Fig. 1 2D Drawing</p> <p>BLU Cable Length: 140mm</p>	<p>A. Physical specifications</p> <p>7. Display Color: <u>16.2M / 6bit + FRC</u></p> <p>9. Contrast Ratio: <u>700:1</u></p> <p>10. Color Gamut t: <u>72% NTSC</u></p> <p>B. Electrical specifications</p> <p>2. Absolute maximum ratings</p> <p>Input signal voltage: <u>Max. 3.6 V</u></p> <p>3. Electrical characteristics</p> <p>a. Typical operating conditions</p> <p>Inrush current: <u>Max. 3.0 A</u></p> <p>c. Input signal timing</p> <p>(1). Timing characteristics of input signals</p> <p>Updated: <u>See Page 9.</u></p> <p>C. Optical specifications</p> <p>Contrast ratio: <u>700:1</u></p> <p>Viewing angle (L/R/T/B): <u>80/80/80/60</u></p> <p>Color Saturation (NTSC): <u>72%</u></p> <p>Color chromaticity (CIE): Updated</p> <p>Note 9: Definition of white uniformity</p> <p><u>Change from 13 points to 9points</u> (The same as all TV models)</p> <p>G. Packing</p> <p><u>Add Green Mark Description</u></p> <p>Fig. 1 2D updated exact drawing</p> <p>BLU Cable Length: 160mm</p>	

Contents:**A. Physical specifications****B. Electrical specifications**

1. Pin assignment.
2. Absolute maximum ratings
3. Electrical characteristics
 - a. Typical operating conditions.
 - b. Display color v. s. input data signals
 - c. Input signal timing
 - d. Display position
 - e. Backlight unit

C. Optical specifications**D. Reliability test items****E. Display quality****F. Handling precaution****G. Packing****Appendix:**

Fig.1 LCM outline dimensions

Fig.2 Timing chart

A. Physical specifications

NO.	Item	Specification	Remark
1	Display resolution(pixel)	800x3(H)x600(V)	
2	Display Mode	TN Type, Normally White + SWV Film	
3	Active area (mm)	408(H)x306(V)	
4	Screen size (inch)	20.1(Diagonal)	
5	Pixel pitch (mm)	0.51(H)x0.51(V)	
6	Color configuration	R. G. B. Vertical stripe	
7	Display Color	16.2M (6 bit + FRC)	
8	Typical white Luminance	450 nit (typ.)	
9	Contrast ratio	700:1	
10	Color Gamut	72% typ. of NTSC coverage	
11	Response Time	16ms typ. (Tr+Tf)	
12	Electrical Interface	TTL 1 port	
13	Overall dimension (mm)	448(W)x347(H)x23(D)(max.)	Note 1
14	Weight (g)	3500	
15	Surface Treatment	Anti-Glare type	
16	RoHS	RoHS compliance	

Note 1: Refer to Fig. 1.

B. Electrical specifications

1. Pin assignment

P/N	Symbol	Function		P/N	Symbol	Function
1	NC			26	R0	Red Data
2	NC			27	GND	Ground
3	NC			28	G7	Green Data
4	GND	Ground		29	G6	
5	GND	Ground		30	G5	
6	V _{CC}	Power Input (+5.0V)		31	G4	
7	V _{CC}			32	GND	Ground
8	V _{CC}			33	G3	Green Data
9	V _{CC}			34	G2	
10	GND		35	G1		
11	HSYNC	Horizontal Sync.	Active Low	36	G0	Ground
12	VSYNC	Vertical Sync.		37	GND	
13	GND			38	B7	Blue Data
14	DE	Data Enable		39	B6	
15	GND			40	B5	
16	DCLK	Dot Clock		41	B4	
17	GND	Ground		42	GND	Ground
18	R7	Red Data (R7 :MSB)		43	B3	Blue Data
19	R6			44	B2	
20	R5			45	B1	
21	R4			46	B0	
22	GND	Ground		47	GND	Ground
23	R3	Red Data		48	GND	Ground
24	R2			49	NC	
25	R1			50	NC	

CN1 (50P) connector: Compatible with P-Two AF7501-N2G1Z

2. Absolute maximum ratings

(GND = 0 V)

Parameter	Symbol	Values		Unit	Remark
		Min.	Max.		
Power voltage	V _{CC}	-0.3	5.5	V _{DC}	At 25°C
Input signal voltage	V _{LH}	-0.3	3.6	V _{DC}	At 25°C
Operating temperature	T _{OP}	0	+50	°C	Note 1
Storage temperature	T _{ST}	-20	+70	°C	Note 1

Note 1: The relative humidity must not exceed 90% *non-condensing* at temperatures of 40°C or less. At temperatures greater than 40°C, the wet bulb temperature must not exceed 39°C. When operate at low temperatures, the brightness of CCFL will drop and the lifetime of CCFL will be reduced.

Note 2: The unit should not be exposed to corrosive chemicals.

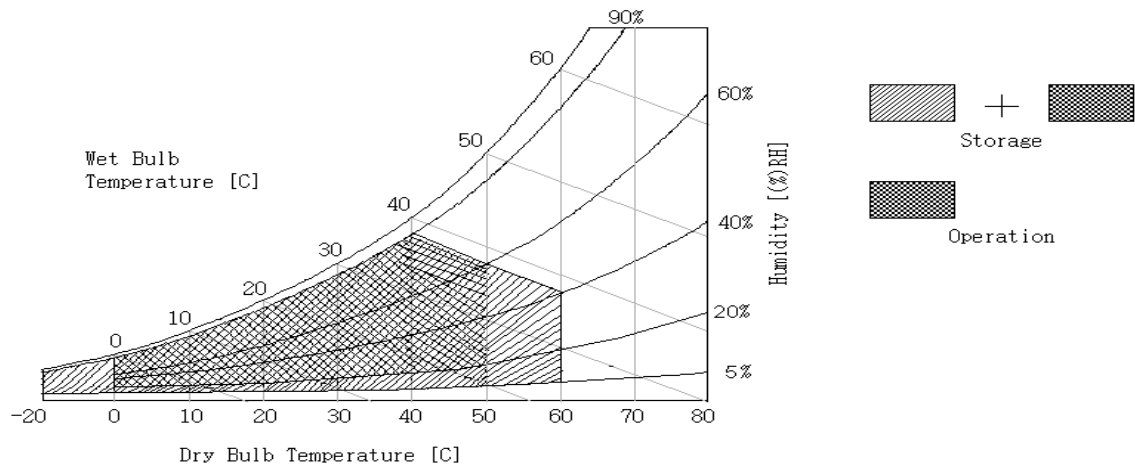

3. Electrical characteristics

a. Typical operating conditions

	Item	Symbol	Min.	Typ.	Max.	Unit	Remark
Power supply voltage	Input voltage	V_{CC}	4.75	5.0	5.25	V	
	Current consumption	I_A	-	0.8	1.0	Arms	Note 1
	Inrush current	I_{RUSH}	-	-	3.0	Apeak	Note 2
	Power ripple voltage	V_{RP}	-	-	100	mVp-p	
Internal logic	Low voltage	V_{IL}	0	-	1.0	V	
	High voltage	V_{IH}	2.3	-	3.3	V	

Note 1: Effective value (mArms) at $V_{CC} = 5\text{ V}/25^\circ\text{C}$.

Note 2: Refer to the following power-on condition.

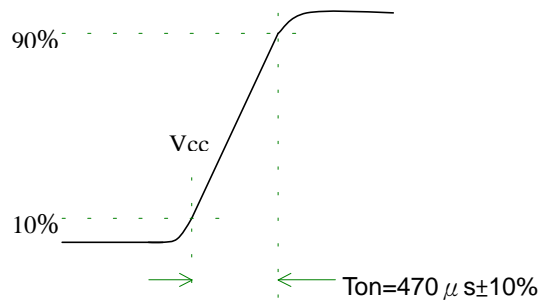

Sequence of Power-on/off and signal-on/off

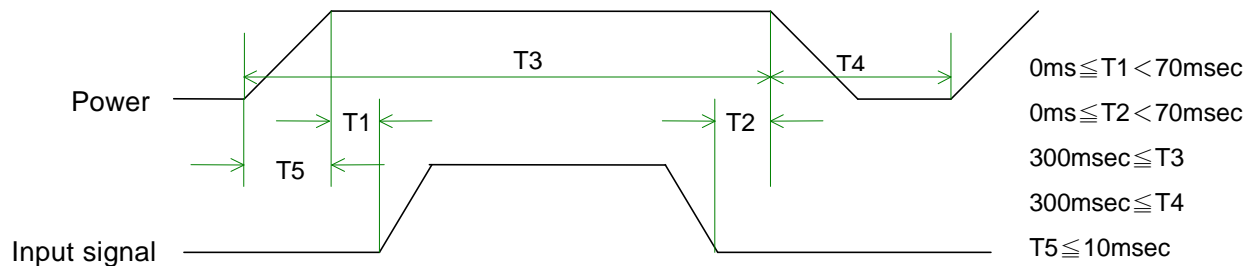

Apply the lamp voltage within the LCD operating range. When the backlight turns on before the LCD operation or the LCD turns off before the backlight turns off, the display may momentarily become abnormal.

Caution

The above on/off sequence should be applied to avoid abnormal function in the display.

In case of handling:

Make sure to turn off the power when you plug the cable into the input connector or pull the cable out of the connector.

b. Display color v.s. input data signals

Display colors		Data signal (0 : Low level, 1: High level)																							
		R7	R6	R5	R4	R3	R2	R1	R0	G7	G6	G5	G4	G3	G2	G1	G0	B7	B6	B5	B4	B3	B2	B1	B0
Basic colors	Black	0	0	0	0	0	0	0	0	0	0	0	0	0	0	0	0	0	0	0	0	0	0	0	0
	Blue	0	0	0	0	0	0	0	0	0	0	0	0	0	0	0	0	1	1	1	1	1	1	1	1
	Red	1	1	1	1	1	1	1	1	0	0	0	0	0	0	0	0	0	0	0	0	0	0	0	0
	Magenta	1	1	1	1	1	1	1	1	0	0	0	0	0	0	0	0	1	1	1	1	1	1	1	1
	Green	0	0	0	0	0	0	0	0	1	1	1	1	1	1	1	1	0	0	0	0	0	0	0	0
	Cyan	0	0	0	0	0	0	0	0	1	1	1	1	1	1	1	1	1	1	1	1	1	1	1	1
	Yellow	1	1	1	1	1	1	1	1	1	1	1	1	1	1	1	1	0	0	0	0	0	0	0	0
	White	1	1	1	1	1	1	1	1	1	1	1	1	1	1	1	1	1	1	1	1	1	1	1	1
Red grayscale	Black	0	0	0	0	0	0	0	0	0	0	0	0	0	0	0	0	0	0	0	0	0	0	0	0
	Dark	0	0	0	0	0	0	0	1	0	0	0	0	0	0	0	0	0	0	0	0	0	0	0	0
	↑																								
	↓																								
	bright	1	1	1	1	1	1	0	1	0	0	0	0	0	0	0	0	0	0	0	0	0	0	0	0
	Red	1	1	1	1	1	1	1	0	0	0	0	0	0	0	0	0	0	0	0	0	0	0	0	0
Green grayscale	Black	0	0	0	0	0	0	0	0	0	0	0	0	0	0	0	0	0	0	0	0	0	0	0	0
	Dark	0	0	0	0	0	0	0	0	0	0	0	0	0	0	0	1	0	0	0	0	0	0	0	0
	↑																								
	↓																								
	bright	0	0	0	0	0	0	0	0	1	1	1	1	1	1	0	1	0	0	0	0	0	0	0	0
	Green	0	0	0	0	0	0	0	0	1	1	1	1	1	1	1	1	0	0	0	0	0	0	0	0
Blue grayscale	Black	0	0	0	0	0	0	0	0	0	0	0	0	0	0	0	0	0	0	0	0	0	0	0	0
	Dark	0	0	0	0	0	0	0	0	0	0	0	0	0	0	0	0	0	0	0	0	0	0	0	1
	↑																								
	↓																								
	bright	0	0	0	0	0	0	0	0	0	0	0	0	0	0	0	0	1	1	1	1	1	1	0	1
	Blue	0	0	0	0	0	0	0	0	0	0	0	0	0	0	0	0	1	1	1	1	1	1	1	0

Note: Each basic color can be displayed in 256 gray scales using the 8 bit data signals. By combining the 24-bit data signals(R, G, B), the 16777216 colors can be achieved on the display.

ALL RIGHTS STRICTLY RESERVED. ANY PORTION OF THIS PAPER SHALL NOT BE REPRODUCED, COPIED, OR TRANSFORMED TO ANY OTHER FORMS WITHOUT PERMISSION FROM UNIPAC OPTOELECTRONICS CORP.

c. Input signal timing

Timing diagrams of input signal are shown in Fig 2.

(1). Timing characteristics of input signals

DE mode

Item	Symbol	Min.	Typ.	Max.	Unit	Remark
Clock frequency	Fck	38	40	50	MHz	
Horizontal blanking	Thb1	235	256	500	Clk	
Horizontal display period	Thd	-	800	-	Clk	
Horizontal sync. period	Th	1035	1056	1300	Clk	
Vertical frequency	-	46	60	76	Hz	
Vertical blanking	Tvb1	20	28	150	Th	
Vertical display width	Tvd	-	600	-	Th	
Vertical sync. period	Tv	620	628	750	Th	

H/V mode

Item	Symbol	Min.	Typ.	Max.	Unit	Remark
Clock frequency	Fck	38	40	50	MHz	
Horizontal display period	Thd	1030	1056	1060	Clk	
Hsync front porch	Thf	184	210	214	Clk	
Hsync width+back porch	Thw+Thb	46	46	46	Clk	
Hsync blanking	Thb1	230	256	260	Clk	
Vsync period	Tv	628	628	628	Th	
Vsync front porch	Tvf	1	1	1	Th	
Vsync blanking	Tvb1	28	28	28	Th	

Item	Symbol	Value	Unit	Description
Horizontal display start	The	46	Clk	After falling edge of Hsync, counting 46 clk, then getting valid data from 47th clk's data.
Vertical display start	Tve	27	Th	After falling edge of Vsync, counting 27Th, then getting 28th Th's data.

Note 1:Clock falling edge latch the data.

Note 2:H/V is negative polarity.

d. Display position

D(1,1)	D(2,1)	D(X,1)	D(799,1)	D(800,1)
D(1,2)	D(2,2)	D(X,2)	D(799,2)	D(800,2)
⋮		⋮	⋮	⋮
D(1,Y)	D(2,Y)	D(X,Y)	D(799,Y)	D(800,Y)
⋮		⋮	⋮	⋮
D(1,599)	D(2,599)	D(X,599)	D(799,599)	D(800,599)
D(1,600)	D(2,600)	D(X,600)	D(799,600)	D(800,600)

ALL RIGHTS STRICTLY RESERVED. ANY PORTION OF THIS PAPER SHALL NOT BE REPRODUCED, COPIED, OR TRANSFORMED TO ANY OTHER FORMS WITHOUT PERMISSION FROM UNIPAC OPTOELECTRONICS CORP.

e. Backlight unit

The backlight system is an edge-lighting type with a CCFT(Cold Cathode Fluorescent Tube).

The characteristics of a single lamp are shown in the following tables.

Parameter	Symbol	Min.	Typ.	Max.	Unit	Remark
Lamp voltage	V_L	720	800	880	Vrms	Note 1
Lamp current	I_L	4	6.5	7	mArms	Note 1
Power consumption	P_L	-	5.2x6	-	W	Note 2
Lamp starting voltage	V_S	-	-	1500(T=0°C)	Vrms	Note 3
		-	-	1150(T=25°C)		
Frequency	F_L	40	52	60	KHz	Note 4
Lamp life time	L_L	50000	-	-	Hr	Note 1, 5

Note 1: T= 25°C

Note 2: Inverter should be designed with the characteristic of lamp. When you are designing the inverter, the output voltage of the inverter should comply with the following conditions.

- (1). The area under the positive and negative cycles of the waveform of the lamp current and lamp voltage should be area symmetric (the symmetric ratio should be larger than 90%).
- (2). There should not be any spikes in the waveform.
- (3). The waveform should be sine wave as possible.
- (4). Lamp current should not exceed the maximum value within the operating temperature (It is prohibited to over the maximum lamp current even if operated in the non-guaranteed temperature). When lamp current over the maximum value for a long time, it may cause fire. Therefore, it is recommend that the inverter should have the current limited circuit.

Note 3: The inverter open voltage should be designed larger than the lamp starting voltage at T=0°C, otherwise backlight may be blinking for a moment after turning on or not be able to turn on. The open voltage should be measured after ballast capacitor. If an inverter has shutdown function it should keep its open voltage for longer than 1 second even if lamp connector is open.

Note 4: Lamp frequency may produce interference with horizontal synchronous frequency and this may cause line flow on the display. Therefore lamp frequency shall be detached from the horizontal synchronous frequency and its harmonics as far as possible in order to avoid interference.

Note 5: Brightness ($I_L= 6.5mA$) to be decrease to the 50% of the initial value.

Note 6: CN2 connector (backlight): BHSR-02VS-1 (JST)

Mating connector: SM02B-BHS-1-TB (JST)

Pin no.	Symbol	Function	Remark
1	H	CCFL power supply (H.V.)	Cable color: Pink (central); Dark Gray others)
2	L	CCFL power supply (GND)	Cable color: White

C. Optical specifications (Note 1, Note 2)

Item	Symbol	Condition	Specification			Unit	Remark
			Min.	Typ.	Max.		
Response time Rising time Falling time	Tr Tf	$\theta = 0^\circ$	- -	11 5	15 10	ms	Note 5
Contrast ratio(center of screen)	CR	$\theta = 0^\circ$	600	700	-		Note 3,4,6
Viewing angle Top Bottom Left Right		$CR \geq 10$	65 55 65 65	80 60 80 80	- - - -	Deg.	Note 3,6,8
Brightness (center of screen)	Y_L	$\theta = 0^\circ$	350	450	-	nit	Note 4,7
Color chromaticity (CIE)	W_x	$\theta = 0^\circ$	0.249	0.279	0.309		Note 3
	W_y		0.260	0.290	0.320		
	R_x		0.607	0.637	0.667		
	R_y		0.311	0.341	0.371		
	G_x		0.268	0.298	0.328		
	G_y		0.568	0.598	0.628		
	B_x		0.113	0.143	0.173		
	B_y		0.028	0.058	0.088		
Color Saturation (NTSC)				72		%	
White uniformity	δ_w		70	-	-	%	Note 3,9

Note 1: Ambient temperature = 25°C.

Note 2: To be measured in dark room after backlight warm up 30 minutes.

Note 3: To be measured with a viewing cone of 1° by Topcon luminance meter ELDIM EZContrast 160D.

Note 4: To be measured with the detector PR880

Note 5: Definition of response time:

The output signals of BM-7 are measured when the input signals are changed from "Black" to "White" (falling time) and from "White" to "Black" (rising time), respectively. The response time interval between the 10% and 90% of amplitudes. Refer to figure as below.

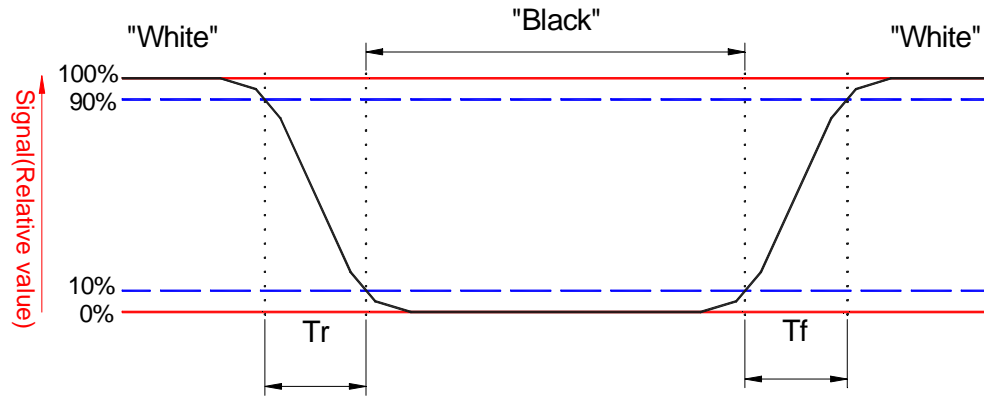

Note 6. Definition of contrast ratio:

Contrast ratio is calculated with the following formula.

$$\text{Contrast ratio (CR)} = \frac{\text{Brightness on the "white" state}}{\text{Brightness on the "black" state}}$$

Note 7: Driving conditions for CCFL: $I_L = 6.5 \text{ mA}$, 52KHz Frequency.

Note 8: Definition of viewing angle:

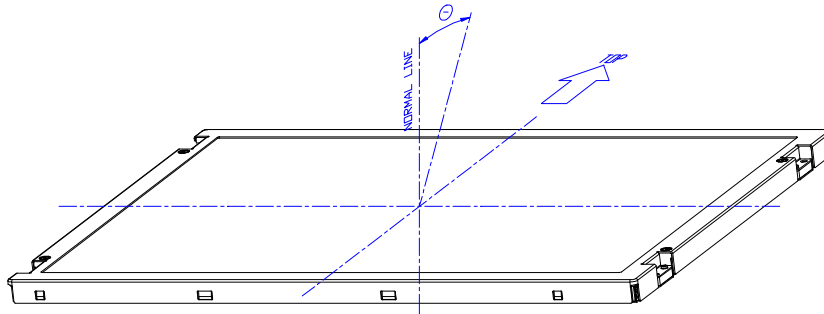

Note 9: Definition of white uniformity:

White uniformity is calculated with the following formula.

Luminance are measured at the following nine points (1~9).

$$\delta_w = \frac{\text{Minimum Brightness of 9 points}}{\text{Maximum Brightness of 9 points}}$$

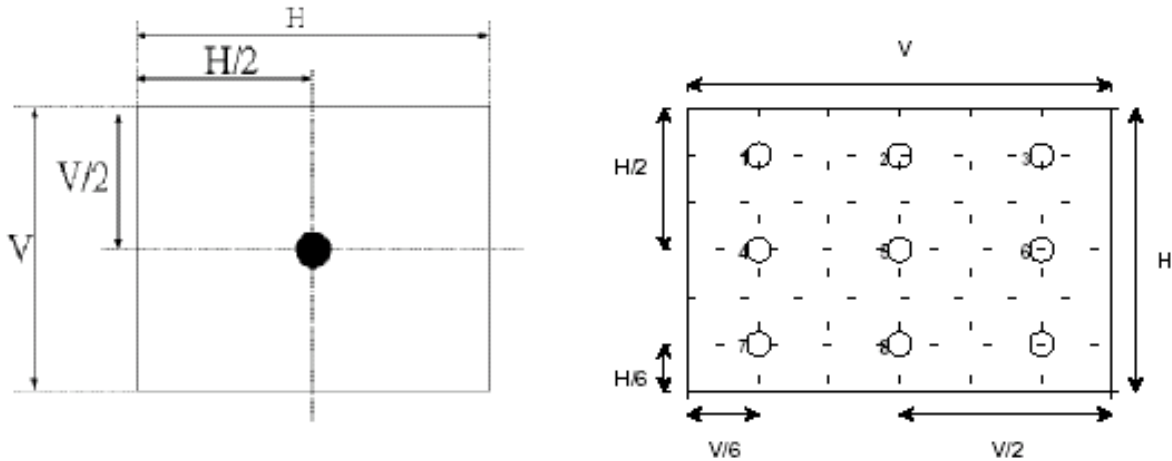

D. Reliability test items (Note 1)

Test tem	Test Condition	Remark
High temperature storage	60°C, 240Hrs	Note 1, 2, 3
Low temperature storage	-20°C, 240Hrs	Note 1, 2, 3
High temperature operation	50°C, 240Hrs	Note 1, 2, 3
Low temperature operation	0°C, 240Hrs	Note 1, 2, 3
Temperature cycling (non-operation)	-20°C~60°C 1H, 10mins, 1H, 5cycles	Note 1, 2, 3
Electrostatic discharge (non-operation)	150 pF, 150 Ω, 10kV, 1 second, 9 position on the panel, 10 times each place	Note 3
Vibration (non-operation)	Sweep: 1G, 10Hz ~ 500Hz ~ 10Hz/2.5min 2 hours for each direction X, Y, Z (6 Hrs in total)	Note 1, 2, 3
Mechanical shock (non-operation)	50G/11ms, 200G/2ms, ±X, ±Y, ±Z once for each direction	Note 1, 2, 3

Note 1: Evaluation should be tested after storage at room temperature for one hour.

Note 2: There should be no change which might affect the practical display function when the display quality test is conducted under normal operating condition.

Note 3: Judgment: Function OK.

E. Display quality

The display quality of the color TFT-LCD module should be in compliance with the AUO's OQC inspection standard.

F. Handling precaution

The Handling of the TFT-LCD should be in compliance with the AUO's handling principle standard.

G. Packing:
Label Sample



Green Mark Description:

For Pb Free products, AUO will add  for identification.

For RoHS compatible products, AUO will add  for identification.

Note. The Green Mark will be present only when the green documents have been ready by AUO Internal Green Team. (The definition of green design follows the AUO green design checklist.)

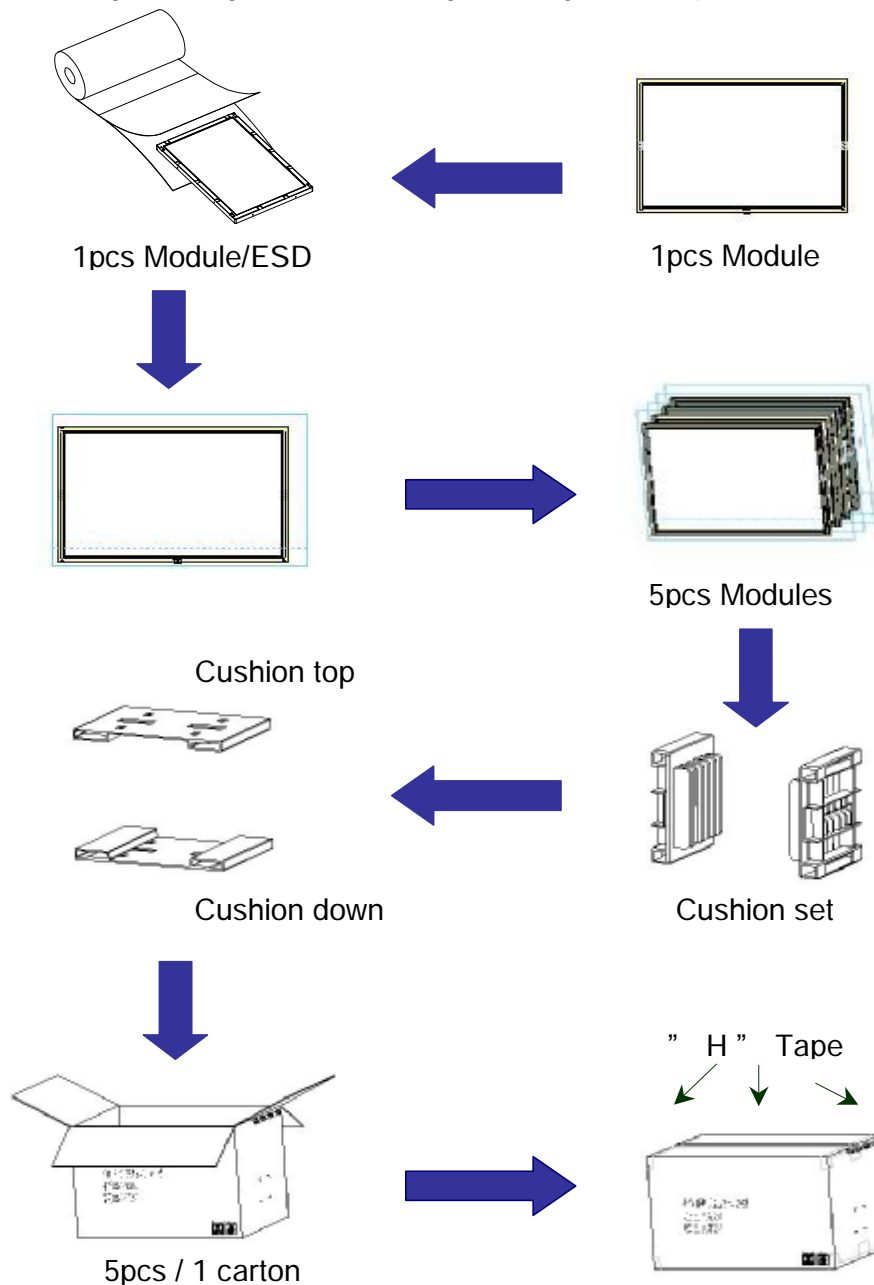

ALL RIGHTS STRICTLY RESERVED. ANY PORTION OF THIS PAPER SHALL NOT BE REPRODUCED, COPIED, OR TRANSFORMED TO ANY OTHER FORMS WITHOUT PERMISSION FROM UNIPAC OPTOELECTRONICS CORP.

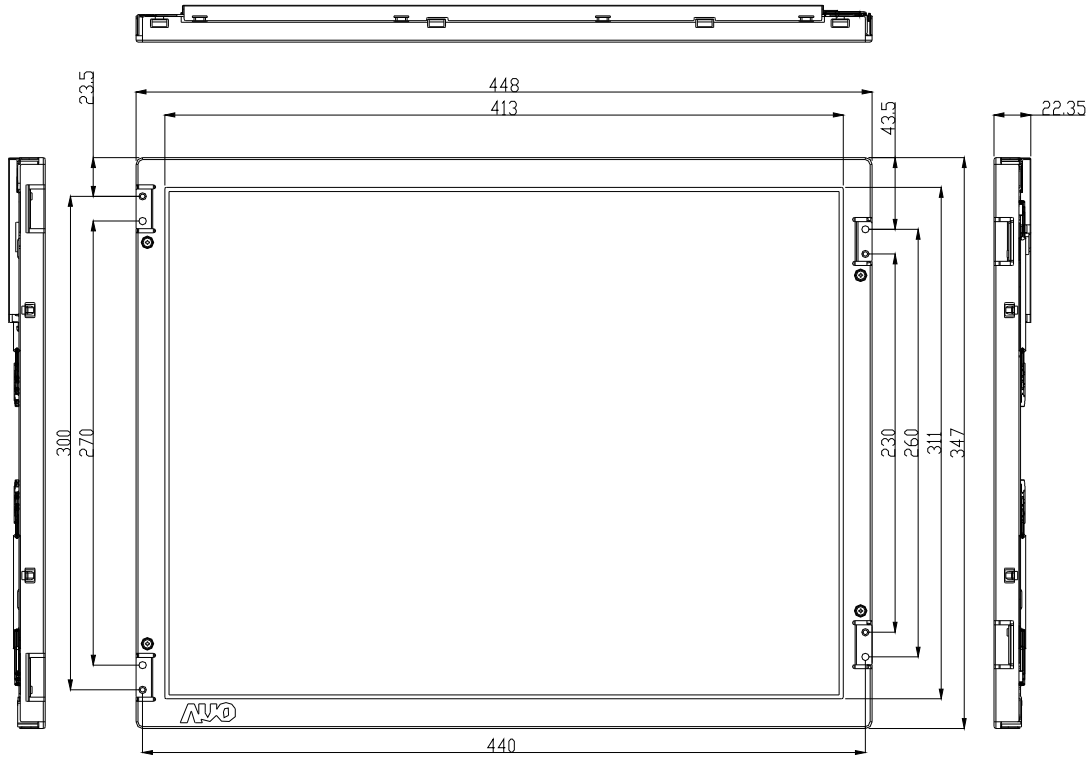

BLU Cable Length: 160mm

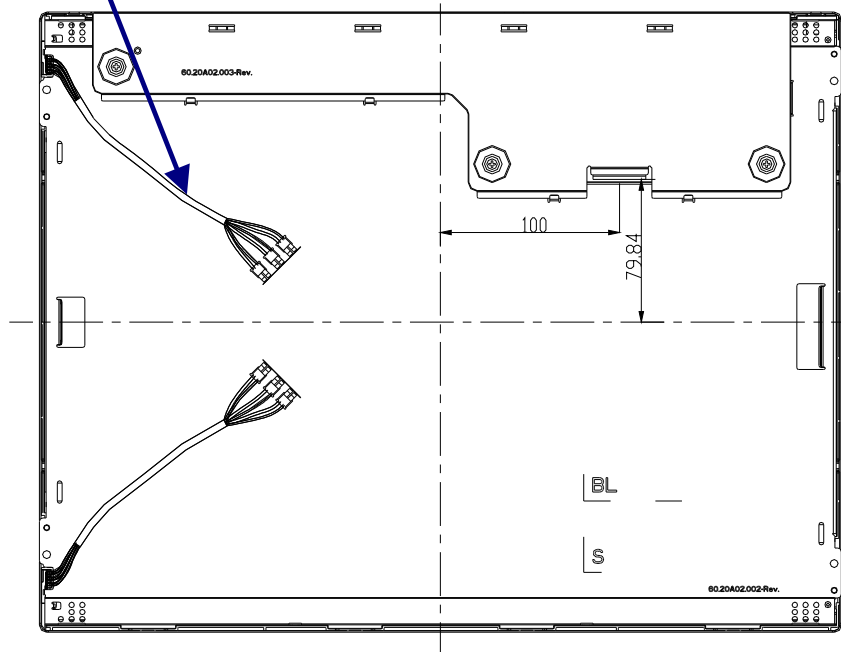

Fig.1 LCM outline dimension

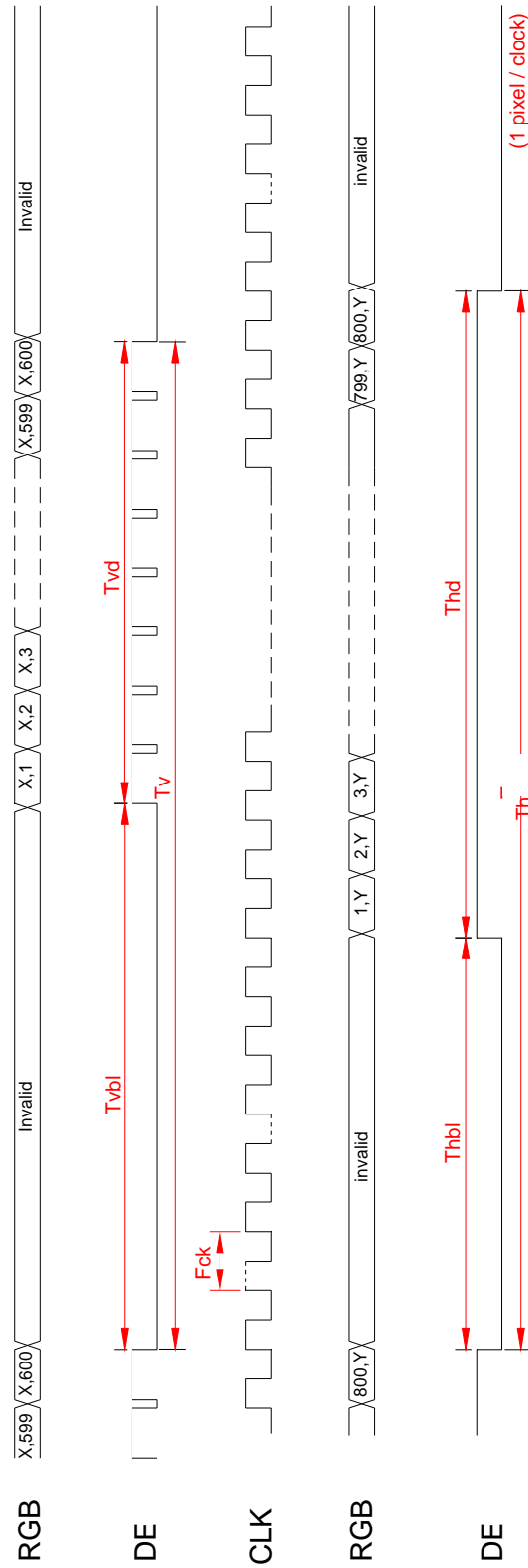

Fig.2 Timing chart