

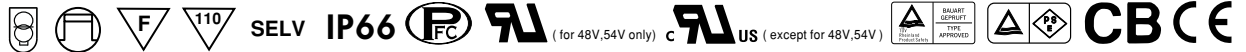

### ■ Features :

- Universal AC input / Full range (up to 295VAC)
- Protections: Short circuit / Over current / Over voltage / Over temperature
- Output voltage and constant current level adjustable
- Built-in active PFC function
- IP66 design for indoor or outdoor installations
- Class 2 power unit
- Cooling by free air convection
- 100% full load burn-in test
- High reliability
- Suitable for LED lighting and moving sign applications
- Compliance to worldwide safety regulations for lighting
- Suitable for dry / damp / wet locations
- 3 years warranty

### SPECIFICATION



MODEL		CEN-100-20	CEN-100-24	CEN-100-30	CEN-100-36	CEN-100-42	CEN-100-48	CEN-100-54	
OUTPUT	DC VOLTAGE	20V	24V	30V	36V	42V	48V	54V	
	CONSTANT CURRENT OPERATION VOLTAGE Note.5	13 ~ 20V	15.6 ~ 24V	19.5 ~ 30V	23.4 ~ 36V	27.3 ~ 42V	31.2 ~ 48V	35.1 ~ 54V	
	RATED CURRENT	4.8A	4A	3.2A	2.65A	2.28A	2A	1.77A	
	CURRENT RANGE	0 ~ 4.8A	0 ~ 4A	0 ~ 3.2A	0 ~ 2.65A	0 ~ 2.28A	0 ~ 2A	0 ~ 1.77A	
	RATED POWER	96W	96W	96W	95.4W	95.76W	96W	95.58W	
	RIPPLE & NOISE (max.) Note.2	2.0Vp-p	2.7Vp-p	3Vp-p	3.6Vp-p	4Vp-p	4.6Vp-p	5Vp-p	
	VOLTAGE ADJ. RANGE (SVR1)	17 ~ 22V	22 ~ 27V	27 ~ 33V	33 ~ 40V	37 ~ 46V	43 ~ 53V	49 ~ 58V	
	CURRENT ADJ. RANGE (SVR2)	3.12 ~ 4.8A	2.6 ~ 4A	2.08 ~ 3.2A	1.72 ~ 2.65A	1.48 ~ 2.28A	1.3 ~ 2A	1.15 ~ 1.77A	
	VOLTAGE TOLERANCE Note.3	±10%							
	LINE REGULATION	±3.0%							
LOAD REGULATION	±5.0%								
SETUP TIME	3000ms / 230VAC 5000ms / 115VAC at full load								
INPUT	VOLTAGE RANGE Note.4	90 ~ 295VAC	127 ~ 417VDC						
	FREQUENCY RANGE	47 ~ 63Hz							
	POWER FACTOR (Typ.)	PF>0.97/115VAC, PF>0.95/230VAC, PF>0.92/277VAC at full load (Please refer to "Power Factor Characteristic" curve)							
	EFFICIENCY (Typ.)	88%	89%	90%	90%	90%	91%	91%	
	AC CURRENT (Typ.)	1.4A/115VAC	0.7A/230VAC	0.5A/277VAC					
	INRUSH CURRENT (Typ.)	60A/230VAC							
	LEAKAGE CURRENT	<0.75mA / 240VAC							
PROTECTION	OVER CURRENT	95 ~ 110% Protection type : Constant current limiting, recovers automatically after fault condition is removed							
	SHORT CIRCUIT	Hiccup mode, recovers automatically after fault condition is removed							
	OVER VOLTAGE	22.8 ~ 26V	28 ~ 32V	34 ~ 38V	41 ~ 46V	47 ~ 52V	54 ~ 60V	59 ~ 65V	
	OVER TEMPERATURE	100°C ±10°C (RTH1) Protection type : Shut down o/p voltage, re-power on to recover							
ENVIRONMENT	WORKING TEMP.	-30 ~ +70°C (Refer to "Derating Curve")							
	WORKING HUMIDITY	20 ~ 95% RH non-condensing							
	STORAGE TEMP., HUMIDITY	-40 ~ +80°C, 10 ~ 95% RH							
	TEMP. COEFFICIENT	±0.03%/°C (0 ~ 50°C)							
	VIBRATION	10 ~ 500Hz, 5G 12min./1cycle, period for 72min. each along X, Y, Z axes							
SAFETY & EMC	SAFETY STANDARDS	UL8750, CSA C22.2 No. 250.0-08(except for 48V, 54V), TUV EN61347-1, EN61347-2-13, IP66, J61347-1, J61347-2-13 approved							
	WITHSTAND VOLTAGE	I/P-O/P:3.75KVAC I/P-FG:1.88KVAC O/P-FG:0.5KVAC							
	ISOLATION RESISTANCE	I/P-O/P, I/P-FG, O/P-FG: >100M Ohms / 500VDC / 25°C / 70% RH							
	EMC EMISSION	Compliance to EN55015, EN61000-3-2 Class C (≥65% load) ; EN61000-3-3							
	EMC IMMUNITY	Compliance to EN61000-4-2,3,4,5,6,8,11, EN55024, EN61547, light industry level (surge 4KV), criteria A							
OTHERS	MTBF	519.5Khrs min. MIL-HDBK-217F (25°C)							
	DIMENSION	195*62.5*40.5mm (L*W*H)							
	PACKING	0.6Kg; 24pcs/15.4Kg/1.11CUFT							
NOTE	<ol style="list-style-type: none"> <li>1. All parameters NOT specially mentioned are measured at 230VAC input, rated load and 25°C of ambient temperature.</li> <li>2. Ripple &amp; noise are measured at 20MHz of bandwidth by using a 12" twisted pair-wire terminated with a 0.1uf &amp; 47uf parallel capacitor.</li> <li>3. Tolerance : includes set up tolerance, line regulation and load regulation.</li> <li>4. Derating may be needed under low input voltage. Please check the static characteristics for more details.</li> <li>5. Constant current operation region is within 65% ~100% rated output voltage. This is the suitable operation region for LED related applications, but please reconfirm special electrical requirements for some specific system design.</li> <li>6. The power supply is considered as a component that will be operated in combination with final equipment. Since EMC performance will be affected by the complete installation, the final equipment manufacturers must re-qualify EMC Directive on the complete installation again.</li> <li>7. Direct connecting to LEDs is suggested, but is not suitable for using additional drivers.</li> </ol>								

**Mechanical Specification**

Case No. 993A Unit:mm

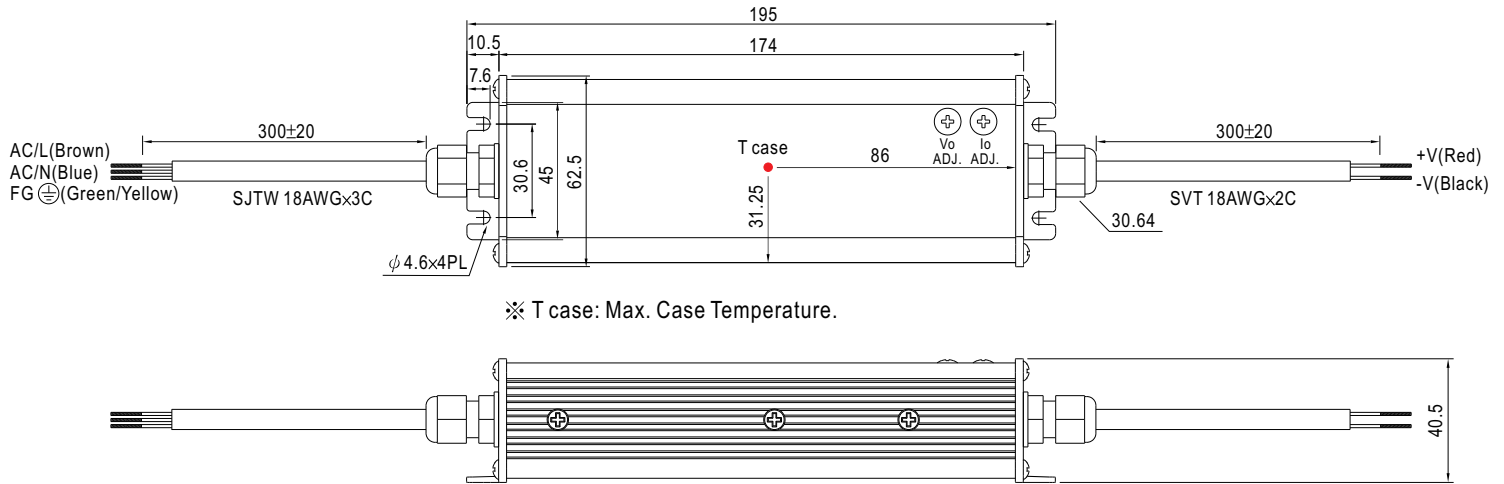

**Block Diagram**

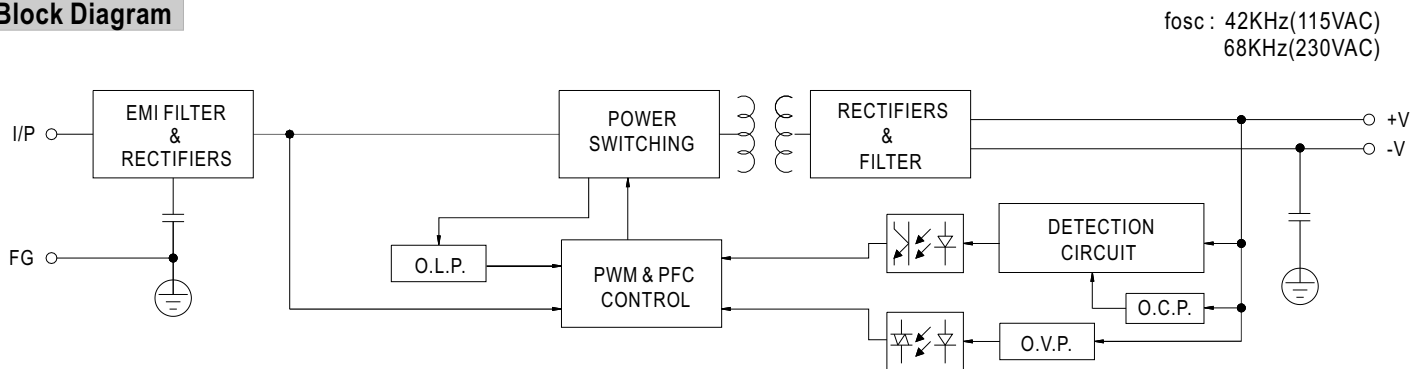

**Derating Curve**

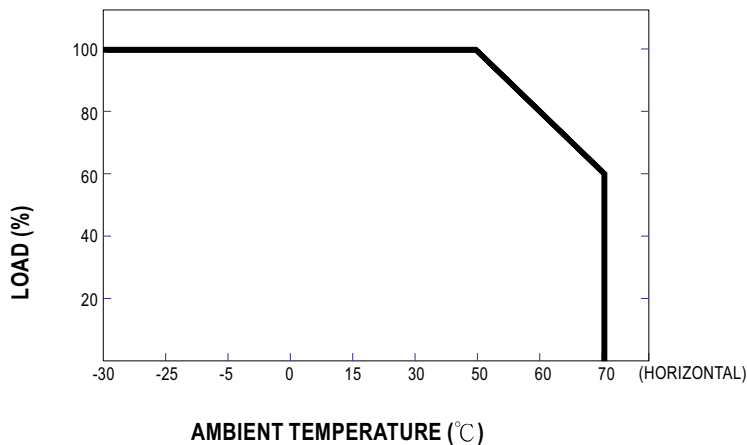

**Static Characteristics**

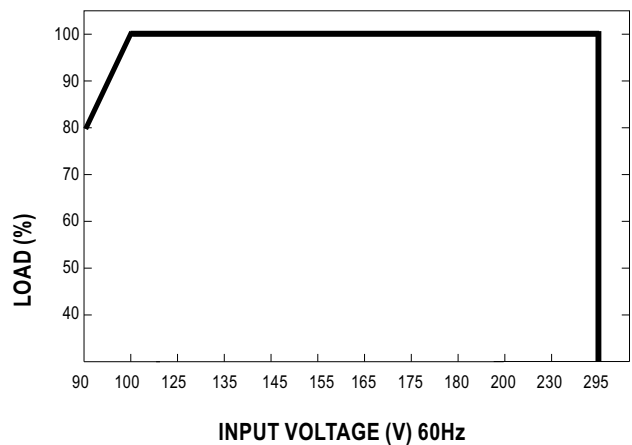

**Power Factor Characteristic**

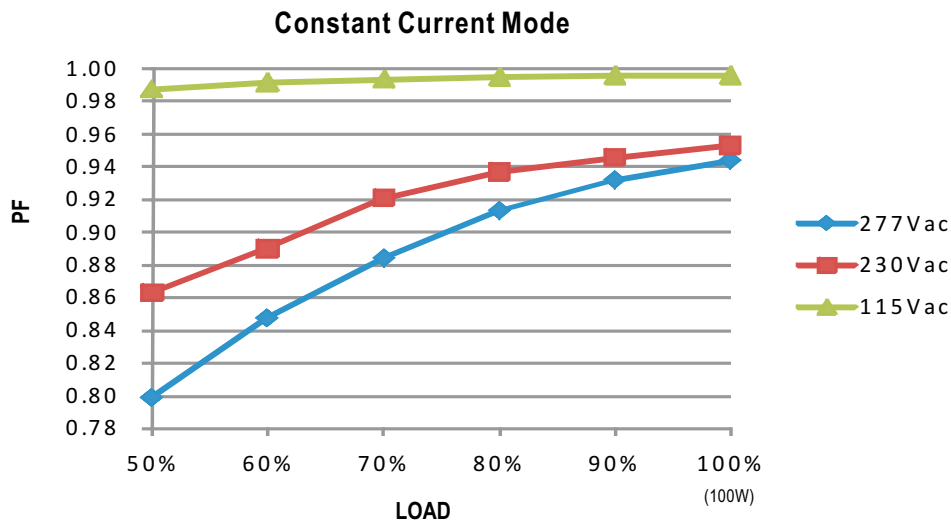

**EFFICIENCY vs LOAD (48V Model)**

CEN-100 series possess superior working efficiency that up to 91% can be reached in field applications.

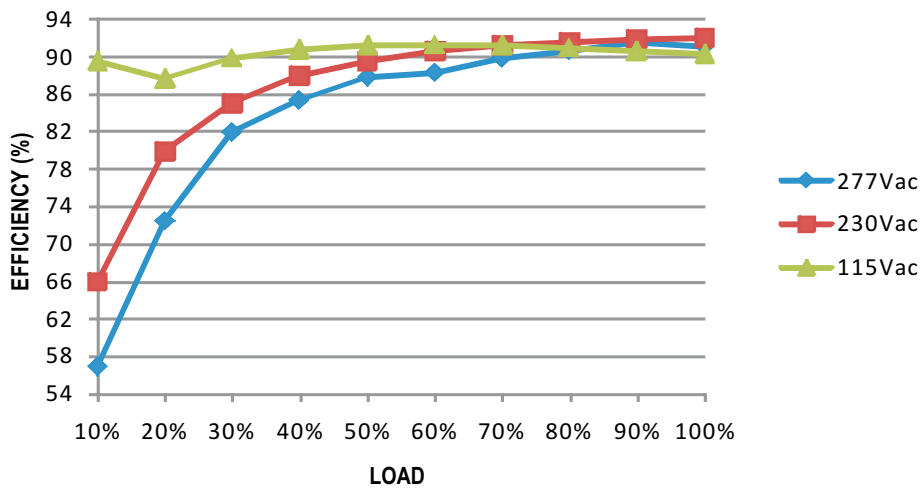

**DRIVING METHODS OF LED MODULE**

This LED power supply is suggested to work in constant current mode area (CC) to drive the LEDs.

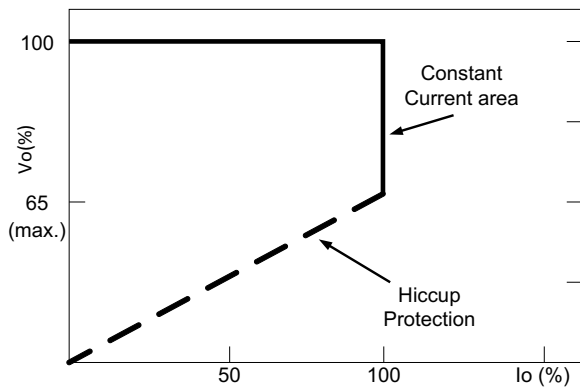

Typical LED power supply I-V curve