

SPECIFICATION
MODEL : SPMWHT5225D5WAQ0S0

Approved rank :
V_F(A1, A2, A3, A4, A5), CIE(P1, P2, P3, P4, P5, P6, P7, P8),
I_v(S1, S2)



5630 CRI80 WHITE LED Q0 RANK

CUSTOMER :	
CHECKED	APPROVED

SAMSUNG LED			
DRAWN	CHECKED		APPROVED
	SALES	QUALITY	

SAMSUNG LED CO., LTD.
314. MAETAN 3-DONG, YEONGTONG-GU,
SUWON-SI, GYEONGGI-DO, KOREA, 443-743

Contents

1.	Product Outline -----	3
2.	Absolute Maximum Rating -----	3
3.	Characteristics -----	3
4.	Chromaticity Diagram -----	4
5.	Typical Characteristic Graph -----	5
6.	Outline Drawing & Dimension -----	6
7.	Reliability Test Items & Conditions -----	7
8.	Solder Conditions -----	8
9.	Taping Dimension -----	9
10.	Label Structure -----	10
11.	Lot Number -----	10
12.	Reel Packing Structure -----	11
13.	Aluminum Packing Bag -----	12
14.	Precaution For Use -----	13
15.	Hazard Substance Analysis (SGS) -----	15
16.	Hazard Substance Analysis (SVHC) -----	22
17.	Revision History -----	30

1. Product Outline

1) Feature

- . Lead Frame Type LED Package (5.6 * 3.0 * t 0.95 mm)
- . Beam Angle ($\Delta\theta$: 120°)
- . GaN/Al₂O₃ Chip & Long Time Reliability

2) Applications

- . Indoor, Outdoor Display and etc.

2. Absolute Maximum Rating

Parameter	Symbol	Rating	Condition
Operating temperature range	T _{op}	-40 ~ +85 °C	
Storage temperature range	T _{stg}	-40 ~ +100 °C	
Junction Temperature	T _j	110 °C	
Forward current	I _F	150 mA	
Peak Pulsed Forward Current	I _{FP}	300 mA	Duty 1/10 Pulse Width 10 ms
Reverse Voltage	V _R	0.7 ~ 1.2 V	IR = 5 mA
Thermal resistance, Junction to PCB	R _{th, JS}	< 40 K/W	
Assembly Process Temp.		260 °C, < 10 sec	
ESD		5 kV	HBM

3. Characteristics

Electrical / Optical Characteristics

(Ta : 25 °C)

Item	Symbol	Conditions	Rank	Min.	Typ.	Max.	Unit	
Forward Voltage (*)	V _F	I _F = 50 mA	WA	A1	2.8	-	2.9	V
				A2	2.9	-	3.0	
				A3	3.0	-	3.1	
				A4	3.1	-	3.2	
				A5	3.2	-	3.3	
Reverse Voltage	V _r	I _F = 5 mA	-	0.7	-	1.2	V	
Color Rendering	R _a	I _F = 50 mA	5	80	-	-	-	

Luminous Intensity / Luminous Flux

(Ta : 25 °C)

Symbol	Conditions	Model Name	Rank	Min.	Typ.	Max.	Unit	
I _v	I _F = 50 mA	SPMWHT5225D5WAQ0S0	S0	S1	5.15	-	5.94	cd
				S2	5.94	-	6.93	
Φ _v	I _F = 50 mA	SPMWHT5225D5WAQ0S0	S0	S1	15.39	-	17.76	lm
				S2	17.76	-	20.72	

* Luminous Flux (Φ_v) : Only reference data.

Chromaticity Coordinate

(Ta : 25 °C)

Condition	Rank	x				y				
		I _F = 50 mA	Q0	Q1	0.3222	0.3290	0.3290	0.3215	0.3243	0.3300
Q2	0.3290			0.3366	0.3371	0.3290	0.3300	0.3369	0.3490	0.3417
Q3	0.3215			0.3290	0.3290	0.3206	0.3350	0.3417	0.3538	0.3461
Q4	0.3290			0.3371	0.3376	0.3290	0.3417	0.3490	0.3616	0.3538
Q5	0.3231			0.3290	0.3290	0.3222	0.3120	0.3180	0.3300	0.3243
Q6	0.3290			0.3361	0.3366	0.3290	0.3180	0.3245	0.3369	0.3300
Q7	0.3207			0.3290	0.3290	0.3196	0.3462	0.3538	0.3690	0.3602
Q8	0.3290			0.3376	0.3381	0.3290	0.3538	0.3616	0.3762	0.3690

- * Tolerance : V_F:±0.1 V, I_v:±5 %, x,y:±0.01, R_a :±3.0
- * Luminous Intensity measuring equipment : CAS140CT

4. Chromaticity Diagram

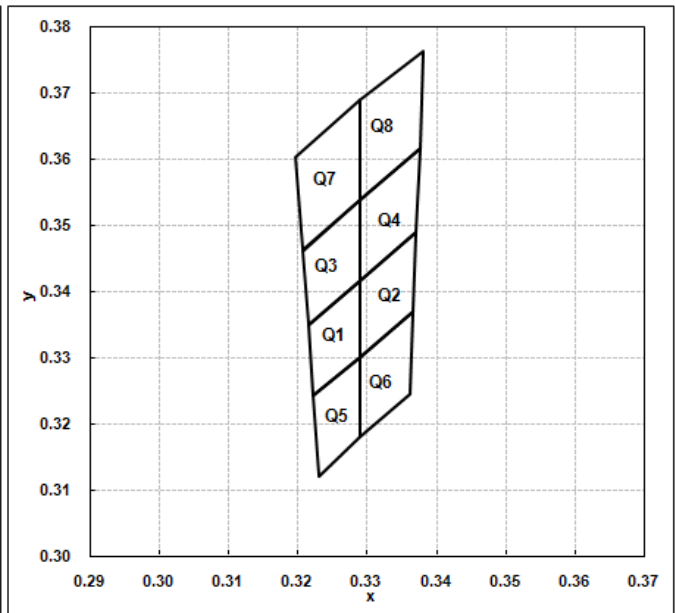
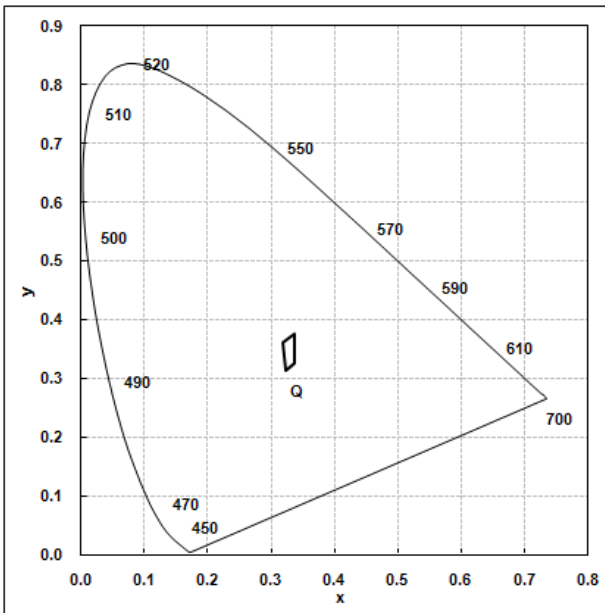

* Q0 = Q1+Q2+Q3+Q4+Q5+Q6+Q7+Q8

V _F	CIE	I _v
A1, A2, A3, A4, A5	Q1, Q2, Q3, Q4, Q5, Q6, Q7, Q8	S1, S2

- * Each reel contains only one of the A1, A2, A3, A4 or A5 a segment (1/5) of the V_F rank.
- * Each reel contains only one of the Q1, Q2, Q3, Q4, Q5, Q6, Q7 or Q8 a segment (1/8) of the CIE rank.
- * Each reel contains only one of the S1 or S2 a segment (1/2) of the I_v rank.

5. Typical Characteristics Graph

* These graphs show typical values.

(Ta : 25 °C)

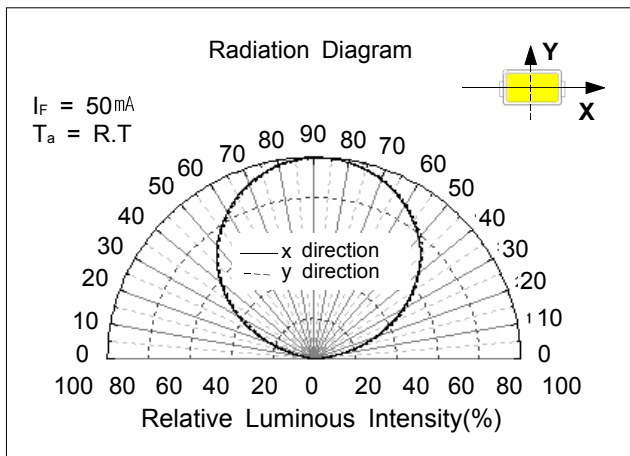
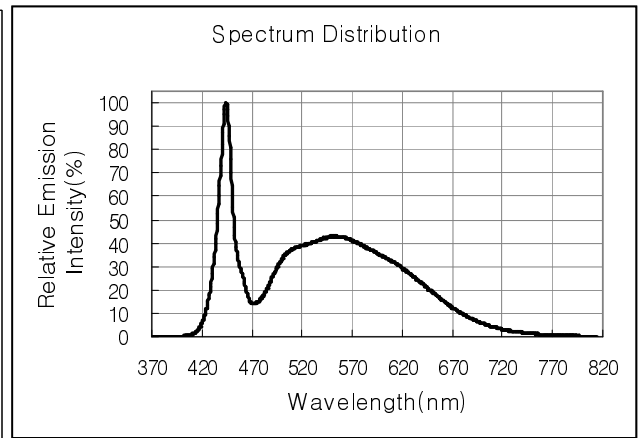
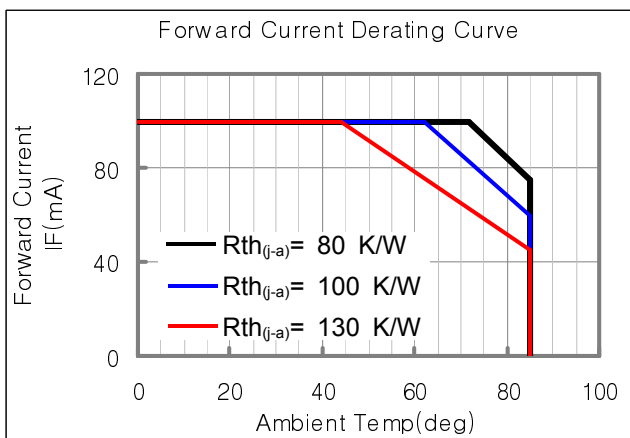
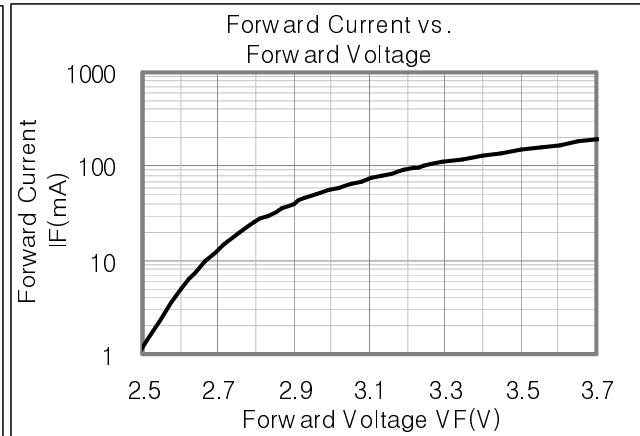
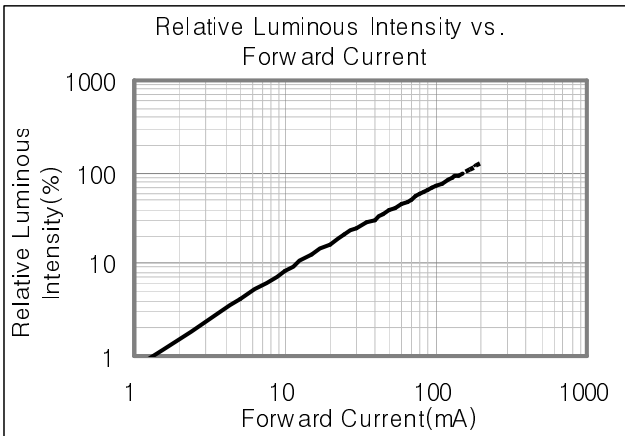

6. LED Package Outline Dimensions

unit:mm

Tolerance:±0.1

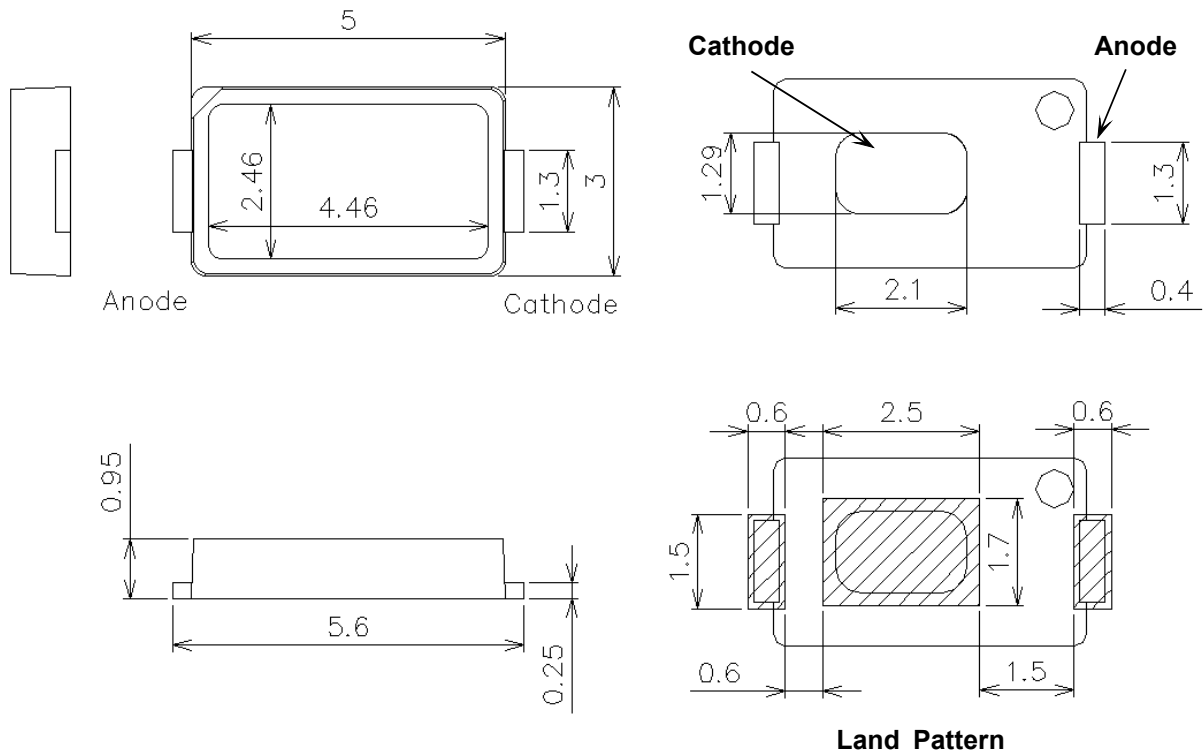

* This LED has built-in ESD protection device(s) connected in parallel to LED chip(s).

7. Reliability Test Items and Conditions

1) Test Items

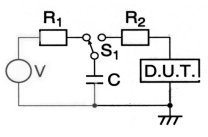
Test Item	Test Conditions	Test Hours/Cycles	Sample No	
MSL Test	125 °C 24hrs drying → 60 °C, 60 %RH 120hrs → 260 °C 10sec 3 cycles	1 cycle	50	
Room Temperature life test	25 °C±3 °C, DC100 mA	1,000 hrs	50	
High Temperature life test	85 °C±3 °C, DC75 mA	1,000 hrs	50	
High Temperature humidity life test	60 °C±3 °C, 95 %±2 %RH, DC100 mA	1,000 hrs	50	
High Temperature humidity On/Off test	85 °C±3 °C, 85 %±2 %RH, DC100 mA DC100 mA, On/2 sec, Off/5 sec	100,000 cycles	50	
Low Temperature life test	-40 °C±3 °C, DC100 mA	1,000 hrs	50	
Temperature humidity Cycle	-10 °C ~ 25 °C, 95 %RH ~ 65 °C, 95 %RH DC100 mA, 24 hrs/1 cycle	10 cycles	50	
Thermal Shock	-45 °C/15 min ↔ 125 °C/15 min, 150 Cycle => Reflow 260 °C → Hot plate 180 °C	1 cycle	100	
High Temperature Storage	Ta=100 °C±3 °C	1000 hrs	11	
Low Temperature Storage	Ta=-40 °C±3 °C	1000 hrs	11	
Temperature humidity Cycle	-10 °C ~ 25 °C, 95 %RH ~ 65 °C, 95 %RH 24 hrs/ 1 cycle	10 cycles	11	
ESD(HBM)		R1:10 MΩ, R2:1.5 kΩ, C:100 pF, V = ±5 kV	5 times	5
ESD(MM)		-R1:10 MΩ, R2:0, C:200 pF, V = ±0.2 kV	5 times	5
Vibration Test	100~2000~100 Hz, 200 m/s ² , Sweep 4 min, 48 min, X, Y, Z 3 direction, each 1 cycle	4 cycles	11	
Mechanical Shock Test	1500G, 0.5 ms, 3 shocks each X-Y-Z axis	5 cycles	11	

2) Criteria for Judging the Damage

Item	Symbol	Test Condition	Limit	
			Min	Max
Forward Voltage	V_F	$I_F = 50 \text{ mA}$	Init. Value*0.9	Init. Value*1.1
Luminous Intensity	I_V	$I_F = 50 \text{ mA}$	Init. Value*0.8	Init. Value*1.2

* USL : Upper Standard Level LSL : Lower Standard Level

8. Solder Conditions

1) Reflow Conditions (Pb Free)

Reflow Frequency : 2 times max.

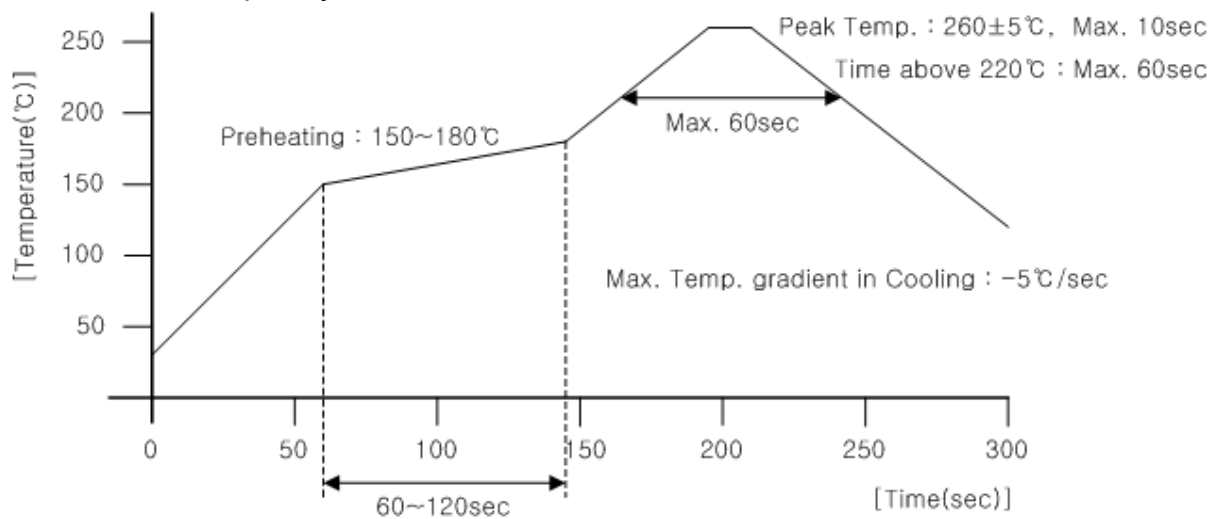

2) For Manual Soldering

Not more than 5 seconds @MAX300 °C, under soldering iron.

9. Taping Dimension

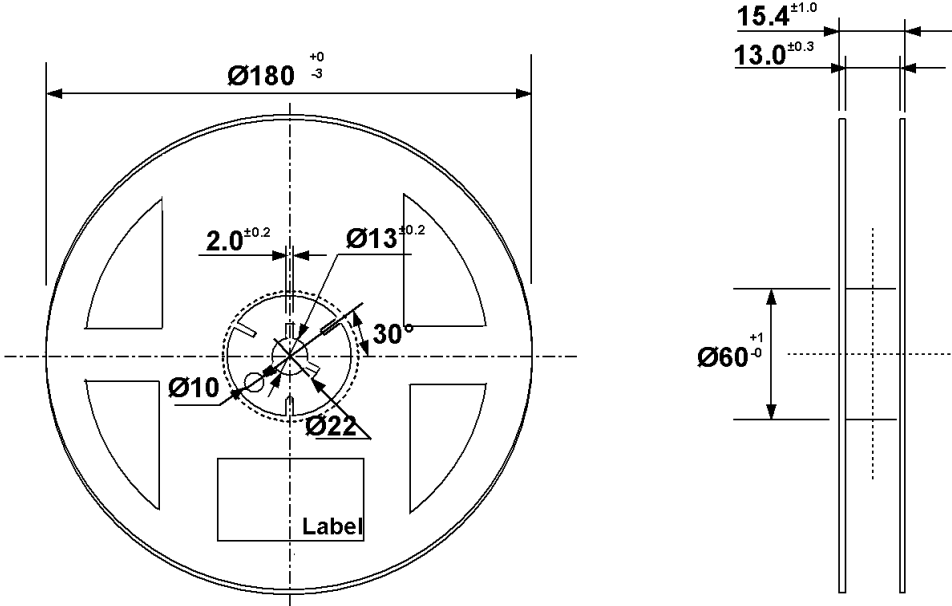
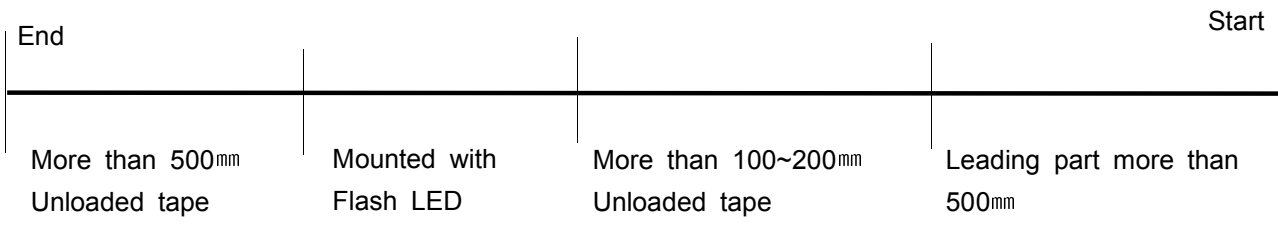
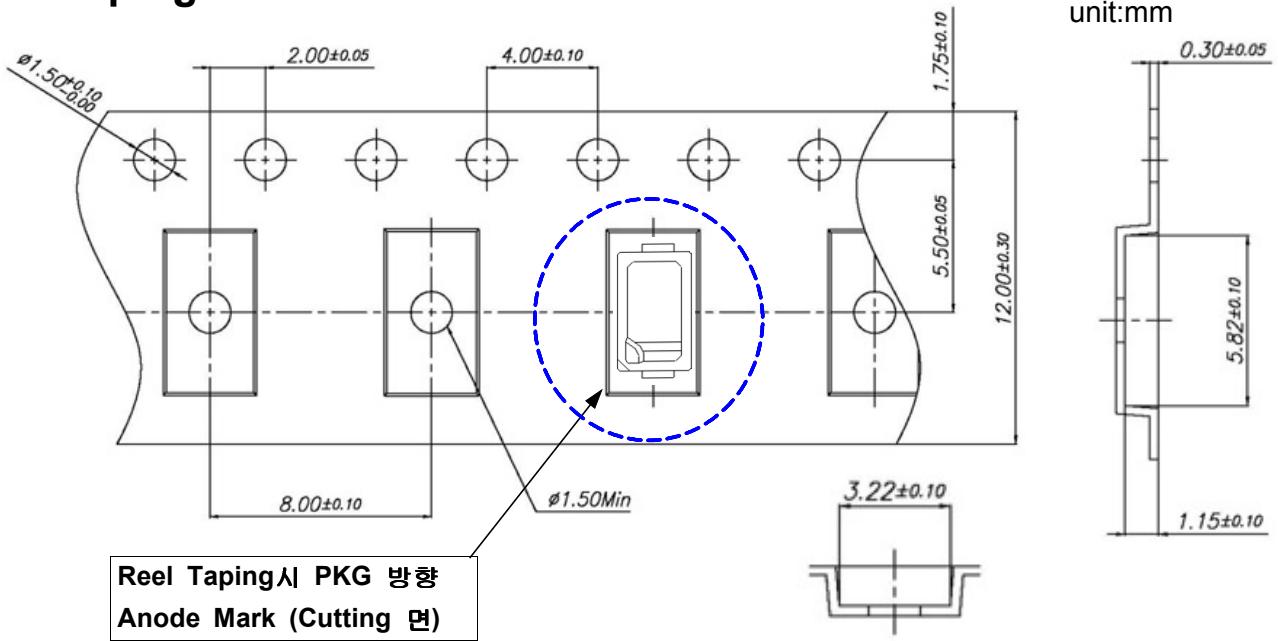

Tolerance ± 0.2 , Unit:mm

- (1) Quantity : The quantity/Reel to be Max. 1,000 pcs, .
- (2) Cumulative Tolerance : Cumulative tolerance/10 pitches to be ± 0.2 mm
- (3) Adhesion Strength of Cover Tape : Adhesion strength to be 0.1-0.7N when the cover tape is turned off from the carrier tape at 10°C angle to be the carrier tape.
- (4) Packaging : P/N, Manufacturing data code no. and quantity to be indicated on a damp proof Package.

10. Label Structure

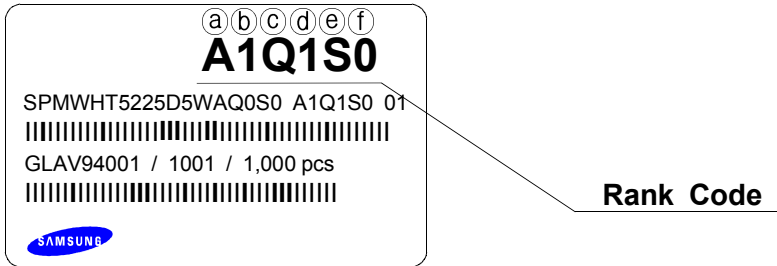

N.B) Denoted rank is the only example.

Rank Code

- ⒶⒷ : Forward Voltage(V_F) Rank (refer to page. 3)
- ⒸⒹ : Chromaticity Coordinate Rank (refer to page. 4)
- ⒺⒻ : Luminous Intensity(cd) Rank (refer to page. 3)

11. Lot Number

The Lot number is composed of the following characters

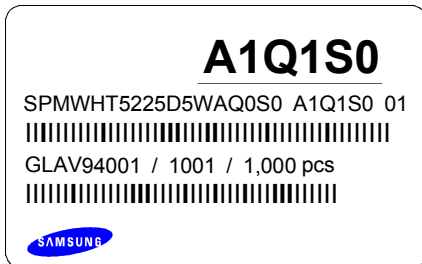

①②③④⑤⑥⑦⑧⑨ / 1ⒶⒷⒸ / 1,000 PCS

- ① : Production Site (S:SAMSUNG LED, G:GOSIN CHINA)
- ② : L (LED)
- ③ : Product State (A:Normality, B:Bulk, C:First Production, R:Reproduction, S:Sample)
- ④ : Year (V:2011, W:2012, X:2013...)
- ⑤ : Month (1 ~ 9, A, B)
- ⑥ : Day (1 ~ 9, A, B ~ V)
- ⑦⑧⑨ : SAMSUNG LED Product number (1 ~ 999)
- ⒶⒷⒸ : Reel Number (1 ~ 999)

12. Reel Packing Structure

Reel

A1Q1S0
 SPMWHT5225D5WAQ0S0 A1Q1S0 01
 GLAV94001 / 1001 / 1,000 pcs

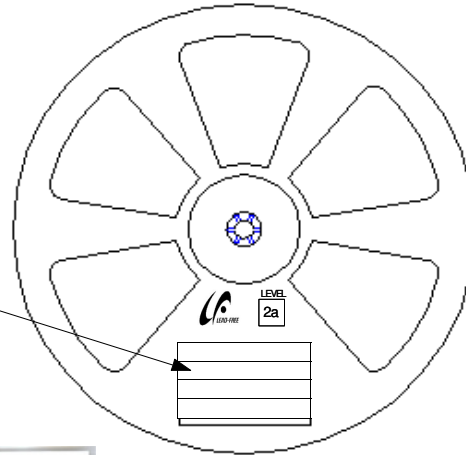
Aluminum Vinyl Bag

A1Q1S0
 SPMWHT5225D5WAQ0S0 A1Q1S0 01
 GLAV94001 / 1001 / 1,000 pcs



CAUTION LEVEL 2a
 MOISTURE SENSITIVE DEVICES

1. Do not touch the bag. It contains an e-ESD and ESDS.
2. Before opening, please inspect the bag for damage.
3. After the bag is opened, devices that will be subjected to either static or other high temperature protection must be removed within 473 hours of factory conditions of equal or less than 20% RH, 25°C, and 100% humidity.
4. Devices require 48hrs before assembly.
5. Humidity must be 20% RH.
6. Humidity indicator starts to turn yellow when at 20% RH, or it is not used.
7. If the indicator turns yellow, please do not use the device for 12 hours at 20% RH.
8. If the indicator turns red, please do not use the device for 12 hours at 20% RH.

Note: If device moisture level is subjected to high temperature or other high temperature, please refer to the following table for the repair procedure.
 (If there is any damage, please refer to the following table.)
 Note: Label and body temperature by 20°C (68°F) ± 0.5°C (± 0.9°F)

중요 사항
 이 알루미늄 비닐 봉지는 정전기로부터 제품을 보호하기 위하여 제작되었습니다. 개봉 후에는 즉시 습기 저항을 및 기타 보호를 적용하십시오.
 습기 및 정전기가 제품을 보호하기 위해 개봉 후 사용에 필요한 시간은 습도에 따라 달라집니다. 습도에 따라 필요한 시간은 아래 표를 참조하십시오. 습도에 따라 필요한 시간은 아래 표를 참조하십시오. 습도에 따라 필요한 시간은 아래 표를 참조하십시오.

Important
 This Al Ripper bag is designed to protect the enclosed products from moisture and ESD. Once opened, the products should be subjected with the printed circuit board immediately. When not in use, please do not leave the products unprotected by the Al Ripper bag. To repair unused products, please ensure the zip-lock is completely sealed with the dry pack left inside.

Material : Paper(SW3B(B))

TYPE	SIZE(mm)		
	L	W	H
7inch	245	220	182

① SIDE

A1Q1S0
 SPMWHT5225D5WAQ0S0 A1Q1S0 01
 GLAV94001 / 1001 / 10,000 pcs



[Box Label]

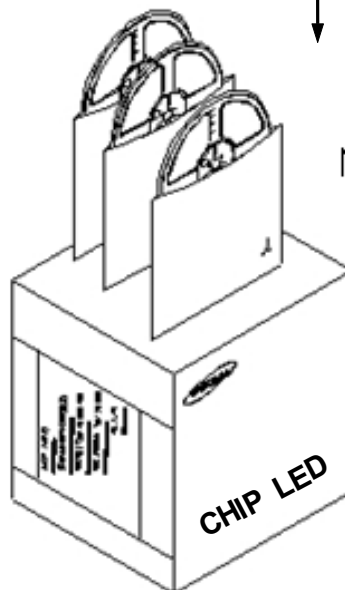

Max. 10,000 pcs

13. Aluminum Vinyl Bag



CAUTION

This bag contains
MOISTURE SENSITIVE DEVICES

LEVEL

2a

1. Shelf life in sealed bag: 12 months at 40°C and 90% relative humidity (RH)
2. Peak package body temperature: 240°C
3. After this bag is opened, devices that will be subjected to reflow solder or other high temperature processes must be:
 - a. Mounted within 672 hours at factory conditions of equal to or less than 30°C / 60% RH, or
 - b. Stored at 10% RH
4. Devices require bake, before mounting, if:
 - a. Humidity Indicator Card is > 65% when read at $23\pm 5^{\circ}\text{C}$, or
 - b. 2a is not met.
5. If baking is required, devices must be baked for 1 hours at $60\pm 5^{\circ}\text{C}$

Note: if device containers cannot be subjected to high temperature or shorter bake times are desired, reference IPC/JEDEC J-STD-033 for bake procedure,

Bag seal due date: _____
(if blank, see code label)

Note: Level and body temperature by IPC/JEDEC J-STD-020

A1Q1S0

SPMWHT5225D5WAQ0S0 A1Q1S0 01

GLAV94001 / 1001 / 1,000 pcs





주의 사항

이 알루미늄 지퍼 백은 습기 및 정전기로부터 제품을 보호하기 위하여 제작되었습니다. 개봉 후에는 즉시 솔더 작업을 실시하는 것을 권장합니다.

습기 및 정전기로부터 제품을 보호 하기 위해서 개봉 후 사용하지 않는 자재는 본 팩에 넣어 보관 하시기 바랍니다. 사용하지 않는 자재를 본 팩에 넣을 때는 반드시 동봉된 드라이 팩과 함께 넣고 지퍼부분을 완전하게 밀봉하여 주시기 바랍니다.

Important

This Al Zipper bag is designed to protect the enclosed products from moisture and ESD. Once opened, the products should be soldered onto the printed circuit board immediately. When not in use, please do not leave the products unprotected by the Al Zipper Bag. To repack unused products., please ensure the zip-lock is completely sealed with the dry pack left inside.

Silica gel & Humidity Indicator Card in Aluminum Vinyl Bag



14. Precaution for Use (취급상 주의사항)

- 1) For over-current-proof function, customers are recommended to apply resistors to prevent sudden change of the current caused by slight shift of the voltage.
과전류 방지를 위해 전압의 미세한 이동에 의해 야기되는 전류의 순간 변화를 방지하기 위해 저항 등의 설치를 권장함.
- 2) This device should not be used in any type of fluid such as water, oil, organic solvent, etc. When washing is required, IPA is recommended to use.
제품은 물, 오일, 유기물과 같은 액체 타입에서의 사용은 제한되며, 세정이 필요할 시에는 IPA 사용을 권장함.
- 3) When the LEDs illuminate, operating current should be decided after considering the ambient maximum temperature.
LED의 발광 시, 동작 전류는 주변 최고온도를 고려하여 결정되어야 함.
- 4) LEDs must be stored in a clean environment.
If the LEDs are to be stored for 3 months or more after being shipped from SLED, they should be packed by a sealed container with nitrogen gas injected.
(Shelf life of sealed bags: 12 months, temp. 0~40 °C, 20~70 %RH)
LED의 보관은 청정한 환경에서 보존되어야 하며, 만약 삼성LED로부터 공급받는 후 3개월 또는 그 이상 보관이 필요하다면 질소 가스를 동봉한 보존용기에 보관되어야 함.
(보존 bag의 수명 : 12 개월, 보존 온도 0~40 °C, 습도 20~70 %RH)
- 5) After storage bag is open, device subjected to soldering, solder reflow, or other high temperature processes must be:
보존 Bag이 개봉된 후에, 납땀이나 reflow 등의 높은 온도에 노출되는 제품은 다음의 사항에 부합되어야 함.
 - a. Mounted within 168 hours (7 days) at an assembly line with a condition of no more than 30 °C/60 %RH,
a. 제품은 30 °C/60 %RH보다 같거나 낮은 조립조건에서 168시간(7일)이내에 조립해야 함.
 - b. Stored at <10 %RH.
b. 10 % 이하의 상대습도에서 보관되어야 함.
- 6) Repack unused Products with anti-moisture packing, fold to close any opening and then store in a dry place.
사용하지 않은 제품은 방습팩에 넣어 개봉 부위를 닫아서 다시 포장한 후, 건조한 장소에서 보관할 것을 권장함.

7) Devices require baking before mounting, if humidity card reading is $>60\%$ at $23\pm 5\text{ }^{\circ}\text{C}$.

만약 습도표시카드의 수치가 $23\pm 5\text{ }^{\circ}\text{C}$ 에서 60% 이상이라면, 제품 실장 전에 baking하여야 함.

8) Devices must be baked for 24 hours at $65\pm 5\text{ }^{\circ}\text{C}$, if baking is required.

만약 baking이 필요하다면, 제품은 $65\pm 5\text{ }^{\circ}\text{C}$ 에서 24시간 정도 baking 되어야 함.

9) The LEDs are sensitive to the static electricity and surge. It is recommended to use a wrist band or anti-electrostatic glove when handling the LEDs.

LED는 정전기 및 서지에 민감한 제품이므로, LED 제품을 다룰 시에는 정전기 방지장갑이나 손목밴드를 사용하기를 권장함.

If voltage exceeding the absolute maximum rating is applied to LEDs, it may cause damage or even destruction to LED devices.

만약 절대 허용치를 초과하는 전압이 LED에 가해지면, LED 소자는 파괴되거나 손상될 수 있음.

Damaged LEDs may show some unusual characteristics such as increase in leak current, lowered turn-on voltage, or abnormal lighting of LEDs at low current.

손상된 제품은 누설전류의 증가, Turn on 전압의 저하, 저 전류에서의 점등불량 등의 이상 거동을 보일 수 있음.

15. Hazard Substance Analysis - SGS



Test Report No. F690501/LF-CTSAYAA11-16102

Issued Date: 2011. 05. 24 Page 1 of 7

To: **SAMSUNG LED**
 #314, Maetan-Dong
 Youngtong-Gu
 Suwon-si
 Gyeonggi-do
 Korea

The following merchandise was submitted and identified by the client as :

SGS File No. : AYAA11-16102
 Product Name : 5830
 Item No./Part No. : N/A
 Received Date : 2011. 05. 17
 Test Period : 2011. 05. 18 to 2011. 05. 24
 Test Results : For further details, please refer to following page(s)
 Test Performed : SGS Korea tested the sample(s) selected by applicant with following results.

Timothy Jeon
 Jinhee Kim
 Cindy Park
 Jerry Jung/ Testing Person

SGS Korea Co. Ltd.

Jeff Jang / Chemical Lab Mgr

This document is issued by the Company subject to its General Conditions of Service printed hereon, available on request or accessible at www.sgslab.com/eng/condition and, for electronic format documents, subject to Terms and Conditions for Electronic Documents at www.sgslab.com/eng/condition. Reference is made to the limitation of liability, indemnification and jurisdiction issues defined therein. Any holder of this document is advised that information contained herein reflects the Company's findings at the time of its issuance only and under the terms of Client's instructions, if any. The Company's sole responsibility is to its Client and this document does not constitute advice to a transaction from exercising all their rights and obligations under the transaction documents. This document cannot be reproduced except in full, without prior written approval of the Company. Any unauthorized alteration, forgery or falsification of the content or appearance of this document is unlawful and offenders may be prosecuted to the fullest extent of the law. Unless otherwise stated the results shown in this test report refer only to the sample(s) tested and each sample(s) are retained for 180 days only.



Test Report No. F690501/LF-CTSAYAA11-16102

Issued Date: 2011. 05. 24 Page 2 of 7

Sample No. : AYAA11-16102.001
 Sample Description : 5830
 Item No./Part No. : N/A

Heavy Metals

Test Items	Unit	Test Method	MDL	Results
Cadmium (Cd)	mg/kg	With reference to IEC 62321:2008, ICP	0.5	N.D.
Lead (Pb)	mg/kg	With reference to IEC 62321:2008, ICP	5	N.D.
Mercury (Hg)	mg/kg	With reference to IEC 62321:2008, ICP	2	N.D.
Hexavalent Chromium (Cr VI)	mg/kg	With reference to IEC 62321:2008, UV-VIS	1	N.D.
Arsenic (As)	mg/kg	With reference to EPA 3052(1996), US EPA 6010B(1996), ICP	10	N.D.
Sb (Sb2O3)	mg/kg	With reference to EPA 3052(1996), US EPA 6010B(1996), ICP	10	N.D.
Beryllium (Be)	mg/kg	With reference to EPA 3050B(1996), US EPA 6010B(1996), ICP	0.5	N.D.

Flame Retardants-PBBs/PBDEs

Test Items	Unit	Test Method	MDL	Results
Monobromobiphenyl	mg/kg	With reference to IEC 62321:2008, GC-MS	5	N.D.
Dibromobiphenyl	mg/kg	With reference to IEC 62321:2008, GC-MS	5	N.D.
Tribromobiphenyl	mg/kg	With reference to IEC 62321:2008, GC-MS	5	N.D.
Tetrabromobiphenyl	mg/kg	With reference to IEC 62321:2008, GC-MS	5	N.D.
Pentabromobiphenyl	mg/kg	With reference to IEC 62321:2008, GC-MS	5	N.D.
Hexabromobiphenyl	mg/kg	With reference to IEC 62321:2008, GC-MS	5	N.D.
Heptabromobiphenyl	mg/kg	With reference to IEC 62321:2008, GC-MS	5	N.D.
Octabromobiphenyl	mg/kg	With reference to IEC 62321:2008, GC-MS	5	N.D.
Nonabromobiphenyl	mg/kg	With reference to IEC 62321:2008, GC-MS	5	N.D.
Decabromobiphenyl	mg/kg	With reference to IEC 62321:2008, GC-MS	5	N.D.
Monobromodiphenyl ether	mg/kg	With reference to IEC 62321:2008, GC-MS	5	N.D.
Dibromodiphenyl ether	mg/kg	With reference to IEC 62321:2008, GC-MS	5	N.D.
Tribromodiphenyl ether	mg/kg	With reference to IEC 62321:2008, GC-MS	5	N.D.
Tetrabromodiphenyl ether	mg/kg	With reference to IEC 62321:2008, GC-MS	5	N.D.
Pentabromodiphenyl ether	mg/kg	With reference to IEC 62321:2008, GC-MS	5	N.D.

NOTE: (1) N.D. = Not detected.(<MDL)
 (2) mg/kg = ppm
 (3) MDL = Method Detection Limit
 (4) - = No regulation
 (5) ** = Qualitative analysis (No Unit)
 (6) * = Boiling-water-extraction:
 Negative = Absence of CrVI coating
 Positive = Presence of CrVI coating; the detected concentration in boiling-water-extraction solution is equal or greater than 0.02 mg/kg with 50 cm2 sample surface area.

This document is issued by the Company subject to its General Conditions of Service printed on each contract, available on request at www.sgs.com and its electronic format documents, subject to Terms and Conditions for Electronic Documents at www.sgs.com. Please be aware of the limitation of liability, indemnification and arbitration clauses defined therein. Any holder of this document is invited to verify the information contained therein through the Company's website at the time of its utilization only and within the area of Client's jurisdiction. It is the Client's sole responsibility to be in touch with the document data and maintain copies to a transaction from exercising all their rights and obligations under the transaction documents. This document cannot be reproduced except in full, without prior written approval of the Company. Only authorized electronic, highly an individual of the content or appearance of this document is considered authentic only for procedures in the future event of a law. Unless otherwise stated the results shown in this report refer only to the samples tested and such samples are retained for 180 days only.

F052 Version4

SGS Korea Co.,Ltd.

322, The O valley, 556-9, Hogeje-dong, Dongan-gu, Anyang-si, Gyeonggi-do, Korea 431-000
 t +82 (0)31 4506 000 f +82 (0)31 4506 050 <http://www.sgsled.co.kr> www.ky.sgs.com/sgsled

Member of the SGS Group (Société Générale de Surveillance)



Test Report No. F690501/LF-CTSAYAA11-16102

Issued Date: 2011. 05. 24 Page 3 of 7

Sample No. : AYAA11-16102.001
 Sample Description : 5830
 Item No./Part No. : N/A

Flame Retardants-PBBs/PBDEs

Test Items	Unit	Test Method	MDL	Results
Hexabromodiphenyl ether	mg/kg	With reference to IEC 62321:2008, GC-MS	5	N.D.
Heptabromodiphenyl ether	mg/kg	With reference to IEC 62321:2008, GC-MS	5	N.D.
Octabromodiphenyl ether	mg/kg	With reference to IEC 62321:2008, GC-MS	5	N.D.
Nonabromodiphenyl ether	mg/kg	With reference to IEC 62321:2008, GC-MS	5	N.D.
Decabromodiphenyl ether	mg/kg	With reference to IEC 62321:2008, GC-MS	5	N.D.

Phthalates

Test Items	Unit	Test Method	MDL	Results
Di-isodecyl phthalate (DIDP)	mg/kg	US EPA 8061A, GC/MS	50	N.D.
Di-isononyl phthalate (DINP)	mg/kg	US EPA 8061A, GC/MS	50	N.D.
Di-n-octyl phthalate (DNOP)	mg/kg	US EPA 8061A, GC/MS	50	N.D.
Di-ethyl phthalate(DEP)	mg/kg	US EPA 8061A, GC/MS	50	N.D.
Di-methyl phthalate (DMP)	mg/kg	US EPA 8061A, GC/MS	50	N.D.

Halogen Contents

Test Items	Unit	Test Method	MDL	Results
Bromine(Br)	mg/kg	BS EN 14582:2007, IC	30	N.D.
Chlorine(Cl)	mg/kg	BS EN 14582:2007, IC	30	N.D.
Fluorine(F)	mg/kg	BS EN 14582:2007, IC	30	191
Iodine(I)	mg/kg	BS EN 14582:2007, IC	50	N.D.

Organotin Compounds

Test Items	Unit	Test Method	MDL	Results
Tributyltin (TBT)	mg/kg	DIN 38407-13, GC/MS	0.1	N.D.

NOTE: (1) N.D. = Not detected.(<MDL)
 (2) mg/kg = ppm
 (3) MDL = Method Detection Limit
 (4) - = No regulation
 (5) ** = Qualitative analysis (No Unit)
 (6) * = Boiling-water-extraction:
 Negative = Absence of CrVI coating
 Positive = Presence of CrVI coating; the detected concentration in boiling-water-extraction solution is equal or greater than 0.02 mg/kg with 50 cm² sample surface area.

This document is issued by the Company subject to its General Conditions of Service printed on each contract, available on request on www.sgs.com and, for electronic format documents, subject to Terms and Conditions for Electronic Documents at www.sgs.com. Please be aware in the location of liability, indemnification and jurisdiction issues defined therein. Any holder of this document is invited to contact the appropriate contact person within the Company's branch at the time of its preparation only and within the area of Client's responsibility. The Company's sole responsibility is to its Client and this document does not constitute part of a transaction from marketing of test rights and obligations under the transaction concerned. This document cannot be reproduced except in full, without prior written approval of the Company. Only authorized electronic, highly confidential information of the Company or appearance of this document in electronic databases may be produced by the Client upon its consent. Unless otherwise stated the results shown in this report refer only to the sample(s) tested and such sample(s) are retained for 90 days only.



Test Report No. F690501/LF-CTSAYAA11-16102

Issued Date: 2011. 05. 24 Page 4 of 7

Sample No. : AYAA11-16102.001
 Sample Description : 5830
 Item No./Part No. : N/A

Organotin Compounds

Test Items	Unit	Test Method	MDL	Results
Triphenyltin (TPhT)	mg/kg	DIN 38407-13 , GC/MS	0.1	N.D.
Dibutyltin (DBT)	mg/kg	DIN 38407-13 , GC/MS	0.1	N.D.
Dioctyltin(DOT)	mg/kg	DIN 38407-13 , GC/MS	0.1	N.D.
Monobutyltin (MBT)	mg/kg	DIN 38407-13 , GC/MS	0.1	N.D.
Bis (tributyltin)oxide (TBTO)	mg/kg	DIN 38407-13 , GC/MS	0.1	N.D.

Other(s)

Test Items	Unit	Test Method	MDL	Results
PFOS(Perfluorooctane Sulfonates-Acid/Metal Salt/Amide)	mg/kg	US EPA 3540C/3550C, LC/MS	1	N.D.

- NOTE:
- (1) N.D. = Not detected.(<MDL)
 - (2) mg/kg = ppm
 - (3) MDL = Method Detection Limit
 - (4) - = No regulation
 - (5) ** = Qualitative analysis (No Unit)
 - (6) * = Boiling-water-extraction:
 Negative = Absence of CrVI coating
 Positive = Presence of CrVI coating; the detected concentration in boiling-water-extraction solution is equal or greater than 0.02 mg/kg with 50 cm2 sample surface area.

This document is issued by the Company subject to its General Conditions of Service printed on each report or available at www.sgs.com and its electronic format documents, subject to Terms and Conditions for Electronic Documents at www.sgs.com. Reference is made to the location of sales, subsidiaries and branches listed herein. Any holder of this document is invited to inform the nearest branch within the Company's facility at the time of its submission only and within the area of Client's jurisdiction, if any. The Company's sole responsibility is to its Client and this document does not constitute part of a transaction from which any rights and obligations under the transaction document. This document cannot be reproduced except in full without prior written approval of the Company. Copy controlled electronic, highly or modification of the content or appearance of this document is prohibited and references only for production to the latest extent of the law. Unless otherwise stated the results shown in this report apply only to the sample(s) tested and such sample(s) are retained for 180 days only.

F052 Version4

SGS Korea Co., Ltd.

322, The O valley, 556-9, Hoge-dong, Dongan-gu, Anyang-si, Gyeonggi-do, Korea 431-000
 t +82 (0)31 4506 000 f +82 (0)31 4506 050 <http://korea.sgs.com> www.ky.sgs.com/greentab

Member of the SGS Group (Société Générale de Surveillance)



Test Report No. F690501/LF-CTSAYAA11-16102

Issued Date: 2011. 05. 24 Page 5 of 7

Picture of Sample as Received:



NOTE:

- (1) N.D. = Not detected.(<MDL)
- (2) mg/kg = ppm
- (3) MDL = Method Detection Limit
- (4) - = No regulation
- (5) ** = Qualitative analysis (No Unit)
- (6) * = Boiling-water-extraction:
 Negative = Absence of CrVI coating
 Positive = Presence of CrVI coating; the detected concentration in boiling-water-extraction solution is equal or greater than 0.02 mg/kg with 50 cm2 sample surface area.

This document is issued by the Company subject to its General Conditions of Service printed on request or available at www.sgs.com and, for electronic format documents, subject to Terms and Conditions for Electronic Documents at www.sgs.com. Attention is drawn to the limitation of liability, indemnification and jurisdiction issues defined therein. Any holder of this document is invited to contact the information contained herein within the Company's facilities at the time of its intervention only and under the authority of Client's instructions. The Company's sole responsibility is to its Client and this document does not constitute proof of a transaction from avoidance of their rights and obligations under the transaction documents. This document cannot be reproduced except in full, without prior written approval of the Company. Any unauthorized alteration, forgery or falsification of the content or appearance of this document is unlawful and constitutes a criminal offence in the jurisdiction of the law. Unless otherwise stated the results shown in this report refer only to the sample(s) tested and such results are valid for 180 days only.

F052 Version4

SGS Korea Co., Ltd.

322, The O'valley, 556-9, Hoge-dong, Dongan-gu, Anyang-si, Gyeonggi-do, Korea 431-030
 t +82 (0)31 4608 000 f +82 (0)31 4608 059 <http://www.sgslab.co.kr> www.kr.sgs.com kr@sgslab.com

Member of the SGS Group (Société Générale de Surveillance)



Test Report No. F690501/LF-CTSAYAA11-16102

Issued Date: 2011. 05. 24 Page 6 of 7

Flow Chart for RoHS: Cd/Pb/Hg/Cr⁶⁺/PBBs&PBDEs Testing

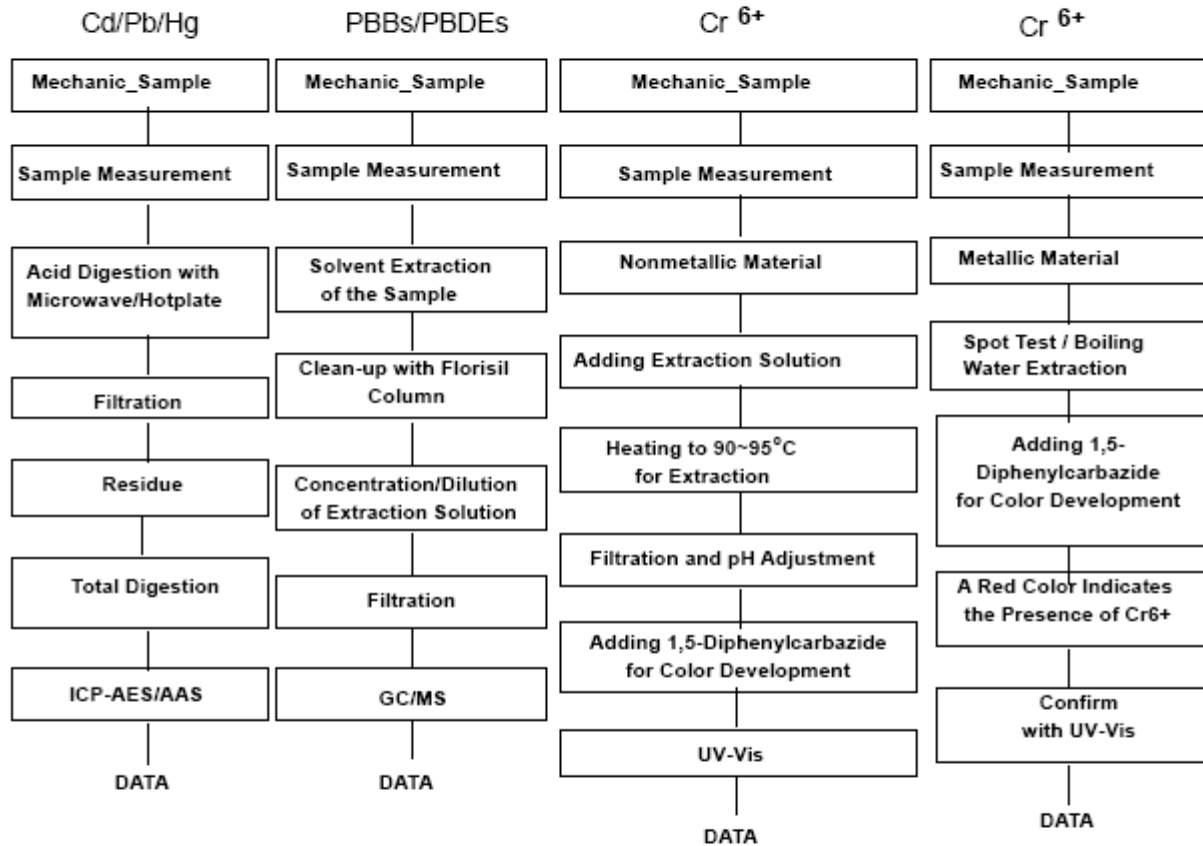

The samples were dissolved totally by pre-conditioning method according to above flow chart for Cd,Pb,Hg.

Section Chief : Gilsae Yi

NOTE:

- (1) N.D. = Not detected.(<MDL)
- (2) mg/kg = ppm
- (3) MDL = Method Detection Limit
- (4) - = No regulation
- (5) ** = Qualitative analysis (No Unit)
- (6) * = Boiling-water-extraction:
 Negative = Absence of CrVI coating
 Positive = Presence of CrVI coating; the detected concentration in boiling-water-extraction solution is equal or greater than 0.02 mg/kg with 50 cm² sample surface area.

This document is issued by the Company subject to its General Conditions of Service printed on each report or available at www.sgs.com and, for electronic format documents, subject to Terms and Conditions for Electronic Documents at www.sgs.com. Reference is made to the location of testing, identification and production codes marked thereon. Any holder of this document is invited to contact the information concerned herein within the Company's facilities at the time of its preparation only and within the area of Company's jurisdiction. The Company's sole responsibility is to its Client and this document does not constitute a contract. The document cannot be reproduced except in full, without prior written approval of the Company. Any unauthorised alteration, forgery or falsification of the content or appearance of this document is unlawful and constitutes a criminal offence in the jurisdiction of the issuer.

F052 Version4

SGS Korea Co., Ltd.

322, The O valley, 556-9, Hoge-dong, Dongan-gu, Anyang-si, Gyeonggi-do, Korea 431-000
 t +82 (0)31 4506 000 f +82 (0)31 4506 050 <http://www.spslab.co.kr> www.ky.sgs.com www.kr.sgs.com

Member of the SGS Group (Société Générale de Surveillance)



Test Report No. F690501/LF-CTSAYAA11-16102

Issued Date: 2011. 05. 24 Page 7 of 7

Flow Chart for Halogen Test

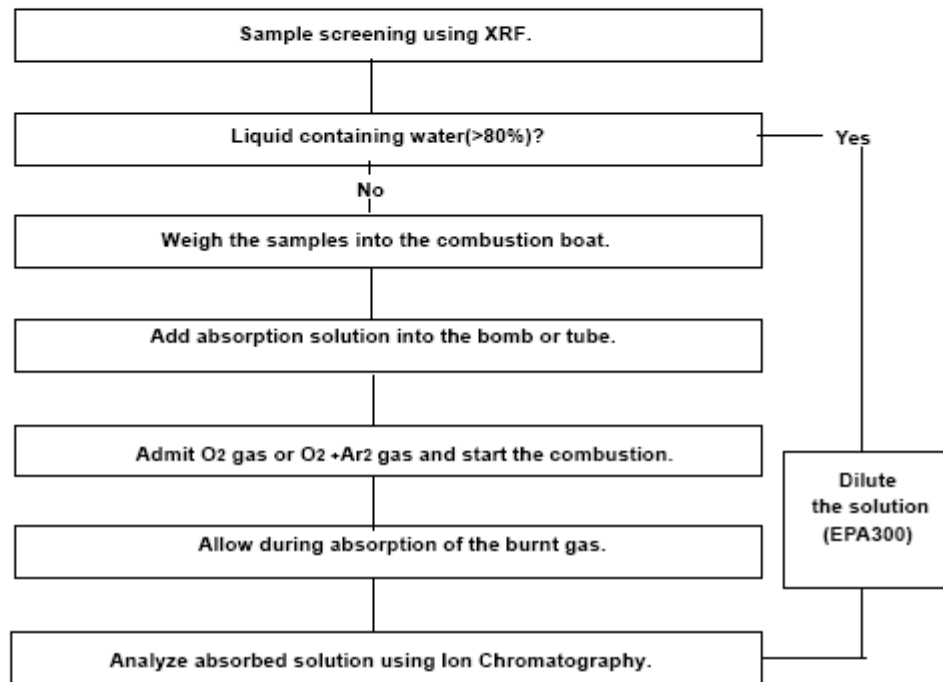

*** End ***

NOTE:

- (1) N.D. = Not detected.(<MDL)
- (2) mg/kg = ppm
- (3) MDL = Method Detection Limit
- (4) - = No regulation
- (5) ** = Qualitative analysis (No Unit)
- (6) * = Boiling-water-extraction:
 Negative = Absence of CrVI coating
 Positive = Presence of CrVI coating; the detected concentration in boiling-water-extraction solution is equal or greater than 0.02 mg/kg with 50 cm2 sample surface area.

This document is issued by the Company subject to its General Conditions of Service printed on each report or available at www.sgs.com and, for electronic format documents, subject to Terms and Conditions for Electronic Documents at www.sgs.com. Reference is made to the location of safety, identification and protection marks marked thereon. Any holder of this document is invited to contact the information contained therein within the Company's facilities at the time of its preparation only and under the strict confidentiality of the Company's information. The Company's sole responsibility is to its Client and this document does not constitute a contract. The document cannot be reproduced except in full, without prior written approval of the Company. Any unauthorised alteration, forgery or falsification of the content or appearance of this document is unlawful and constitutes a criminal offence in the United Kingdom of Great Britain and Northern Ireland.

F052 Version4

SGS Korea Co.,Ltd.

322, The O valley, 556-9, Hoge-dong, Dongan-gu, Anyang-si, Gyeonggi-do, Korea 431-000
 t +82 (0)31 4506 000 f +82 (0)31 4506 050 <http://korea.sgs.com> www.ky.sgs.com/greenlab

Member of the SGS Group (Société Générale de Surveillance)

16. Hazard Substance Analysis - SVHC(REACH)



Test Report No. F690501/LF-CTSAYAA11-16099 **Issued Date:** May 24, 2011 **Page 1 of 8**

To: **SAMSUNG LED**
 #314, Maetan3-Dong
 Yeongtong-gu
 Suwon-city
 Gyeonggi-do
 Korea

The following sample(s) was/were submitted and identified by/on behalf of the client as:-

Product Name : 5630 White
Item/Part Name : N/A
SGS File No. : AYAA11-16099
Received Date : May 17, 2011
Test Period : May 18, 2011 ~ May 24, 2011
Test Performed : SGS Korea tested the sample(s) selected by applicant with following results
Test Requested : Forty-six (46) substances in the Candidate List of Substances of Very High Concern (SVHC) for authorization published by European Chemicals Agency (ECHA) on and before December 15, 2010 regarding Regulation (EC) No 1907/2006 concerning the REACH.
Test Method : Please refer to next page(s).
Test Result(s) : Please refer to next page(s).
Summary : According to the specified scope and analytical technique, concentrations of all SVHC are <0.1% in the submitted sample(s).

Timothy Jeon
 Cindy park
 Jinhee Kim
 Sophia Kim
 /Testing Person

SGS Korea Co., Ltd

Jeff Jang / Technical Mgr

This document is issued by the Company, subject to its General Conditions of Service printed overleaf, and also in respect of applicable regulations and specifications, and, for electronic format documents, subject to Terms and Conditions for Electronic Documents as well as conditions of discharge. Analysis is drawn to the attention of testing, identification and jurisdiction issued defined therein. Any holder of this document is hereby notified that the information contained herein reflects the Company's findings at the time of its issuance only and within the limit of client's instructions, if any. The Company's sole responsibility is to its Client and the document does not constitute parties to a transaction from assuming all their rights and obligations under the transaction documents. This document cannot be reproduced in any form without prior written approval of the Company. Any unauthorized alteration, forgery or falsification of the content or appearance of this document is unlawful and offenders may be prosecuted to the fullest extent of the law. Unless otherwise stated the results shown in this report refer only to the samples tested and such samples are retained for 90 days only.

F052 Version4

SGS Korea Co., Ltd.

322, The O valley, 555-9, Hoge-dong, Dongan-gu, Anyang-si, Gyeonggi-do, Korea 431-080
 1+82 (0)31 4608 000 1+82 (0)31 4608 050 <http://www.sgslab.co.kr> www.kr.sgs.com/crenlab

Member of the SGS Group (Société Générale de Surveillance)



Test Report No. F690501/LF-CTSAYAA11-16099 Issued Date: May 24, 2011 Page 2 of 8

Test Method:

SGS In-House method-RSTS-SVHC-102-2, 3 and ZLS standard ZEK 01.2-08. Analyzed by ICP-OES, PLM, UV/VIS, LC/MS and GC/MS.

Remarks:

1. The chemical analysis of specified SVHC is performed by means of currently available analytical techniques against the following SVHC related documents published by ECHA: These lists are under evaluation by ECHA and may subject to change in the future.
Refer to: http://echa.europa.eu/chem_data/authorisation_process/candidate_list_table_en.asp
Refer to: http://echa.europa.eu/news/pr/201012/pr_10_26_svhc_candidate_list_20101215_en.asp
2. In accordance with Regulation (EC) No 1907/2006, any producer or importer of articles shall notify ECHA, in accordance with paragraph 2 of Article 7, if a substance meets the criteria in Article 57 and is identified in accordance with Article 59(1) of the Regulation, if (a) the substance is present in those articles in quantities totaling over one tonne per producer or importer per year; and (b) the substance is present in those articles above a concentration of 0.1% weight by weight (w/w).
3. Article 33 of Regulation (EC) No 1907/2006 requires supplier of an article containing a substance meeting the criteria in Article 57 and identified in accordance with Article 59(1) in a concentration above 0.1% weight by weight (w/w) shall provide the recipient of the article with sufficient information, available to the supplier, to allow safe use of the article including, as a minimum, the name of that substance in the Candidate List.
4. If a SVHC is found over the reporting limit, client is suggested to identify the component which contains the SVHC and the exact concentration of the SVHC by requesting further quantitative analysis from the laboratory.

This document is issued by the Company, subject to its General Conditions of Service printed hereon, available on request or accessible at www.sgs.com, and, for electronic format documents, subject to Terms and Conditions for Electronic Documents at www.sgs.com/led. Analysis is drawn to the attention of liability, identification and jurisdiction issued defined therein. Any holder of this document is notified that the holder concerned, however, cannot release the Company's findings in the form of its transmission copy and within the limit of client's transactions, if any. The Company's sole responsibility is to its Client and the document does not constitute parties to a transaction from availing all their rights and obligations under the transaction documents. This document cannot be reproduced in any form without prior written approval of the Company. Any unauthorized alteration, forgery or falsification of the content or appearance of this document is unlawful and offenders may be prosecuted to the fullest extent of the law. Unless otherwise stated the results shown in this test report are only in the sample tested and such samples are retained for 90 days only.

F052 Version4

SGS Korea Co., Ltd.

322, The O valley, 555-9, Hoge-dong, Dongan-gu, Anyang-si, Gyeonggi-do, Korea 431-080
T+82 (0)31 4608 000 F+82 (0)31 4608 050 <http://www.sgslab.co.kr> www.kr.sgs.com/cn/en/lab

Member of the SGS Group (Société Générale de Surveillance)



Test Report No. F690501/LF-CTSAYAA11-16099 Issued Date: May 24, 2011 Page 3 of 8

Test Result(s)

Substance Name	CAS number	EC number	Concentration (%)	Reporting Limit (%)	Classification
Alkanes, C10-13, chloro (Short Chain Chlorinated Paraffins)	85535-84-8	287-476-5	N.D.	0.05	PBT
Anthracene	120-12-7	204-371-1	N.D.	0.05	PBT
Benzyl butyl phthalate (BBP)	85-68-7	201-622-7	N.D.	0.05	Toxic to Reproduction Category 2
Bis (2-ethylhexylphthalate) (DEHP)	117-81-7	204-211-0	N.D.	0.05	Toxic to Reproduction Category 2
Bis(tributyltin)oxide*	56-35-9	200-268-0	N.D.	0.05	PBT
Cobalt dichloride*	7646-79-9	231-589-4	N.D.	0.005	Carcinogen Category 2
4,4Diaminodiphenylmethane	101-77-9	202-974-4	N.D.	0.05	Carcinogen Category 2
Diarsenic pentaoxide*	1303-28-2	215-116-9	N.D.	0.005	Carcinogen Category 1
Diarsenic trioxide*	1327-53-3	215-481-4	N.D.	0.005	Carcinogen Category 1
Dibutyl phthalate (DBP)	84-74-2	201-557-4	N.D.	0.05	Toxic to Reproduction Category 2
Hexabromocyclododecane (HBCDD) and all major diastereoisomers identified (α-HBCDD, β-HBCDD, γ-HBCDD)	25637-99-4 and 3194-55-6 (134237-51-7, 134237-50-6, 134237-52-8)	247-148-4 and 221-695-9	N.D.	0.05	PBT
Lead hydrogen arsenate*	7784-40-9	232-064-2	N.D.	0.005	Carcinogen Category 1; Toxic to Reproduction Category 1
Sodium dichromate (Sodium dichromate, dehydrate)	10588-01-9 (7789-12-0)	234-190-3	N.D.	0.005	Carcinogen Category 2; Mutagen Category 2; Toxic to Reproduction Category 2
5-tert-butyl-2,4,6-trinitro-m-xylene (musk xylene)	81-15-2	201-329-4	N.D.	0.05	vPvB
Triethyl arsenate*	15606-95-8	427-700-2	N.D.	0.005	Carcinogen Category 1

This document is issued by the Company, subject to its General Conditions of Service printed overleaf, available on request or accessible at www.sgs.com, and, for electronic format documents, subject to Terms and Conditions for Electronic Documents at www.sgs.com/led. Access to it is granted to the Client and the document does not constitute a contract. Any holder of this document or holder of this information shall be deemed to have accepted the Company's findings at the time of its issuance and within the limit of Client's instructions, if any. The Company's sole responsibility is to its Client and the document does not constitute a contract. Any holder of this document or holder of this information shall be deemed to have accepted the Company's findings at the time of its issuance and within the limit of Client's instructions, if any. The Company's sole responsibility is to its Client and the document does not constitute a contract. Any holder of this document or holder of this information shall be deemed to have accepted the Company's findings at the time of its issuance and within the limit of Client's instructions, if any. Unless otherwise stated the results shown in this report refer only to the samples tested and such samples are retained for 90 days only.

F052 Version4

SGS Korea Co., Ltd.

322, The O valley, 555-9, Hoggae-dong, Dongan-gu, Anyang-si, Gyeonggi-do, Korea 431-060
 t+82 (0)31 4608 000 f+82 (0)31 4608 050 <http://www.sgsled.co.kr> www.kr.sgs.com/krenglish

Member of the SGS Group (Société Générale de Surveillance)

SGS
Test Report No. F690501/LF-CTSAYAA11-16099

Issued Date: May 24, 2011 Page 4 of 8

Substance Name	CAS number	EC number	Concentration (%)	Reporting Limit (%)	Classification
Di-isobutyl phthalate(DIBP)	84-69-5	201-553-2	N.D.	0.05	Toxic to Reproduction Category 2
2,4-Dinitrotoluene	121-14-2	204-450-0	N.D.	0.05	Carcinogen Category 2
Tris(2-chloroethyl) phosphate	115-96-8	204-118-5	N.D.	0.05	Toxic to Reproduction Category 2
Anthracene oil	90640-80-5	292-602-7	N.D.	0.05	PBT; vPvB Carcinogen Category 2
Anthracene oil, anthracene paste; distn. Lights	91995-17-4	295-278-5	N.D.	0.05	PBT; vPvB; Carcinogen Category 2; Mutagen Category 2
Anthracene oil, anthracene paste, anthracene fraction	91995-15-2	295-275-9	N.D.	0.05	PBT; vPvB; Carcinogen Category 2; Mutagen Category 2
Anthracene oil, anthracene-low	90640-82-7	292-604-8	N.D.	0.05	PBT; vPvB; Carcinogen Category 2; Mutagen Category 2
Anthracene oil, anthracene paste	90640-81-6	292-603-2	N.D.	0.05	PBT; vPvB; Carcinogen Category 2; Mutagen Category 2
Coal tar pitch, high temperature	65996-93-2	266-028-2	N.D.	0.05	PBT; vPvB; Carcinogen Category 2
Aluminosilicate, Refractory Ceramic Fibres*	-	650-017-00-8 (Index no.)	N.D.	0.005	Carcinogen Category 2
Zirconia Aluminosilicate, Refractory Ceramic Fibres*	-	650-017-00-8 (Index no.)	N.D.	0.005	Carcinogen Category 2
Lead sulfochromate yellow (C.I. Pigment Yellow 34)*	1344-37-2	215-693-7	N.D.	0.005	Carcinogen Category 2; Toxic to Reproduction Category 1
Lead chromate molybdate sulfate red (C.I. Pigment Red 104)*	12656-85-8	235-759-9	N.D.	0.005	Carcinogen Category 2; Toxic to Reproduction Category 1
Lead chromate*	7758-97-6	231-846-0	N.D.	0.005	Carcinogen Category 2; Toxic to Reproduction Category 1
Acrylamide	79-06-01	201-173-7	N.D.	0.05	Carcinogen Category 2; Mutagen Category 2

This document is issued by the Company, subject to its General Conditions of Service printed overleaf, available on request or accessible at www.sgs.com, and, for electronic format documents, subject to Terms and Conditions for Electronic Documents at www.sgs.com/led. Access to it is given to the Inquirer of Inquiry, Identification or Accreditation issued online therein. Any holder of the document or holder of the identification concerned herein releases the Company's liability in the event of its transmission only and within the limit of Client's instructions, if any. The Company's sole responsibility is to its Client and the document does not constitute advice or a transaction from involving all their rights and obligations under the transaction documents. This document cannot be reproduced or used in full without prior written approval of the Company. Any unauthorized alteration, copying or distribution of the content or appearance of this document is unlawful and offenders may be prosecuted to the fullest extent of the law. Unless otherwise stated the results shown in this test report refer only to the samples tested and such samples are retained for 90 days only.

F052 Version4

SGS Korea Co., Ltd.

322, The O valley, 555-9, Hoggae-dong, Dongan-gu, Anyang-si, Gyeonggi-do, Korea 431-060
 t+82 (0)31 4608 000 f+82 (0)31 4608 050 <http://www.sgslab.co.kr> www.kr.sgs.com/kr/en/lab

Member of the SGS Group (Société Générale de Surveillance)



Test Report No. F690501/LF-CTSAYAA11-16099 Issued Date: May 24, 2011 Page 5 of 8

Substance Name	CAS number	EC number	Concentration (%)	Reporting Limit (%)	Classification
Boric acid*	10043-35-3 11113-50-1	233-139-2 234-343-4	N.D.	0.005	Toxic to Reproduction Category 2
Disodium tetraborate, anhydrous*	1330-43-4 12179-04-3 1303-96-4	215-540-4	N.D.	0.005	Toxic to Reproduction Category 2
Tetraboron disodium heptaoxide, hydrate*	12267-73-1	235-541-3	N.D.	0.005	Toxic to Reproduction Category 2
Trichloroethylene	79-01-6	201-167-4	N.D.	0.05	Carcinogen Category 2
Sodium chromate *	7775-11-3	231-889-5	N.D.	0.005	Carcinogen Category 2; Mutagen Category 2; Toxic to Reproduction Category 2
Ammonium dichromate *	7789-09-5	232-143-1	N.D.	0.005	Carcinogen Category 2; Mutagen Category 2; Toxic to Reproduction Category 2
Potassium dichromate *	7778-50-9	231-906-6	N.D.	0.005	Carcinogen Category 2; Mutagen Category 2; Toxic to Reproduction Category 2
Potassium chromate *	7789-00-6	232-140-5	N.D.	0.005	Carcinogen Category 2; Mutagen Category 2

This document is issued by the Company, subject to its General Conditions of Service printed overleaf, available on request or accessible at www.sgs.com, and, for electronic format documents, subject to Terms and Conditions for Electronic Documents at www.sgs.com/led. Access to it is given to the Invoicing Client, or its subcontractors, for the purpose of invoicing, identification and/or production. Any holder of this document or holder of the information contained herein releases the Company's liability in the event of its dissemination and within the limit of Client's instructions, if any. The Company's sole responsibility is to its Client and the document does not constitute advice or a transaction from seeking all their rights and obligations under the Invoicing document. This document cannot be reproduced as such in full, without prior written approval of the Company. Any unauthorized alteration, copying or falsification of the content or appearance of this document is unlawful and offenders may be prosecuted to the fullest extent of the law. Unless otherwise stated the results shown in this test report are only for the samples tested and each sample is analysed for 100 days only.

F052 Version4

SGS Korea Co., Ltd.

322, The O valley, 555-9, Hoggae-dong, Dongan-gu, Anyang-si, Gyeonggi-do, Korea 431-060
t+82 (0)31 4608 000 f+82 (0)31 4608 050 <http://www.sgslab.co.kr> www.sgs.com/orenlab

Member of the SGS Group (Société Générale de Surveillance)

SGS
Test Report No. F690501/LF-CTSAYAA11-16099

Issued Date: May 24, 2011 Page 6 of 8

Substance Name	CAS number	EC number	Concentration (%)	Reporting Limit (%)	Classification
Cobalt(II) sulphate *	10124-43-3	233-334-2	N.D.	0.005	Carcinogen Category 2; Toxic to Reproduction Category 2
Cobalt(II) dinitrate *	10141-05-6	233-402-1	N.D.	0.005	Carcinogen Category 2; Toxic to Reproduction Category 2
Cobalt(II) carbonate *	513-79-1	208-169-4	N.D.	0.005	Carcinogen Category 2; Toxic to Reproduction Category 2
Cobalt(II) diacetate *	71-48-7	200-755-8	N.D.	0.005	Carcinogen Category 2; Toxic to Reproduction Category 2
2-Methoxyethanol	109-86-4	203-713-7	N.D.	0.05	Toxic to Reproduction Category 2
2-Ethoxyethanol	110-80-5	203-804-1	N.D.	0.05	Toxic to Reproduction Category 2
Chromium trioxide ^	1333-82-0	215-607-8	N.D.	0.005	Carcinogen Category 1; Mutagen Category 2
Acids generated from chromium trioxide and their oligomers:					
Chromic acid	7738-94-5	231-801-5	N.D.	0.005	Carcinogen Category 2
Dichromic acid	13530-68-2	236-881-5			
Oligomers of chromic acid and dichromic acid ^	-	-			

This document is issued by the Company, subject to its General Conditions of Service printed overleaf, available on request or accessible at www.sgs.com, and, for electronic format documents, subject to Terms and Conditions for Electronic Documents at www.sgs.com/led. Results are drawn to the attention of the Client, and are not intended to constitute a warranty. Any holder of this document or beneficiary thereof who obtains, in whole or in part, the Company's findings in the form of its information only and within the limit of Client's instructions, if any. The Company's sole responsibility is to its Client and the document does not constitute a warranty or a transaction from which all their rights and obligations under the transaction documents. This document cannot be reproduced or copied in full, without prior written approval of the Company. Any unauthorized alteration, forgery or falsification of the content or appearance of this document is unlawful and offenders may be prosecuted to the fullest extent of the law. Unless otherwise stated the results shown in this test report are only for the samples tested and each sample is analysed for 100 days only.

F052 Version4

SGS Korea Co., Ltd.

322, The O valley, 555-0, Hoggae-dong, Dongan-gu, Anyang-si, Gyeonggi-do, Korea 431-060
 t+82 (0)31 4608 000 f+82 (0)31 4608 050 <http://www.sgslab.co.kr> www.kr.sgs.com/kr/en/lab

Member of the SGS Group (Société Générale de Surveillance)



Test Report No. F690501/LF-CTSAYAA11-16099 Issued Date: May 24, 2011 Page 7 of 8

Note:

1. RL = Reporting Limit
2. ND = Not detected (lower than RL)

NA = Not applicable for respective material type.

The submitted sample was found to contain significant amount of specific element(s) of SVHC. Upon further test verification and also information provided from client, the possibility that the element(s) content originate from SVHC is very unlikely, even though their presence cannot be exclude entirely. It may be assumed that the detected element(s) have a non-SVHC source.

- 3.. *.The test result is based on the calculation of selected element(s) / marker(s) and to the worst-case scenario. For detail information, please refer to the SGS REACH website: www.reach.sgs.com/substance-of-very-high-concern-analysis-information-page.htm

* Calculated concentration of boric acid, disodium tetraborate, anhydrous and tetraboron disodium heptaoxide, hydrate are based on the total/water extractive boron by ICP-OES. Calculated concentrations of cobalt(II) sulphate, cobalt(II) dinitrate, cobalt(II) carbonate, cobalt(II) diacetate are based on the total/water extractive cobalt by ICP-OES.

^ Calculated concentrations of chromium trioxide, chromic acid and dichromic acid are based on the identified chromium(VI) by UV-Vis.

4. Test result of anthracene oil and coal tar are calculated as per selected identifiers of the SVHC. The value is reported in aggregate per anthracene oil or coal tar and based on the worst-case scenario.
5. 0.1% (w/w) = 1,000 ppm = 1,000 mg/kg



*** End of Report ***

This document is issued by the Company, subject to its General Conditions of Service printed overleaf, available on request or accessible at www.sgs.com, and, for electronic format documents, subject to Terms and Conditions for Electronic Documents at www.sgs.com/etd. Any test is done in the location of testing, identification or accreditation issued defined therein. Any holder of this document or holder of this information obtained herein releases the Company's liability in the event of its inaccuracy only and within the limit of Client's instructions, if any. The Company's sole responsibility is to its Client and the document does not constitute advice to a transaction from involving all their rights and obligations under the transaction documents. This document cannot be reproduced except in full, without prior written approval of the Company. Any unauthorized alteration, forgery or falsification of the content or appearance of this document is unlawful and offenders may be prosecuted to the fullest extent of the law. Unless otherwise stated the results shown in this test report are only for the samples tested and such samples are retained for 90 days only.

F052 Version4

SGS Korea Co., Ltd.

322, The O valley, 555-9, Hoggae-dong, Dongan-gu, Anyang-si, Gyeonggi-do, Korea 431-090
t +82 (0)31 4608 000 f +82 (0)31 4608 050 <http://www.sgslab.co.kr> www.kr.sgs.com/krenglish

Member of the SGS Group (Société Générale de Surveillance)



Test Report No. F690501/LF-CTSAYAA11-16099 Issued Date: May 24, 2011 Page 8 of 8

Appendix A

Classification	Definition under 67/548/EEC and Regulation (EC) No 1907/2006
Carcinogen Category 1:	<u>Substances known to be carcinogenic to man.</u> There is sufficient evidence to establish a causal association between human exposure to a substance and the development of cancer.
Carcinogen Category 2:	<u>Substances which should be regarded as if they are carcinogenic to man.</u> There is sufficient evidence to provide a strong presumption that human exposure to a substance may result in the development of cancer. Generally on the basis of: - appropriate long-term animal studies - other relevant information.
Mutagen Category 1:	<u>Substances known to be mutagenic to man.</u> There is sufficient evidence to establish a causal association between human exposure to a substance and heritable genetic damage.
Mutagen Category 2:	<u>Substances which should be regarded as if they are mutagenic to man.</u> There is sufficient evidence to provide a strong presumption that human exposure to the substance may result in the development of heritable genetic damage, generally on the basis of: - appropriate animal studies, - other relevant information.
Toxic to Reproduction Category 1:	<u>Substances known to impair fertility in humans.</u> There is sufficient evidence to establish a causal relationship between human exposure to the substance and impaired fertility. <u>Substances known to cause developmental toxicity in humans.</u> There is sufficient evidence to establish a causal relationship between human exposure to the substance and subsequent developmental toxic effects in the progeny.
Toxic to Reproduction Category 2:	<u>Substances which should be regarded as if they impair fertility in humans.</u> There is sufficient evidence to provide a strong presumption that human exposure to the substance may result in impaired fertility on the basis of: - clear evidence in animal studies of impaired fertility in the absence of toxic effects, or, evidence of impaired fertility occurring at around the same dose levels as other toxic effects but which is not a secondary nonspecific consequence of the other toxic effects, - other relevant information. <u>Substances which should be regarded as if they cause developmental toxicity to humans.</u> There is sufficient evidence to provide a strong presumption that human exposure to the substance may result in developmental toxicity, generally on the basis of: - clear results in appropriate animal studies where effects have been observed in the absence of signs of marked maternal toxicity, or at around the same dose levels as other toxic effects but which are not a secondary non-specific consequence of the other toxic effects, - other relevant information.
PBT & vPvB:	Substances which are persistent, bioaccumulative and toxic (PBT) or very persistent and very bioaccumulative (vPvB) pose a particular challenge to the chemicals safety management. For these substances a "safe" concentration in the environment cannot be established with sufficient reliability.

This document is issued by the Company, subject to its General Conditions of Service printed hereon, and also on request or accessible at www.sgs.com/termsandconditions and, for electronic format documents, subject to Terms and Conditions for Electronic Documents at www.sgs.com/termsandconditions. Analysis is drawn to the attention of liability, responsibility and jurisdiction issues defined therein. Any holder of this document or holder of the related material contained herein releases the Company's liability in the event of its transmission copy and within the limit of client's transactions, if any. The Company's sole responsibility is to its Client and the document does not constitute parties to a transaction from assuming all their rights and obligations under the transaction documents. This document cannot be reproduced or used in full without prior written approval of the Company. Any unauthorized alteration, forgery or falsification of the content or appearance of this document is unlawful and offenders may be prosecuted to the fullest extent of the law. Unless otherwise stated the results shown in this report refer only to the samples tested and such samples are retained for 90 days only.

F052 Version4

SGS Korea Co., Ltd.

322, The O valley, 555-9, Hoge-dong, Dongan-gu, Anyang-si, Gyeonggi-do, Korea 431-080
T+82 (0)31 4608 000 F+82 (0)31 4608 050 <http://www.sgslab.co.kr> www.kr.sgs.com/cn/en/lab

Member of the SGS Group (Société Générale de Surveillance)

