



## 2SB1188

### PNP SILICON TRANSISTOR

## MEDIUM POWER LOW VOLTAGE TRANSISTOR

### DESCRIPTION

The UTC 2SB1188 is a medium power low voltage transistor, designed for audio power amplifier, DC-DC converter and voltage regulator.

### FEATURES

- \*High current output up to 3A
- \*Low saturation voltage

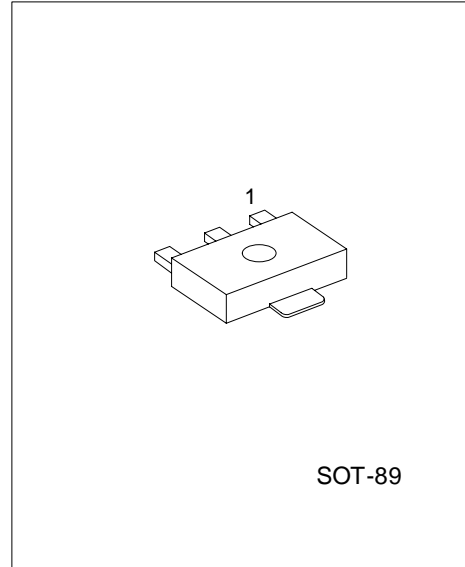

\*Pb-free plating product number: 2SB1188L

### ORDERING INFORMATION

Order Number		Package	Pin Assignment			Packing
Normal	Lead Free Plating		1	2	3	
2SB1188-x-AB3-R	2SB1188L-x-AB3-R	SOT-89	B	C	E	Tape Reel

<p>2SB1188L-x-AB3-R</p> <p>(1)Packing Type (2)Package Type (3)Rank (4)Lead Plating</p>	<p>(1) R: Tape Reel (2) AB3: SOT-89 (3) x: refer to Classification of <math>h_{FE2}</math> (4) L: Lead Free Plating, Blank: Pb/Sn</p>
--	---

■ ABSOLUTE MAXIMUM RATINGS (Ta = 25 °C)

PARAMETER	SYMBOL	RATINGS	UNIT
Collector -Base Voltage	$V_{CB0}$	-40	V
Collector -Emitter Voltage	$V_{CEO}$	-30	V
Emitter -Base Voltage	$V_{EBO}$	-5	V
Peak Collector Current	$I_{CM}$	-7	A
DC Collector Current	$I_C$	-3	A
Base Current	$I_B$	-0.6	A
Power Dissipation	$P_D$	0.5	W
Junction Temperature	$T_J$	+150	
Storage Temperature	$T_{STG}$	-40 ~ +150	

Note Absolute maximum ratings are those values beyond which the device could be permanently damaged.

Absolute maximum ratings are stress ratings only and functional device operation is not implied.

■ ELECTRICAL CHARACTERISTICS (Ta= 25 °C, unless otherwise specified)

PARAMETER	SYMBOL	TEST CONDITIONS	MIN	TYP	MAX	UNIT
Collector Cut-Off Current	$I_{CBO}$	$V_{CB}=-30V, I_E=0$			-1000	nA
Emitter Cut-Off Current	$I_{EBO}$	$V_{EB}=-3V, I_C=0$			-1000	nA
DC Current Gain(Note 1)	$h_{FE1}$	$V_{CE}=-2V, I_C=-20mA$	30	200		
	$h_{FE2}$	$V_{CE}=-2V, I_C=-1A$	100	150	400	
Collector-Emitter Saturation Voltage	$V_{CE(SAT)}$	$I_C=-2A, I_B=-0.2A$		-0.3	-0.5	V
Base-Emitter Saturation Voltage	$V_{BE(SAT)}$	$I_C=-2A, I_B=-0.2A$		-1.0	-2.0	V
Current Gain Bandwidth Product	$f_T$	$V_{CE}=-5V, I_C=-0.1A$		80		MHz
Output Capacitance	$C_{ob}$	$V_{CB}=-10V, I_E=0, f=1MHz$		45		pF

Note 1: Pulse test:  $P_W < 300\mu s$ , Duty Cycle  $< 2\%$

■ CLASSIFICATION OF  $h_{FE2}$

RANK	Q	P	E
RANGE	100 ~ 200	160 ~ 320	200 ~ 400

## TYPICAL CHARACTERISTICS

Fig.1 Static characteristics

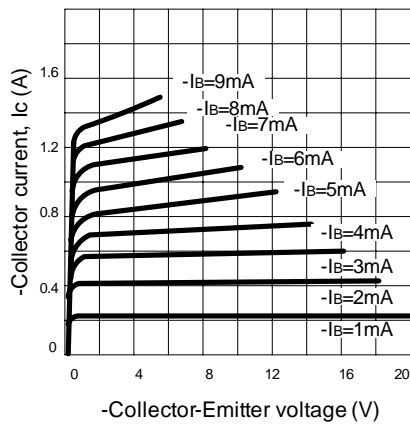

Fig.2 Derating curve of safe operating areas

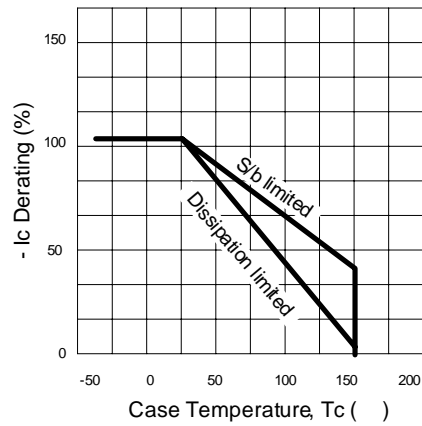

Fig.3 Power Derating

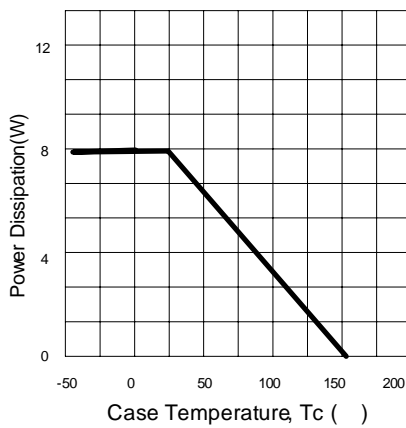

Fig.4 Collector Output capacitance

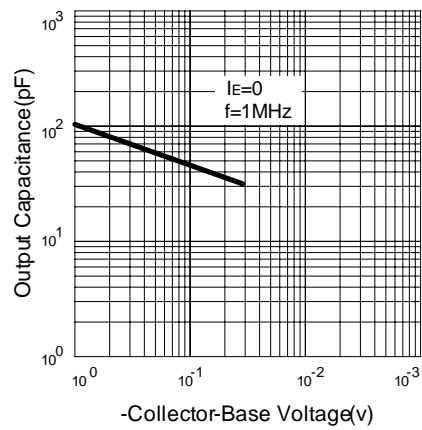

Fig.5 Current gain-bandwidth product

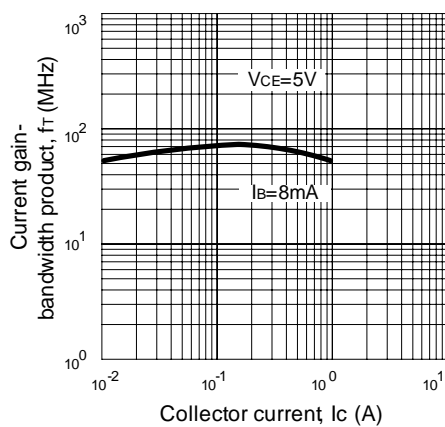
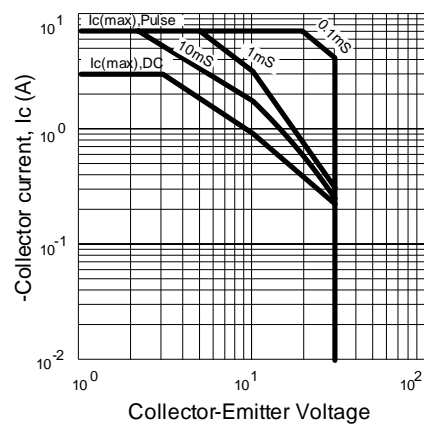

Fig.6 Safe Operating Area



■ TYPICAL CHARACTERISTICS(cont.)

Fig.7 DC current gain

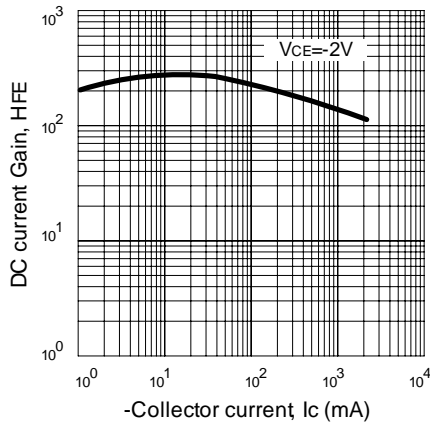
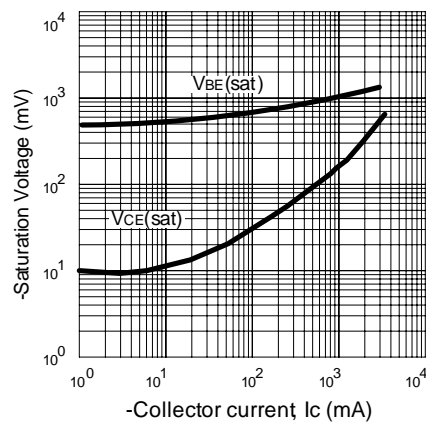

Fig.8 Saturation Voltage



UTC assumes no responsibility for equipment failures that result from using products at values that exceed, even momentarily, rated values (such as maximum ratings, operating condition ranges, or other parameters) listed in products specifications of any and all UTC products described or contained herein. UTC products are not designed for use in life support appliances, devices or systems where malfunction of these products can be reasonably expected to result in personal injury. Reproduction in whole or in part is prohibited without the prior written consent of the copyright owner. The information presented in this document does not form part of any quotation or contract, is believed to be accurate and reliable and may be changed without notice.