

FDMJ1023PZ

Dual P-Channel PowerTrench® MOSFET

-20V, -2.9A, 112mΩ

Features

- Max $r_{DS(on)}$ = 112mΩ at $V_{GS} = -4.5V$, $I_D = -2.9A$
- Max $r_{DS(on)}$ = 160mΩ at $V_{GS} = -2.5V$, $I_D = -2.4A$
- Max $r_{DS(on)}$ = 210mΩ at $V_{GS} = -1.8V$, $I_D = -2.1A$
- Max $r_{DS(on)}$ = 300mΩ at $V_{GS} = -1.5V$, $I_D = -1.0A$
- Low gate charge, high power and current handling capability
- HBM ESD protection level > 1.5kV typical (Note 3)
- RoHS Compliant



General Description

This dual P-Channel MOSFET uses Fairchild's advanced low voltage PowerTrench® process. This device is designed specifically as a single package solution for the battery charge switch in cellular handset and other ultra-portable applications. It features two independent P-Channel MOSFETs with low on-state resistance for minimum conduction losses. When connected in the typical common source configuration, bi-directional current flow is possible. The SC-75 MicroFET package offers exceptional thermal performance for its physical size and is well suited to linear mode applications.

Applications

- Battery management/charger application

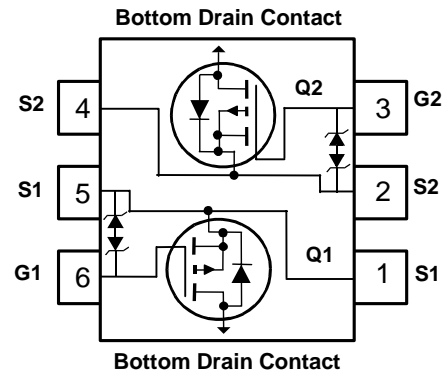
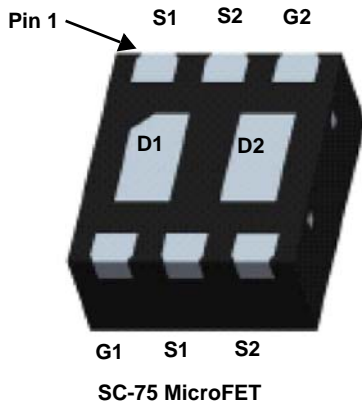

MOSFET Maximum Ratings $T_A = 25^\circ\text{C}$ unless otherwise noted

Symbol	Parameter	Ratings	Units
V_{DS}	Drain to Source Voltage	-20	V
V_{GS}	Gate to Source Voltage	±8	V
I_D	Drain Current -Continuous (Note 1a)	-2.9	A
	-Pulsed	-12	
P_D	Power Dissipation (Note 1a)	1.4	W
	Power Dissipation (Note 1b)	0.7	
T_J, T_{STG}	Operating and Storage Junction Temperature Range	-55 to +150	°C

Thermal Characteristics

$R_{\theta JA}$	Thermal Resistance, Junction to Ambient (Note 1a)	89	°C/W
$R_{\theta JA}$	Thermal Resistance, Junction to Ambient (Note 1b)	182	

Package Marking and Ordering Information

Device Marking	Device	Package	Reel Size	Tape Width	Quantity
023	FDMJ1023PZ	SC-75 MicroFET	7"	8mm	3000 units

Electrical Characteristics $T_J = 25^\circ\text{C}$ unless otherwise noted

Symbol	Parameter	Test Conditions	Min	Typ	Max	Units
--------	-----------	-----------------	-----	-----	-----	-------

Off Characteristics

BV_{DSS}	Drain to Source Breakdown Voltage	$I_D = -250\mu\text{A}, V_{GS} = 0\text{V}$	-20			V
$\frac{\Delta BV_{DSS}}{\Delta T_J}$	Breakdown Voltage Temperature Coefficient	$I_D = -250\mu\text{A}$, referenced to 25°C		-13		mV/ $^\circ\text{C}$
I_{DSS}	Zero Gate Voltage Drain Current	$V_{DS} = -16\text{V}, V_{GS} = 0\text{V}$			-1	μA
I_{GSS}	Gate to Source Leakage Current	$V_{GS} = \pm 8\text{V}, V_{DS} = 0\text{V}$			± 10	μA

On Characteristics

$V_{GS(th)}$	Gate to Source Threshold Voltage	$V_{GS} = V_{DS}, I_D = -250\mu\text{A}$	-0.4	-0.7	-1.0	V
$\frac{\Delta V_{GS(th)}}{\Delta T_J}$	Gate to Source Threshold Voltage Temperature Coefficient	$I_D = -250\mu\text{A}$, referenced to 25°C		2.3		mV/ $^\circ\text{C}$
$r_{DS(on)}$	Static Drain to Source On Resistance	$V_{GS} = -4.5\text{V}, I_D = -2.9\text{A}$		93	112	m Ω
		$V_{GS} = -2.5\text{V}, I_D = -2.4\text{A}$		128	160	
		$V_{GS} = -1.8\text{V}, I_D = -2.1\text{A}$		173	210	
		$V_{GS} = -1.5\text{V}, I_D = -1.0\text{A}$		217	300	
		$V_{GS} = -4.5\text{V}, I_D = -2.9\text{A}, T_J = 125^\circ\text{C}$		130	160	
g_{FS}	Forward Transconductance	$V_{DD} = -5\text{V}, I_D = -2.9\text{A}$		7		S

Dynamic Characteristics

C_{iss}	Input Capacitance	$V_{DS} = -10\text{V}, V_{GS} = 0\text{V}, f = 1\text{MHz}$		300	400	pF
C_{oss}	Output Capacitance			55	75	pF
C_{rss}	Reverse Transfer Capacitance			45	70	pF

Switching Characteristics

$t_{d(on)}$	Turn-On Delay Time	$V_{DD} = -10\text{V}, I_D = -2.9\text{A}, V_{GS} = -4.5\text{V}, R_{GEN} = 6\Omega$		5	10	ns
t_r	Rise Time			4	10	ns
$t_{d(off)}$	Turn-Off Delay Time			23	37	ns
t_f	Fall Time			12	22	ns
Q_g	Total Gate Charge		$V_{DD} = -5\text{V}, I_D = -2.9\text{A}, V_{GS} = -4.5\text{V}$		4.6	6.5
Q_{gs}	Gate to Source Charge			0.6		nC
Q_{gd}	Gate to Drain "Miller" Charge			1.0		nC

Drain-Source Diode Characteristics

I_S	Maximum Continuous Drain-Source Diode Forward Current			-1.1	A	
V_{SD}	Source to Drain Diode Forward Voltage	$V_{GS} = 0\text{V}, I_S = -1.1\text{A}$		-0.9	-1.2	V
t_{rr}	Reverse Recovery Time	$I_F = -2.9\text{A}, di/dt = 100\text{A}/\mu\text{s}$		28	45	ns
Q_{rr}	Reverse Recovery Charge			15	27	nC

Notes:

1. $R_{\theta JA}$ is determined with the device mounted on a 1in^2 pad 2 oz copper pad on a $1.5 \times 1.5\text{in.}$ board of FR-4 material. $R_{\theta JC}$ is guaranteed by design while $R_{\theta JA}$ is determined by the user's board design.



a. $89^\circ\text{C}/\text{W}$ when mounted on a 1in^2 pad of 2 oz copper



b. $182^\circ\text{C}/\text{W}$ when mounted on a minimum pad of 2 oz copper

2. Pulse Test: Pulse Width < $300\mu\text{s}$, Duty cycle < 2.0%.

3. The diode connected between the gate and source serves only as protection against ESD. No gate overvoltage rating is implied.

Typical Characteristics $T_J = 25^\circ\text{C}$ unless otherwise noted

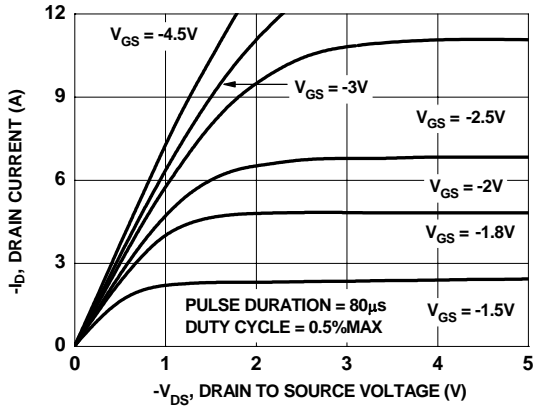

Figure 1. On-Region Characteristics

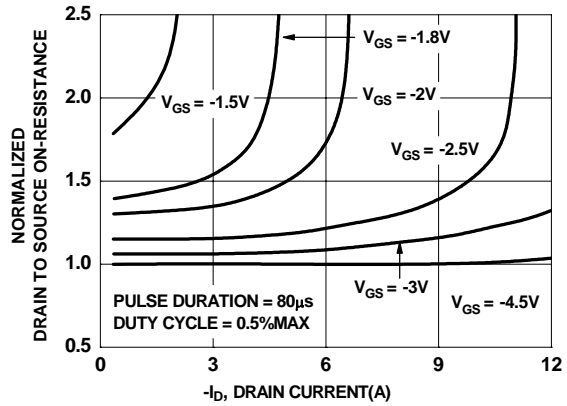

Figure 2. Normalized On-Resistance vs Drain Current and Gate Voltage

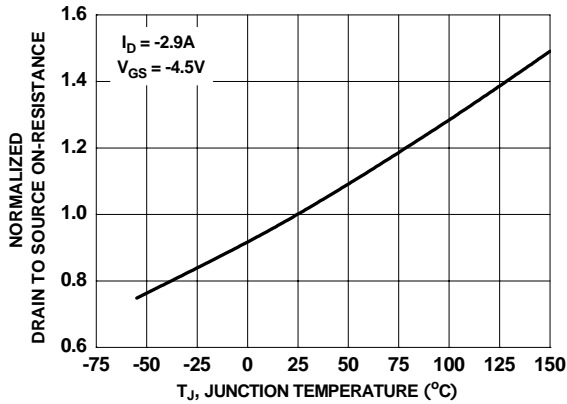

Figure 3. Normalized On-Resistance vs Junction Temperature

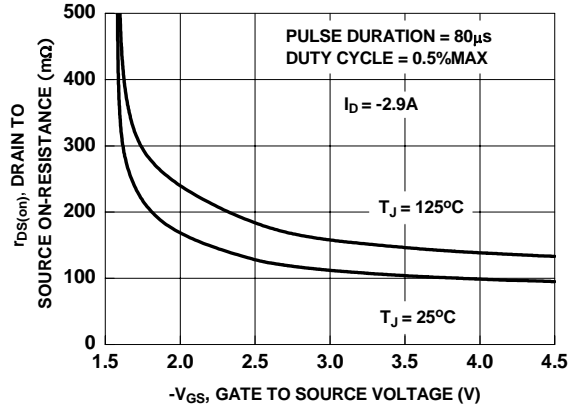

Figure 4. On-Resistance vs Gate to Source Voltage

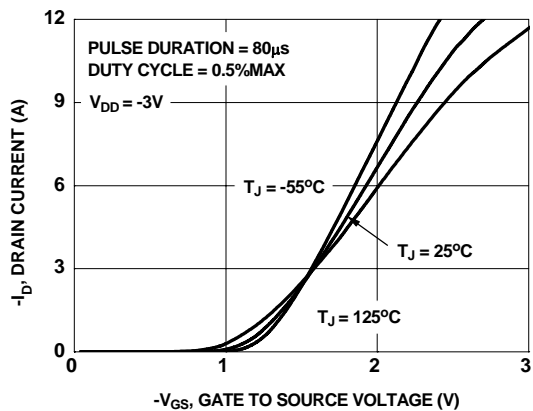

Figure 5. Transfer Characteristics

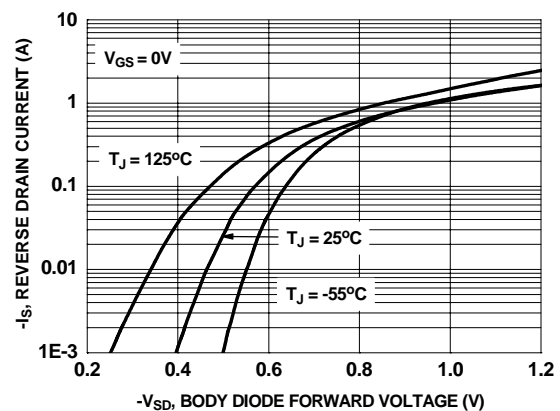

Figure 6. Source to Drain Diode Forward Voltage vs Source Current

Typical Characteristics $T_J = 25^\circ\text{C}$ unless otherwise noted

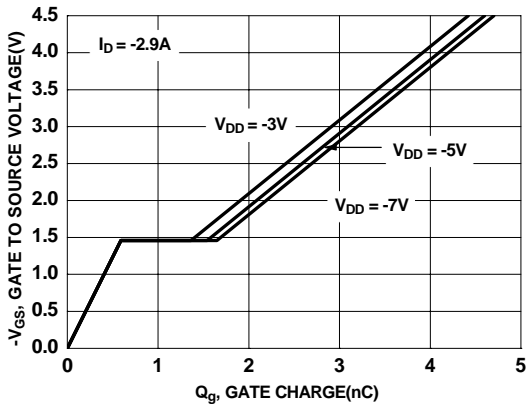

Figure 7. Gate Charge Characteristics

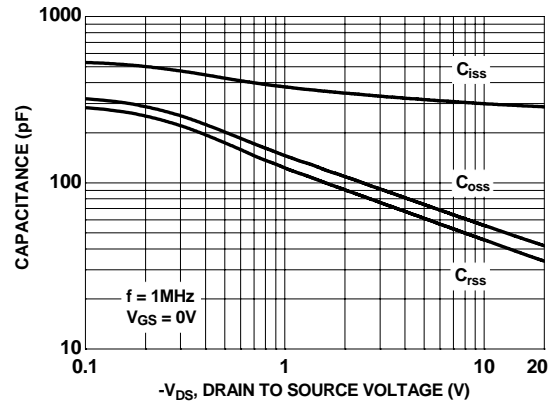

Figure 8. Capacitance vs Drain to Source Voltage

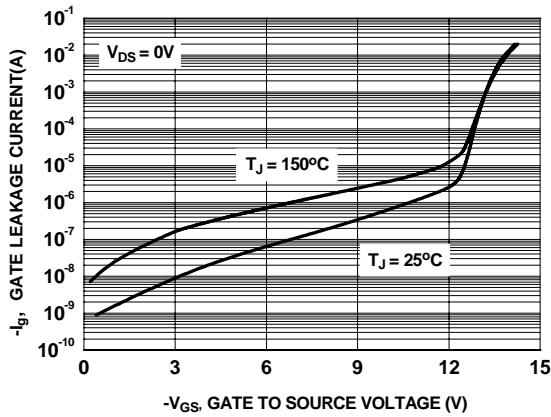

Figure 9. Gate Leakage Current vs Gate to Source Voltage

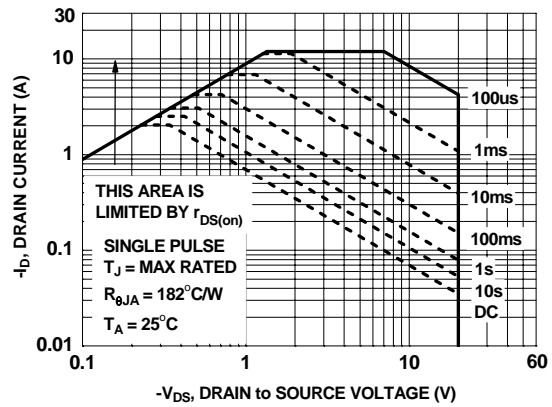

Figure 10. Forward Bias Safe Operating Area

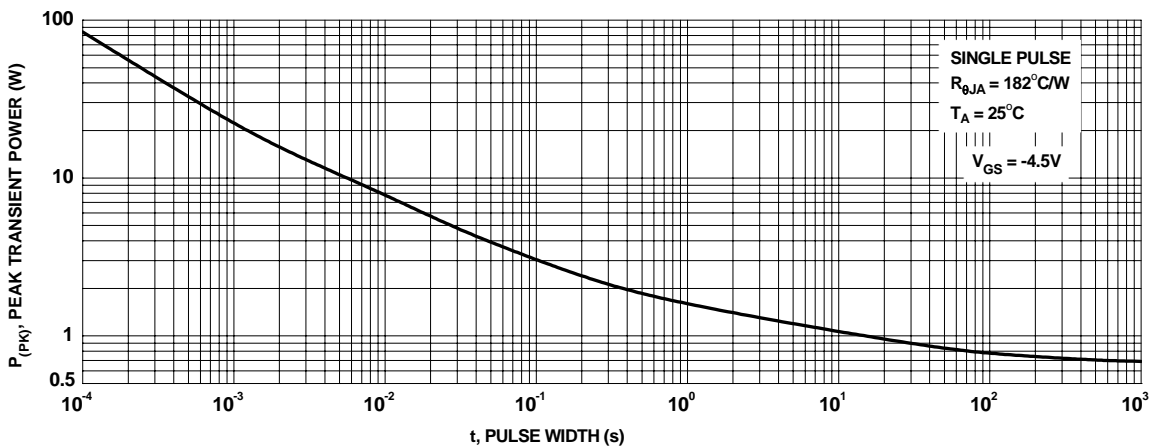

Figure 11. Single Pulse Maximum Power Dissipation

Typical Characteristics $T_J = 25^\circ\text{C}$ unless otherwise noted

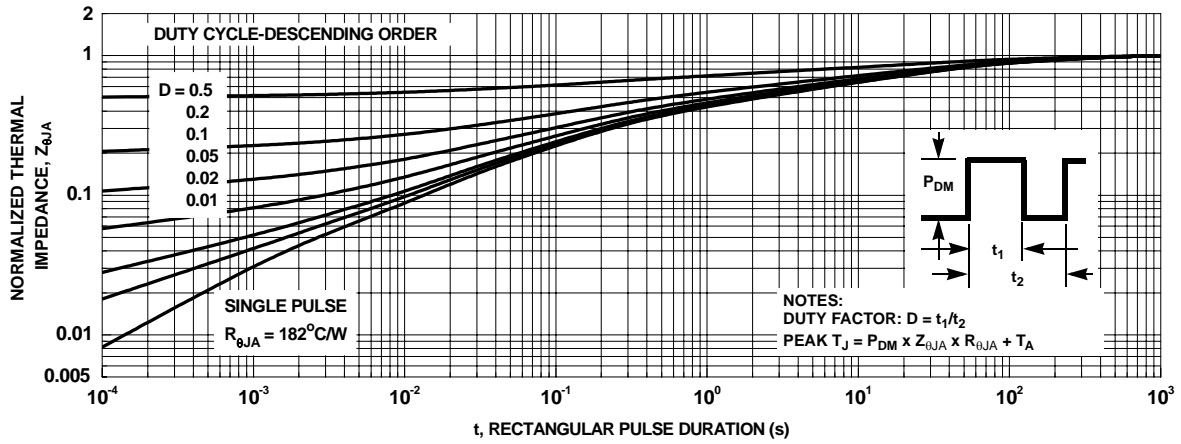
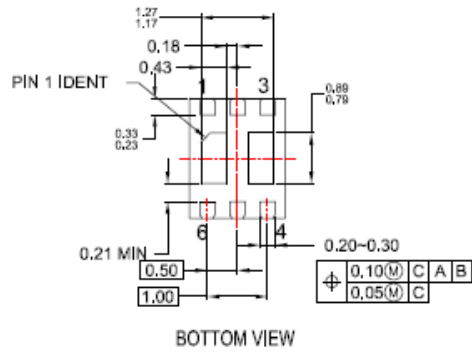
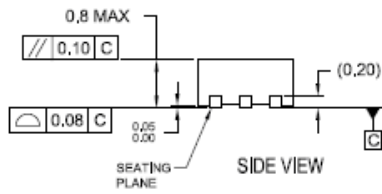
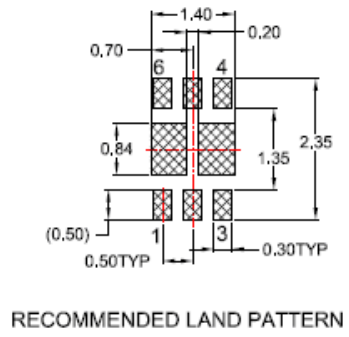
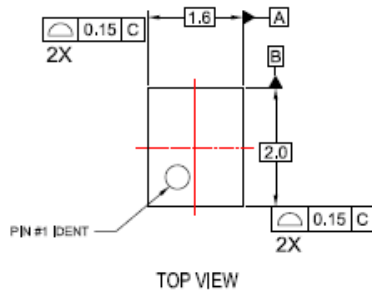

Figure 12. Transient Thermal Response Curve

Dimensional Outline and Pad Layout





TRADEMARKS

The following are registered and unregistered trademarks and service marks Fairchild Semiconductor owns or is authorized to use and is not intended to be an exhaustive list of all such trademarks.

ACEx [®]	Green FPS [™]	Power247 [®]	SuperSOT [™] -8
Build it Now [™]	Green FPS [™] e-Series [™]	POWEREDGE [®]	SyncFET [™]
CorePLUS [™]	GTO [™]	Power-SPM [™]	The Power Franchise [®]
CROSSVOLT [™]	<i>i-Lo</i> [™]	PowerTrench [®]	power the franchise
CTL [™]	IntelliMAX [™]	Programmable Active Droop [™]	TinyBoost [™]
Current Transfer Logic [™]	ISOPLANAR [™]	QFET [®]	TinyBuck [™]
EcoSPARK [®]	MegaBuck [™]	QST [™]	TinyLogic [®]
F [®]	MICROCOUPLER [™]	QT Optoelectronics [™]	TINYOPTO [™]
Fairchild [®]	MicroFET [™]	Quiet Series [™]	TinyPower [™]
Fairchild Semiconductor [®]	MicroPak [™]	RapidConfigure [™]	TinyPWM [™]
FACT Quiet Series [™]	MillerDrive [™]	SMART START [™]	TinyWire [™]
FACT [®]	Motion-SPM [™]	SPM [®]	μSerDes [™]
FAST [®]	OPTOLOGIC [®]	STEALTH [™]	UHC [®]
FastvCore [™]	OPTOPLANAR [®]	SuperFET [™]	UniFET [™]
FPS [™]	 [®]	SuperSOT [™] -3	VCX [™]
FRFET [®]	PDP-SPM [™]	SuperSOT [™] -6	
Global Power Resource SM	Power220 [®]		

DISCLAIMER

FAIRCHILD SEMICONDUCTOR RESERVES THE RIGHT TO MAKE CHANGES WITHOUT FURTHER NOTICE TO ANY PRODUCTS HEREIN TO IMPROVE RELIABILITY, FUNCTION, OR DESIGN. FAIRCHILD DOES NOT ASSUME ANY LIABILITY ARISING OUT OF THE APPLICATION OR USE OF ANY PRODUCT OR CIRCUIT DESCRIBED HEREIN; NEITHER DOES IT CONVEY ANY LICENSE UNDER ITS PATENT RIGHTS, NOR THE RIGHTS OF OTHERS. THESE SPECIFICATIONS DO NOT EXPAND THE TERMS OF FAIRCHILD'S WORLDWIDE TERMS AND CONDITIONS, SPECIFICALLY THE WARRANTY THEREIN, WHICH COVERS THESE PRODUCTS.

LIFE SUPPORT POLICY

FAIRCHILD'S PRODUCTS ARE NOT AUTHORIZED FOR USE AS CRITICAL COMPONENTS IN LIFE SUPPORT DEVICES OR SYSTEMS WITHOUT THE EXPRESS WRITTEN APPROVAL OF FAIRCHILD SEMICONDUCTOR CORPORATION.

As used herein:

1. Life support devices or systems are devices or systems which, (a) are intended for surgical implant into the body or (b) support or sustain life, and (c) whose failure to perform when properly used in accordance with instructions for use provided in the labeling, can be reasonably expected to result in a significant injury to the user.
2. A critical component in any component of a life support, device, or system whose failure to perform can be reasonably expected to cause the failure of the life support device or system, or to affect its safety or effectiveness.

PRODUCT STATUS DEFINITIONS

Definition of Terms

Datasheet Identification	Product Status	Definition
Advance Information	Formative or In Design	This datasheet contains the design specifications for product development. Specifications may change in any manner without notice.
Preliminary	First Production	This datasheet contains preliminary data; supplementary data will be published at a later date. Fairchild Semiconductor reserves the right to make changes at any time without notice to improve design.
No Identification Needed	Full Production	This datasheet contains final specifications. Fairchild Semiconductor reserves the right to make changes at any time without notice to improve design.
Obsolete	Not In Production	This datasheet contains specifications on a product that has been discontinued by Fairchild Semiconductor. The datasheet is printed for reference information only.

Rev. I31