



Micro Commercial Components  
 21201 Itasca Street Chatsworth  
 CA 91311  
 Phone: (818) 701-4933  
 Fax: (818) 701-4939

# ES2A THRU ES2M

## Features

- For Surface Mount Applications
- Extremely Low Thermal Resistance
- Easy Pick And Place
- High Temp Soldering: 250°C for 10 Seconds At Terminals
- Superfast Recovery Times For High Efficiency

## Maximum Ratings

- Operating Temperature: -50°C to +150°C
- Storage Temperature: -50°C to +150°C
- Maximum Thermal Resistance; 20°C/W Junction To Lead

MCC Catalog Number	Device Marking	Maximum Recurrent Peak Reverse Voltage	Maximum RMS Voltage	Maximum DC Blocking Voltage
ES2A	ES2A	50V	35V	50V
ES2B	ES2B	100V	70V	100V
ES2C	ES2C	150V	105V	150V
ES2D	ES2D	200V	140V	200V
ES2G	ES2G	400V	280V	400V
ES2J	ES2J	600V	420V	600V
ES2K	ES2K	800V	560V	800V
ES2M	ES2M	1000V	700V	1000V

## Electrical Characteristics @ 25°C Unless Otherwise Specified

Average Forward Current	$I_{F(AV)}$	2.0A	$T_J = 75^\circ\text{C}$
Peak Forward Surge Current	$I_{FSM}$	50A	8.3ms, half sine
Maximum Instantaneous Forward Voltage	$V_F$	ES2A-D ES2G-K ES2M 0.975V 1.35V 1.60V	$I_{FM} = 2.0\text{A};$ $T_J = 25^\circ\text{C}^*$
Maximum DC Reverse Current At Rated DC Blocking Voltage	$I_R$	5 $\mu\text{A}$ 150 $\mu\text{A}$	$T_J = 25^\circ\text{C}$ $T_J = 100^\circ\text{C}$
Maximum Reverse Recovery Time	$T_{rr}$	50ns 60ns 100ns	$I_F=0.5\text{A}, I_R=1.0\text{A},$ $I_{rr}=0.25\text{A}$
Typical Junction Capacitance	$C_J$	25pF	Measured at 1.0MHz, $V_R=4.0\text{V}$

\*Pulse test: Pulse width 200  $\mu\text{sec}$ , Duty cycle 2%

## 2 Amp Super Fast Recovery Silicon Rectifier 50 to 1000 Volts

### DO-214AC (SMAJ) (High Profile)

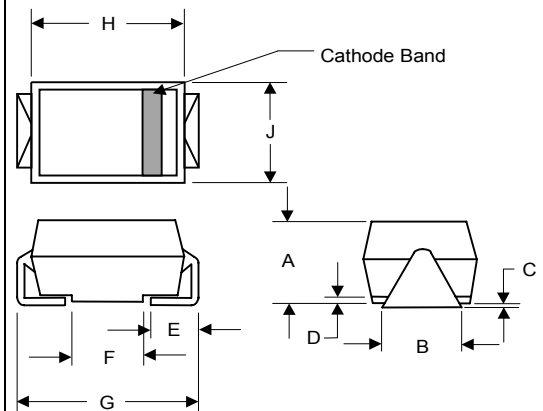

DIM	INCHES		MM		NOTE
	MIN	MAX	MIN	MAX	
A	.078	.116	1.98	2.95	
B	.067	.089	1.70	2.25	
C	.002	.008	.05	.20	
D	—	.02	—	.51	
E	.035	.055	.89	1.40	
F	.065	.096	1.65	2.45	
G	.205	.224	5.21	5.69	
H	.160	.180	4.06	4.57	
J	.100	.112	2.57	2.84	

### SUGGESTED SOLDER PAD LAYOUT

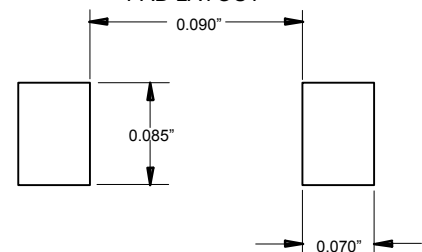
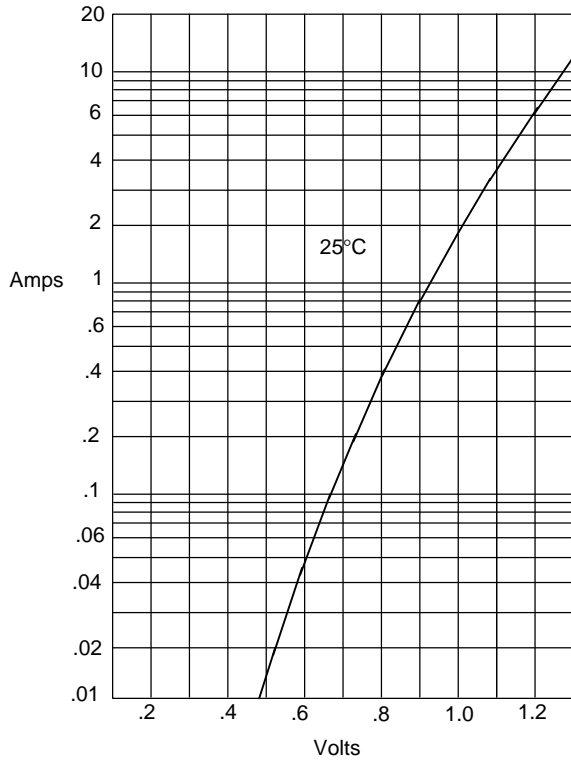
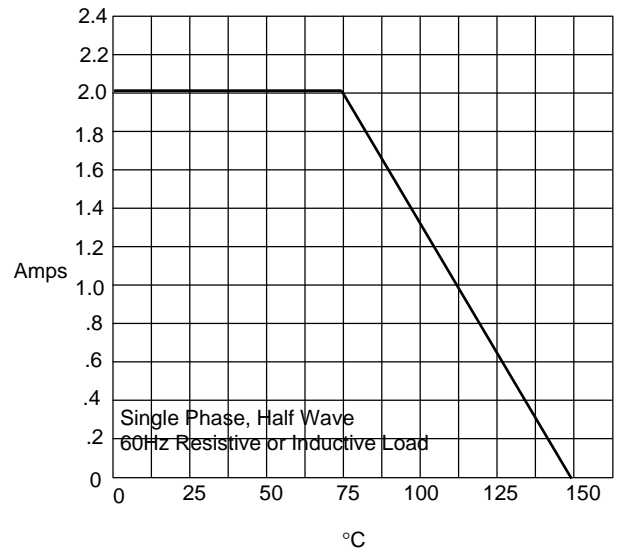

Figure 1  
Typical Forward Characteristics



Instantaneous Forward Current - Amperes versus  
Instantaneous Forward Voltage - Volts

Figure 2  
Forward Derating Curve



Average Forward Rectified Current - Amperes versus  
Ambient Temperature - °C

Figure 3  
Junction Capacitance

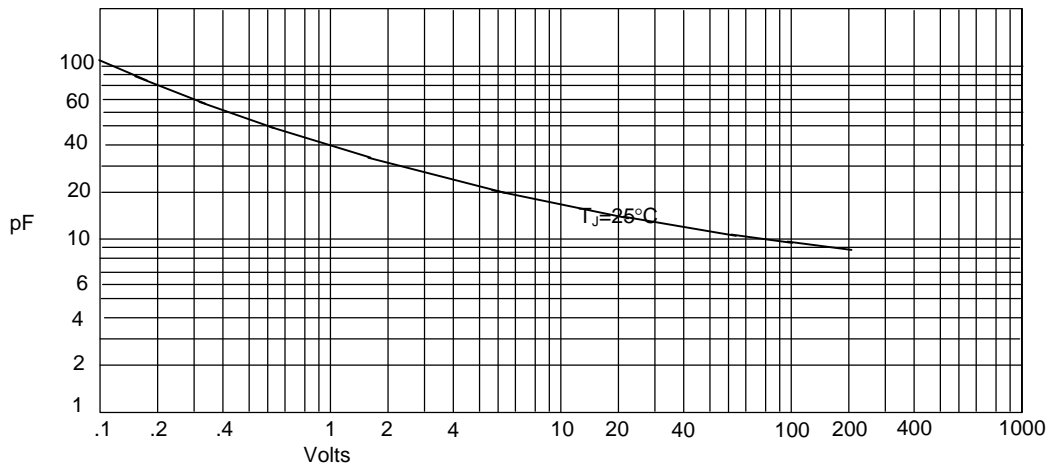

Junction Capacitance - pF versus  
Reverse Voltage - Volts

# ES2A thru ES2M



Figure 4  
Peak Forward Surge Current

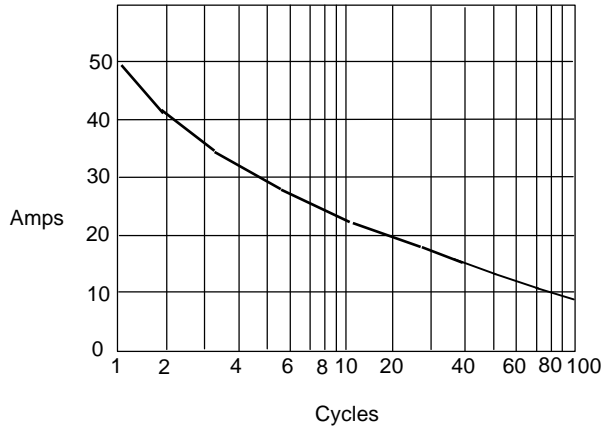

Peak Forward Surge Current - Amperes versus  
Number Of Cycles At 60Hz - Cycles

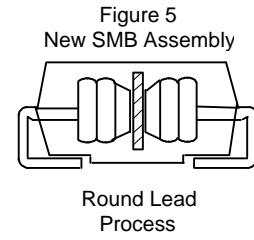
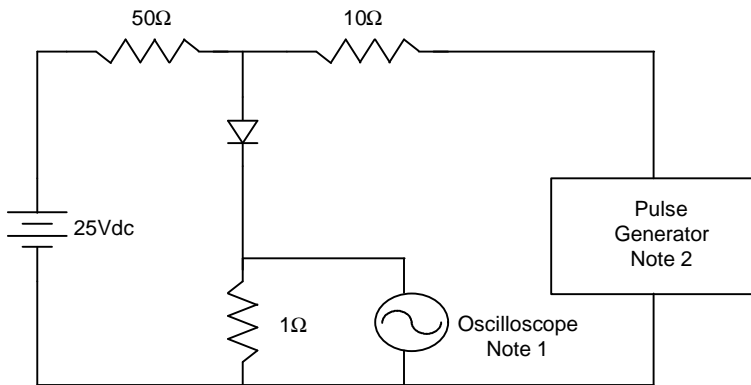

Figure 6  
Reverse Recovery Time Characteristic And Test Circuit Diagram



- Notes:
1. Rise Time = 7ns max.  
Input impedance = 1 megohm, 22pF
  2. Rise Time = 10ns max.  
Source impedance = 50 ohms
  3. Resistors are non-inductive

