

## Cap-Free, NMOS, 150mA Low Dropout Regulator with Reverse Current Protection

### FEATURES

- Stable with No Output Capacitor or Any Value or Type of Capacitor
- Input Voltage Range of 1.7V to 5.5V
- Ultralow Dropout Voltage: 30mV Typ
- Excellent Load Transient Response—with or without Optional Output Capacitor
- New NMOS Topology Provides Low Reverse Leakage Current
- Low Noise:  $30\mu\text{V}_{\text{RMS}}$  Typ (10kHz to 100kHz)
- 0.5% Initial Accuracy
- 1% Overall Accuracy over Line, Load, and Temperature
- Less Than  $1\mu\text{A}$  Max  $I_{\text{Q}}$  in Shutdown Mode
- Thermal Shutdown and Specified Min/Max Current Limit Protection
- Available in Multiple Output Voltage Versions
  - Fixed Outputs of 1.2V, 1.5V, 1.8V, 2.5V, 3.0V, 3.3V, and 5.0V
  - Adjustable Outputs From 1.20V to 5.5V
  - Custom Outputs Available

### APPLICATIONS

- Portable/Battery-Powered Equipment
- Post-Regulation for Switching Supplies
- Noise-Sensitive Circuitry such as VCOs
- Point of Load Regulation for DSPs, FPGAs, ASICs, and Microprocessors

### DESCRIPTION

The TPS731xx family of low-dropout (LDO) linear voltage regulators uses a new topology: an NMOS pass element in a voltage-follower configuration. This topology is stable using output capacitors with low ESR, and even allows operation without a capacitor. It also provides high reverse blockage (low reverse current) and ground pin current that is nearly constant over all values of output current.

The TPS731xx uses an advanced BiCMOS process to yield high precision while delivering very low dropout voltages and low ground pin current. Current consumption, when not enabled, is under  $1\mu\text{A}$  and ideal for portable applications. The extremely low output noise ( $30\mu\text{V}_{\text{RMS}}$  with  $0.1\mu\text{F}$   $C_{\text{NR}}$ ) is ideal for powering VCOs. These devices are protected by thermal shutdown and foldback current limit.

DBV PACKAGE  
SOT23  
(TOP VIEW)

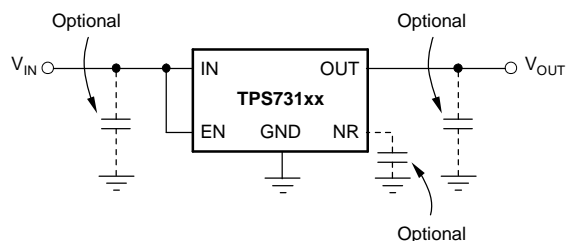
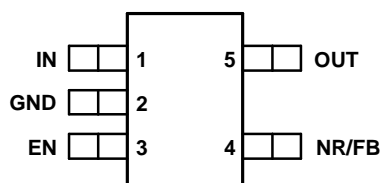

Typical Application Circuit for Fixed-Voltage Versions



Please be aware that an important notice concerning availability, standard warranty, and use in critical applications of Texas Instruments semiconductor products and disclaimers thereto appears at the end of this data sheet.



This integrated circuit can be damaged by ESD. Texas Instruments recommends that all integrated circuits be handled with appropriate precautions. Failure to observe proper handling and installation procedures can cause damage.

ESD damage can range from subtle performance degradation to complete device failure. Precision integrated circuits may be more susceptible to damage because very small parametric changes could cause the device not to meet its published specifications.

### ORDERING INFORMATION

PRODUCT	V <sub>OUT</sub> <sup>(1)</sup>	PACKAGE-LEAD (DESIGNATOR) <sup>(2)</sup>	SPECIFIED TEMPERATURE RANGE	PACKAGE MARKING	ORDERING NUMBER	TRANSPORT MEDIA, QUANTITY
TPS73101	Adjustable or 1.2V <sup>(3)</sup>	SOT23-5 (DBV)	-40°C to +125°C	PWYQ	TPS73101DBVT	Tape and Reel, 250
					TPS73101DBVR	Tape and Reel, 3000
TPS73115	1.5V	SOT23-5 (DBV)	-40°C to +125°C	T31	TPS73115DBVT	Tape and Reel, 250
					TPS73115DBVR	Tape and Reel, 3000
TPS73118	1.8V	SOT23-5 (DBV)	-40°C to +125°C	T32	TPS73118DBVT	Tape and Reel, 250
					TPS73118DBVR	Tape and Reel, 3000
TPS73125	2.5V	SOT23-5 (DBV)	-40°C to +125°C	PHWI	TPS73125DBVT	Tape and Reel, 250
					TPS73125DBVR	Tape and Reel, 3000
TPS73130	3.0V	SOT23-5 (DBV)	-40°C to +125°C	T33	TPS73130DBVT	Tape and Reel, 250
					TPS73130DBVR	Tape and Reel, 3000
TPS73132	3.2V	SOT23-5 (DBV)	-40°C to +125°C	T52	TPS73132DBVT	Tape and Reel, 250
					TPS73132DBVR	Tape and Reel, 3000
TPS73133	3.3V	SOT23-5 (DBV)	-40°C to +125°C	T34	TPS73133DBVT	Tape and Reel, 250
					TPS73133DBVR	Tape and Reel, 3000
TPS73150	5.0V	SOT23-5 (DBV)	-40°C to +125°C	T35	TPS73150DBVT	Tape and Reel, 250
					TPS73150DBVR	Tape and Reel, 3000

- (1) Custom output voltages from 1.3V to 4V in 100mV increments are available on a quick-turn basis for prototyping. Minimum order quantities apply; contact factory for details and availability.
- (2) For the most current specification and package information, refer to the Package Option Addendum located at the end of this datasheet.
- (3) For fixed 1.2V operation, tie FB to OUT.

### ABSOLUTE MAXIMUM RATINGS

over operating junction temperature range unless otherwise noted<sup>(1)</sup>

	TPS731xx	UNIT
V <sub>IN</sub> range	-0.3 to 6.0	V
V <sub>EN</sub> range	-0.3 to 6.0	V
V <sub>OUT</sub> range	-0.3 to 5.5	V
Peak output current	Internally limited	
Output short-circuit duration	Indefinite	
Continuous total power dissipation	See Dissipation Ratings Table	
Junction temperature range, T <sub>J</sub>	-55 to +150	°C
Storage temperature range	-65 to +150	°C
ESD rating, HBM	2	kV
ESD rating, CDM	500	V

- (1) Stresses beyond those listed under *absolute maximum ratings* may cause permanent damage to the device. These are stress ratings only, and functional operation of the device at these or any other conditions beyond those indicated under the Electrical Characteristics is not implied. Exposure to absolute maximum rated conditions for extended periods may affect device reliability.

## POWER DISSIPATION RATINGS<sup>(1)</sup>

BOARD	PACKAGE	R <sub>θJC</sub>	R <sub>θJA</sub>	DERATING FACTOR ABOVE T <sub>A</sub> = 25°C	T <sub>A</sub> ≤ 25°C POWER RATING	T <sub>A</sub> = 70°C POWER RATING	T <sub>A</sub> = 85°C POWER RATING
Low-K <sup>(2)</sup>	DBV	64°C/W	255°C/W	3.9mW/°C	390mW	215mW	155mW
High-K <sup>(3)</sup>	DBV	64°C/W	180°C/W	5.6mW/°C	560mW	310mW	225mW

- (1) See *Power Dissipation* in the **Applications** section for more information related to thermal design.  
 (2) The JEDEC Low-K (1s) board design used to derive this data was a 3 inch x 3 inch, two-layer board with 2-ounce copper traces on top of the board.  
 (3) The JEDEC High-K (2s2p) board design used to derive this data was a 3 inch x 3 inch, multilayer board with 1-ounce internal power and ground planes and 2-ounce copper traces on the top and bottom of the board.

## ELECTRICAL CHARACTERISTICS

Over operating temperature range (T<sub>J</sub> = -40°C to +125°C), V<sub>IN</sub> = V<sub>OUT(nom)</sub> + 0.5V<sup>(1)</sup>, I<sub>OUT</sub> = 10mA, V<sub>EN</sub> = 1.7V, and C<sub>OUT</sub> = 0.1μF, unless otherwise noted. Typical values are at T<sub>J</sub> = 25°C.

PARAMETER		TEST CONDITIONS	MIN	TYP	MAX	UNIT
V <sub>IN</sub>	Input voltage range <sup>(1)</sup>		1.7		5.5	V
V <sub>FB</sub>	Internal reference (TPS73101)	T <sub>J</sub> = 25°C	1.198	1.20	1.210	V
V <sub>OUT</sub>	Output voltage range (TPS73101)		V <sub>FB</sub>		5.5 - V <sub>DO</sub>	V
	Accuracy <sup>(1)</sup>	Nominal T <sub>J</sub> = 25°C V <sub>OUT</sub> + 0.5V ≤ V <sub>IN</sub> ≤ 5.5V; 10 mA ≤ I <sub>OUT</sub> ≤ 150mA	-0.5	±0.5	+0.5	%
ΔV <sub>OUT</sub> %/ΔV <sub>IN</sub>	Line regulation <sup>(1)</sup>	V <sub>OUT(nom)</sub> + 0.5V ≤ V <sub>IN</sub> ≤ 5.5V		0.01		%/V
ΔV <sub>OUT</sub> %/ΔI <sub>OUT</sub>	Load regulation	1mA ≤ I <sub>OUT</sub> ≤ 150mA		0.002		%mA
		10mA ≤ I <sub>OUT</sub> ≤ 150mA		0.0005		
V <sub>DO</sub>	Dropout voltage <sup>(2)</sup> (V <sub>IN</sub> = V <sub>OUT(nom)</sub> - 0.1V)	I <sub>OUT</sub> = 150mA		30	100	mV
Z <sub>O(DO)</sub>	Output impedance in dropout	1.7 V ≤ V <sub>IN</sub> ≤ V <sub>OUT</sub> + V <sub>DO</sub>		0.25		Ω
I <sub>CL</sub>	Output current limit	V <sub>OUT</sub> = 0.9 × V <sub>OUT(nom)</sub>	150	360	500	mA
I <sub>SC</sub>	Short-circuit current	V <sub>OUT</sub> = 0V		200		mA
I <sub>REV</sub>	Reverse leakage current <sup>(3)</sup> (-I <sub>IN</sub> )	V <sub>EN</sub> ≤ 0.5V, 0V ≤ V <sub>IN</sub> ≤ V <sub>OUT</sub>		0.1	10	μA
I <sub>GND</sub>	Ground pin current	I <sub>OUT</sub> = 10mA (I <sub>Q</sub> )		400	550	μA
		I <sub>OUT</sub> = 150mA		550	750	
I <sub>SHDN</sub>	Shutdown current (I <sub>GND</sub> )	V <sub>EN</sub> ≤ 0.5V, V <sub>OUT</sub> ≤ V <sub>IN</sub> ≤ 5.5		0.02	1	μA
I <sub>FB</sub>	FB pin current (TPS73101)			0.1	0.3	μA
PSRR	Power-supply rejection ratio (ripple rejection)	f = 100Hz, I <sub>OUT</sub> = 150 mA		58		dB
		f = 10kHz, I <sub>OUT</sub> = 150 mA		37		
V <sub>N</sub>	Output noise voltage BW = 10Hz - 100kHz	C <sub>OUT</sub> = 10μF, No C <sub>NR</sub>		27 × V <sub>OUT</sub>		μV <sub>RMS</sub>
		C <sub>OUT</sub> = 10μF, C <sub>NR</sub> = 0.01μF		8.5 × V <sub>OUT</sub>		
t <sub>STR</sub>	Startup time	V <sub>OUT</sub> = 3V, R <sub>L</sub> = 30Ω C <sub>OUT</sub> = 1 μF, C <sub>NR</sub> = 0.01 μF		600		μs
V <sub>EN(HI)</sub>	Enable high (enabled)		1.7		V <sub>IN</sub>	V
V <sub>EN(LO)</sub>	Enable low (shutdown)		0		0.5	V
I <sub>EN(HI)</sub>	Enable pin current (enabled)	V <sub>EN</sub> = 5.5V		0.02	0.1	μA
T <sub>SD</sub>	Thermal shutdown temperature	Shutdown Temp increasing		160		°C
		Reset Temp decreasing		140		
T <sub>J</sub>	Operating junction temperature		-40		125	°C

- (1) Minimum V<sub>IN</sub> = V<sub>OUT</sub> + V<sub>DO</sub> or 1.7V, whichever is greater.  
 (2) V<sub>DO</sub> is not measured for the TPS73115 (V<sub>O(nom)</sub> = 1.5V) since minimum V<sub>IN</sub> = 1.7V.  
 (3) Fixed-voltage versions only; refer to the **Applications** section for more information.

FUNCTIONAL BLOCK DIAGRAMS

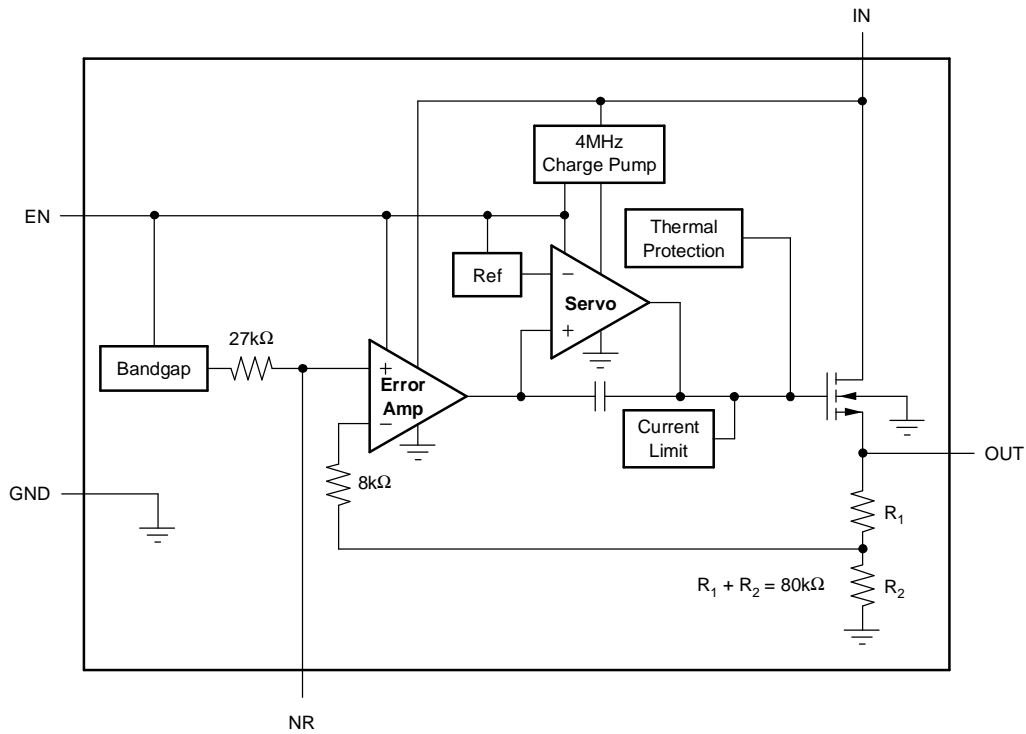

Figure 1. Fixed Voltage Version

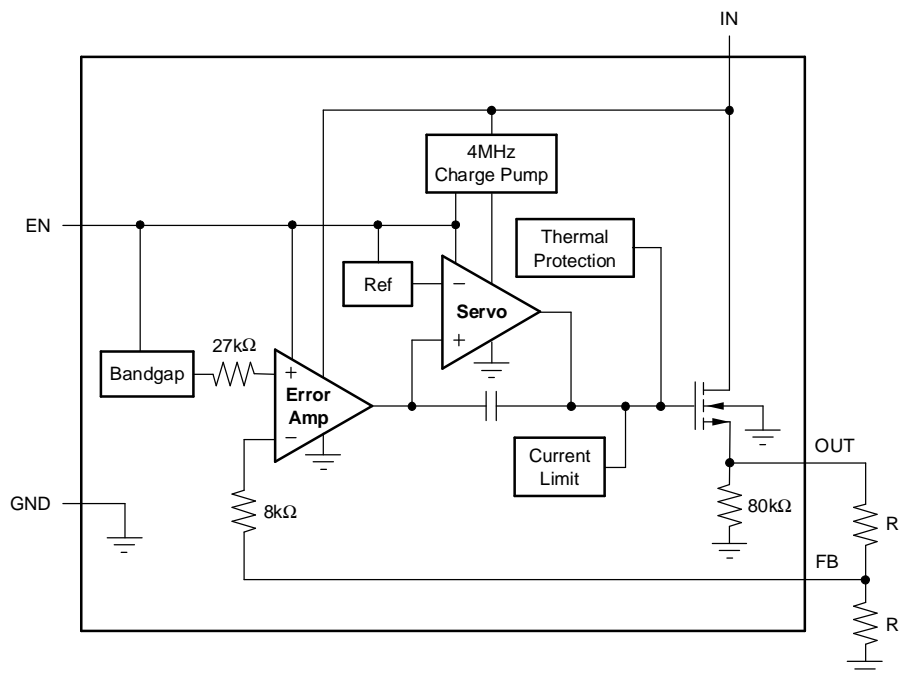

Figure 2. Adjustable Voltage Version

Table 1. Standard 1% Resistor Values for Common Output Voltages

V <sub>O</sub>	R <sub>1</sub>	R <sub>2</sub>
1.2V	Short	Open
1.5V	23.2kΩ	95.3kΩ
1.8V	28.0kΩ	56.2kΩ
2.5V	39.2kΩ	36.5kΩ
2.8V	44.2kΩ	33.2kΩ
3.0V	46.4kΩ	30.9kΩ
3.3V	52.3kΩ	30.1kΩ
5.0V	78.7kΩ	24.9kΩ

NOTE:  $V_{OUT} = (R_1 + R_2)/R_2 \times 1.204$ ;  
 $R_1 || R_2 \cong 19k\Omega$  for best accuracy.

## PIN ASSIGNMENTS

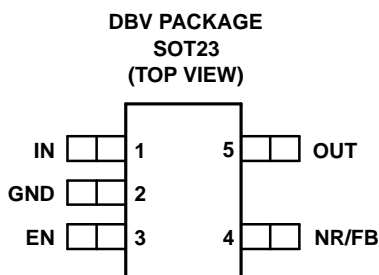

## TERMINAL FUNCTIONS

TERMINAL		DESCRIPTION
NAME	SOT23 (DBV) PIN NO.	
IN	1	Unregulated input supply
GND	2	Ground
EN	3	Driving the enable pin (EN) high turns on the regulator. Driving this pin low puts the regulator into shutdown mode. Refer to the Shutdown section under Applications Information for more details. EN can be connected to IN if not used.
NR	4	Fixed voltage versions only—connecting an external capacitor to this pin bypasses noise generated by the internal bandgap, reducing output noise to very low levels.
FB	4	Adjustable voltage version only—this is the input to the control loop error amplifier, and is used to set the output voltage of the device.
OUT	5	Output of the regulator. There are no output capacitor requirements for stability.

### TYPICAL CHARACTERISTICS

For all voltage versions at  $T_J = 25^\circ\text{C}$ ,  $V_{IN} = V_{OUT(nom)} + 0.5\text{V}$ ,  $I_{OUT} = 10\text{mA}$ ,  $V_{EN} = 1.7\text{V}$ , and  $C_{OUT} = 0.1\mu\text{F}$ , unless otherwise noted.

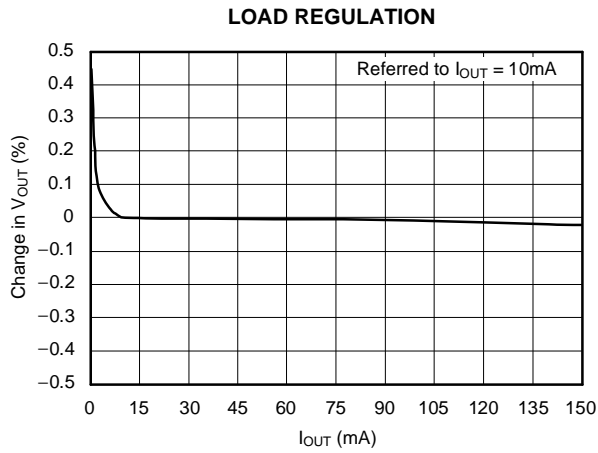

Figure 3.

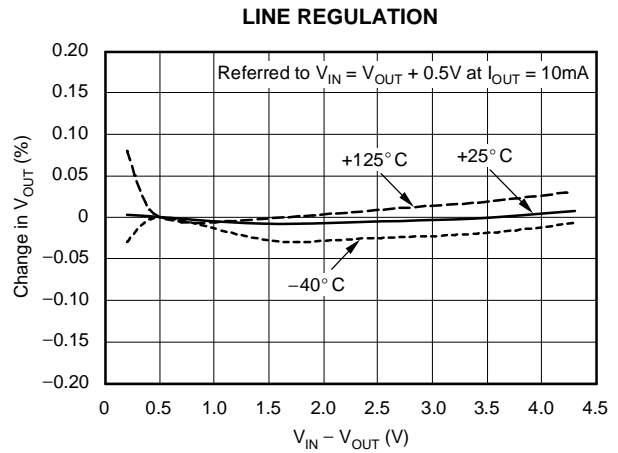

Figure 4.

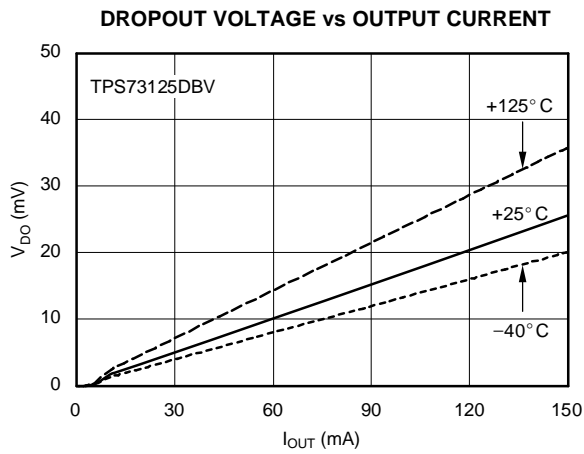

Figure 5.

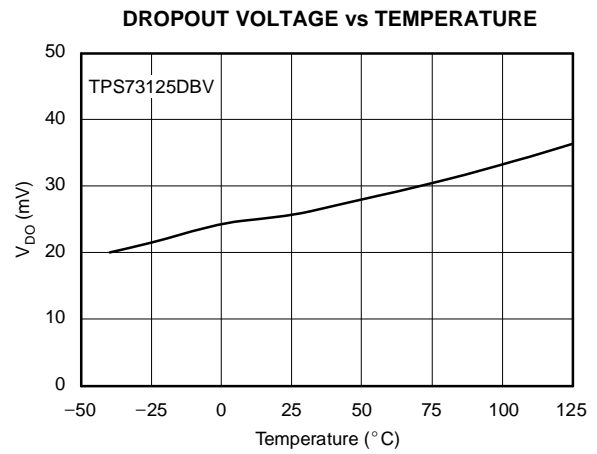

Figure 6.

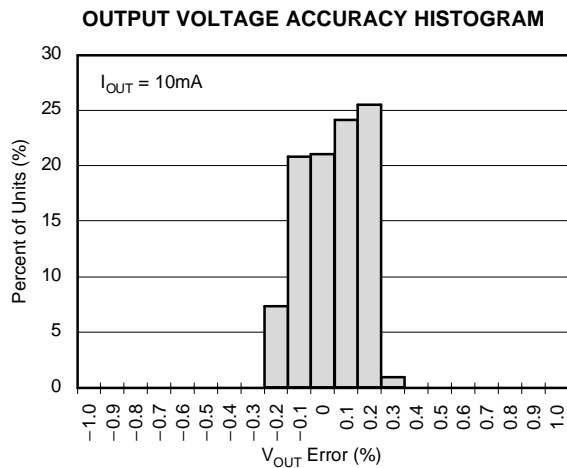

Figure 7.

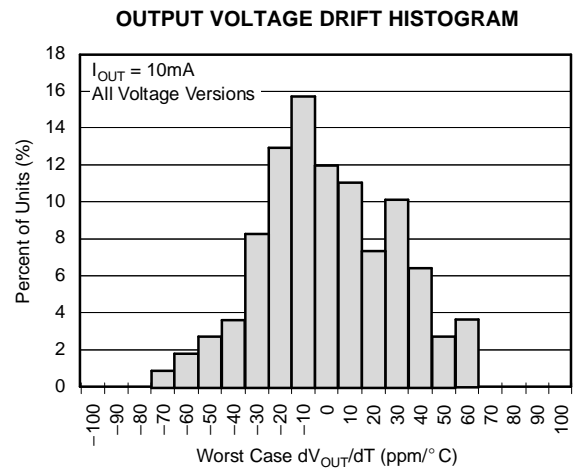

Figure 8.

## TYPICAL CHARACTERISTICS (continued)

For all voltage versions at  $T_J = 25^\circ\text{C}$ ,  $V_{IN} = V_{OUT(nom)} + 0.5\text{V}$ ,  $I_{OUT} = 10\text{mA}$ ,  $V_{EN} = 1.7\text{V}$ , and  $C_{OUT} = 0.1\mu\text{F}$ , unless otherwise noted.

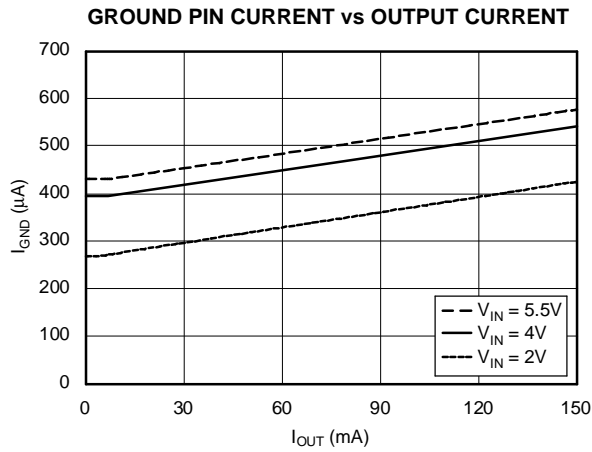

Figure 9.

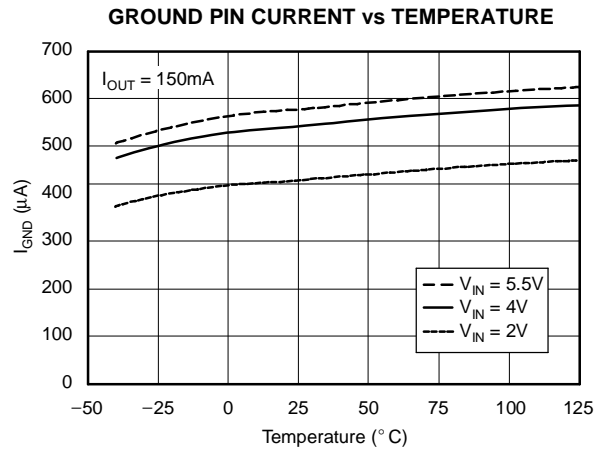

Figure 10.

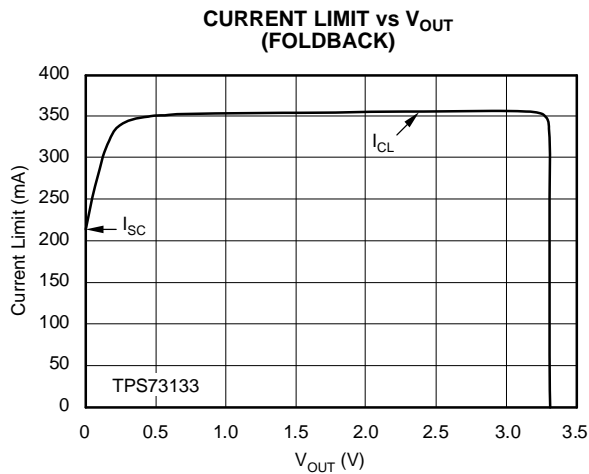

Figure 11.

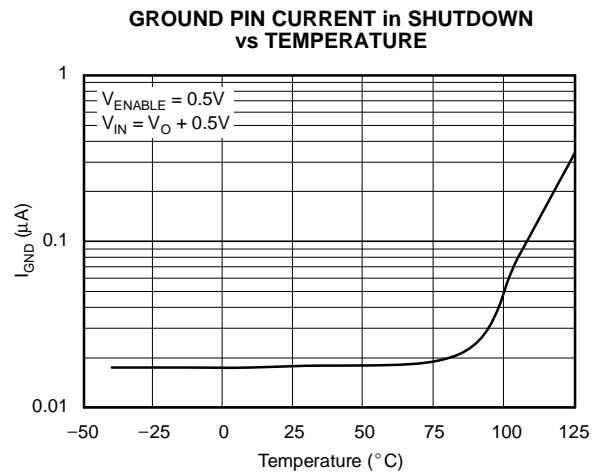

Figure 12.

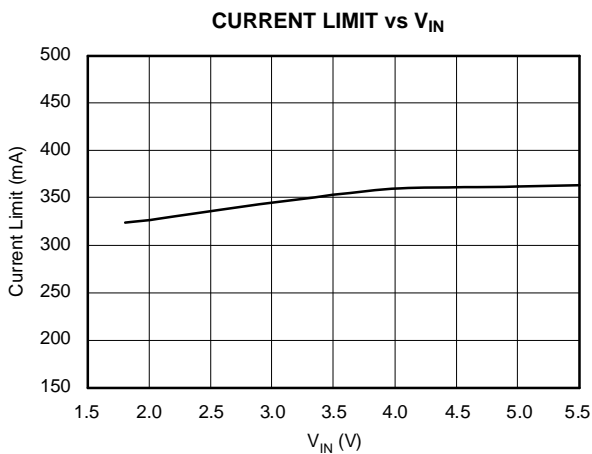

Figure 13.

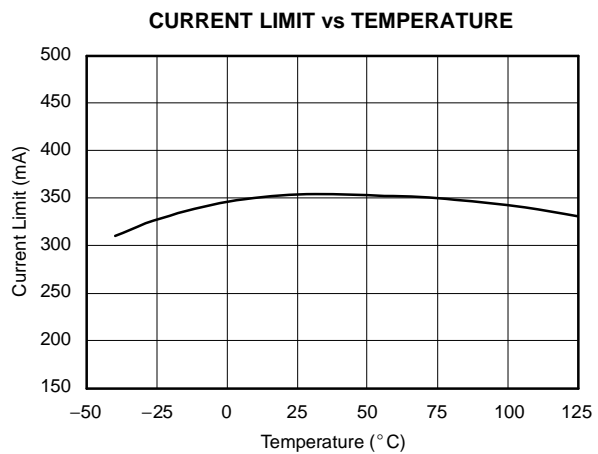

Figure 14.

**TYPICAL CHARACTERISTICS (continued)**

For all voltage versions at  $T_J = 25^\circ\text{C}$ ,  $V_{IN} = V_{OUT(nom)} + 0.5\text{V}$ ,  $I_{OUT} = 10\text{mA}$ ,  $V_{EN} = 1.7\text{V}$ , and  $C_{OUT} = 0.1\mu\text{F}$ , unless otherwise noted.

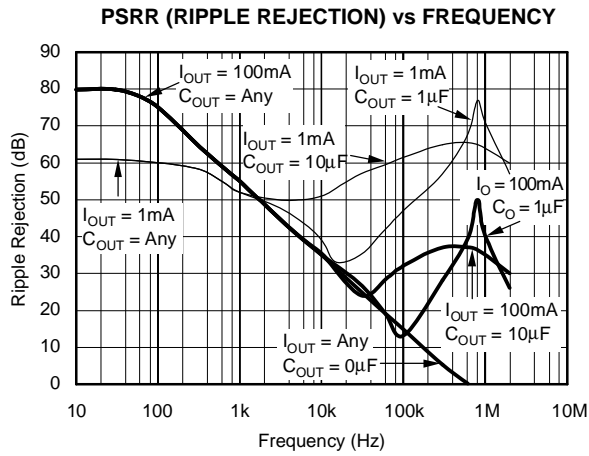

Figure 15.

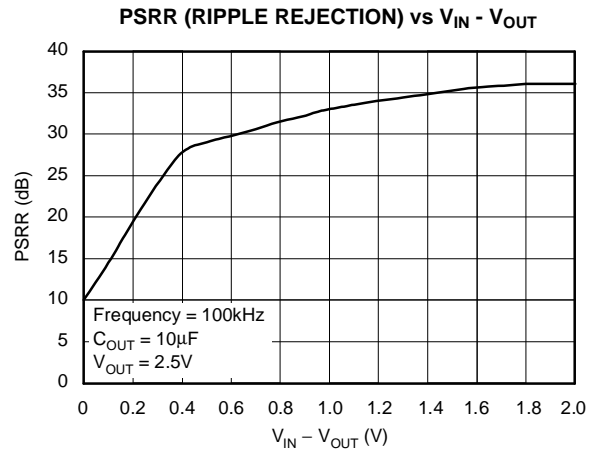

Figure 16.

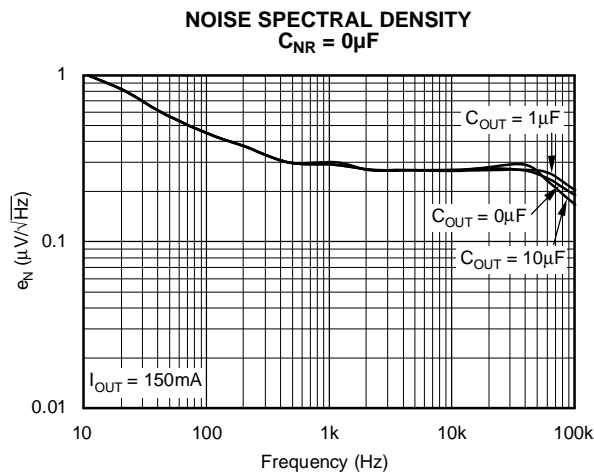

Figure 17.

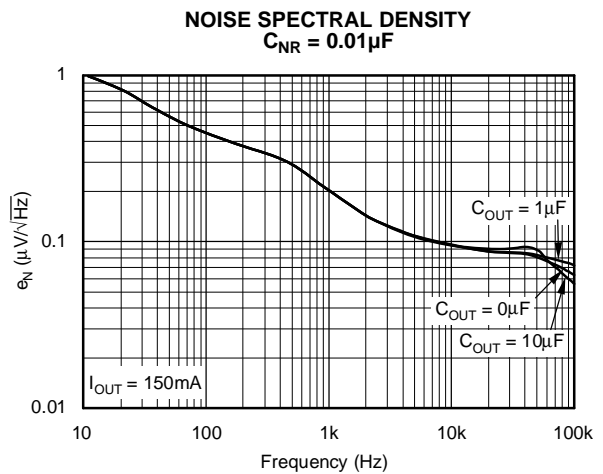

Figure 18.

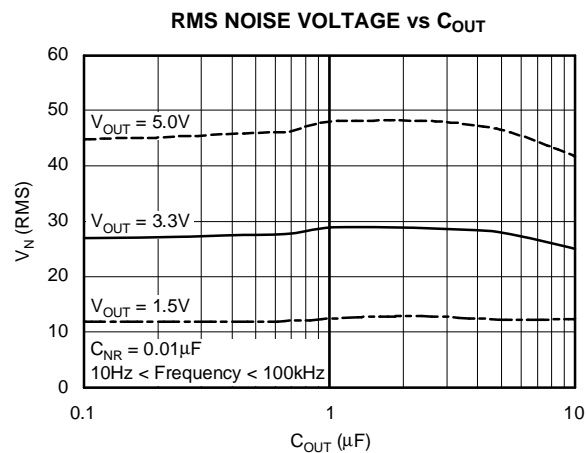

Figure 19.

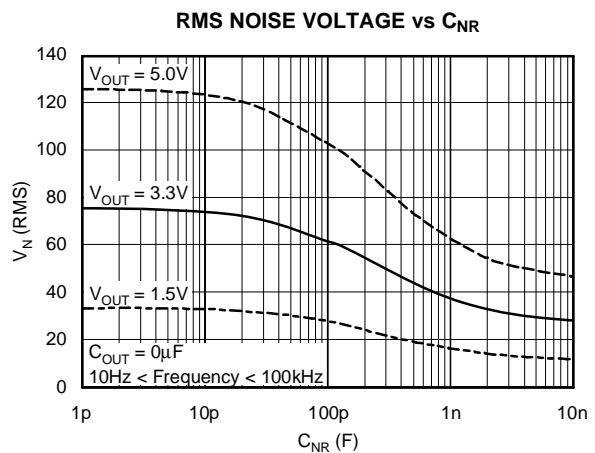
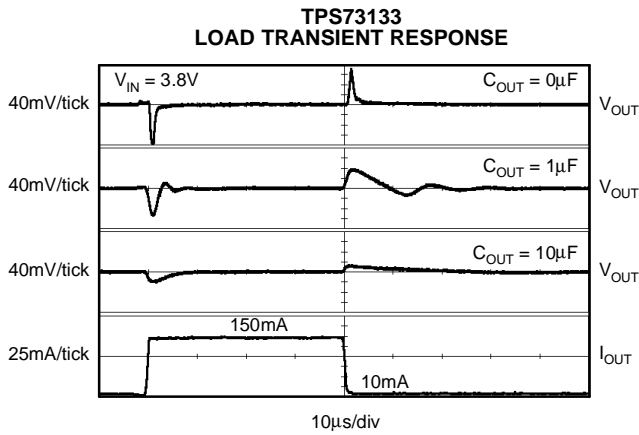

Figure 20.



**TYPICAL CHARACTERISTICS (continued)**

For all voltage versions at  $T_J = 25^\circ\text{C}$ ,  $V_{IN} = V_{OUT(nom)} + 0.5\text{V}$ ,  $I_{OUT} = 10\text{mA}$ ,  $V_{EN} = 1.7\text{V}$ , and  $C_{OUT} = 0.1\mu\text{F}$ , unless otherwise noted.



**Figure 21.**

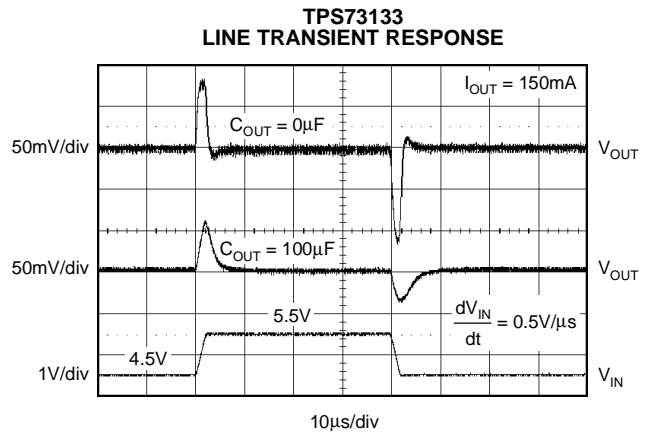

**Figure 22.**

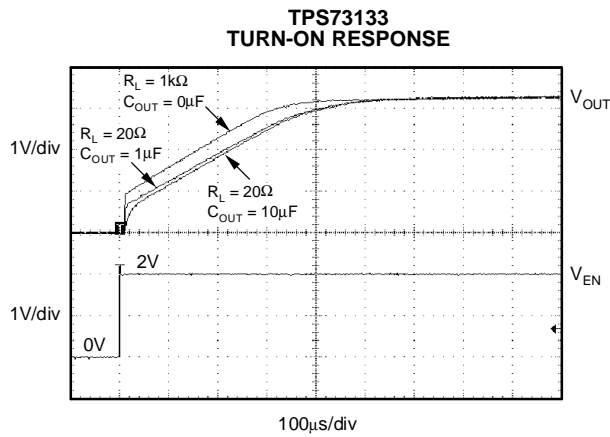

**Figure 23.**

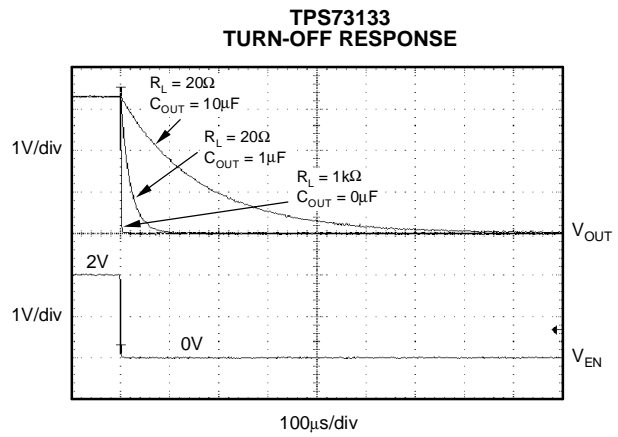

**Figure 24.**

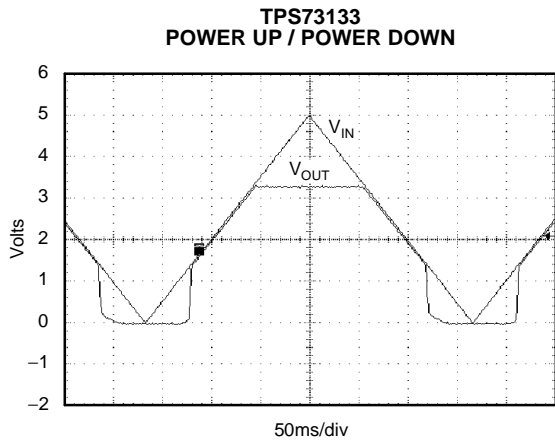

**Figure 25.**

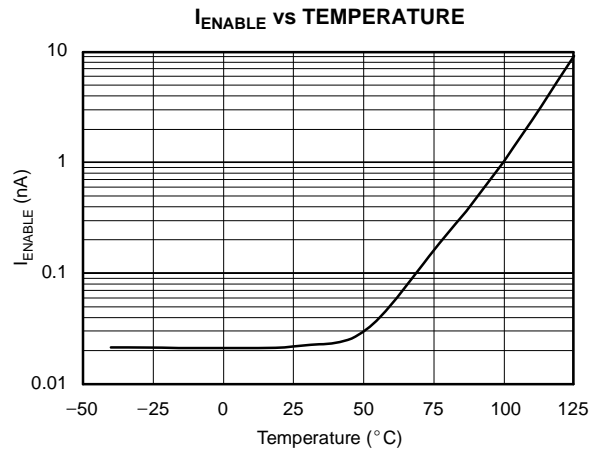

**Figure 26.**

**TYPICAL CHARACTERISTICS (continued)**

For all voltage versions at  $T_J = 25^\circ\text{C}$ ,  $V_{IN} = V_{OUT(nom)} + 0.5\text{V}$ ,  $I_{OUT} = 10\text{mA}$ ,  $V_{EN} = 1.7\text{V}$ , and  $C_{OUT} = 0.1\mu\text{F}$ , unless otherwise noted.

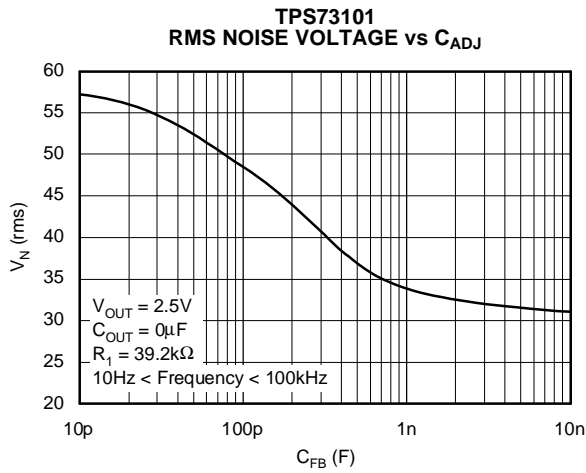

**Figure 27.**

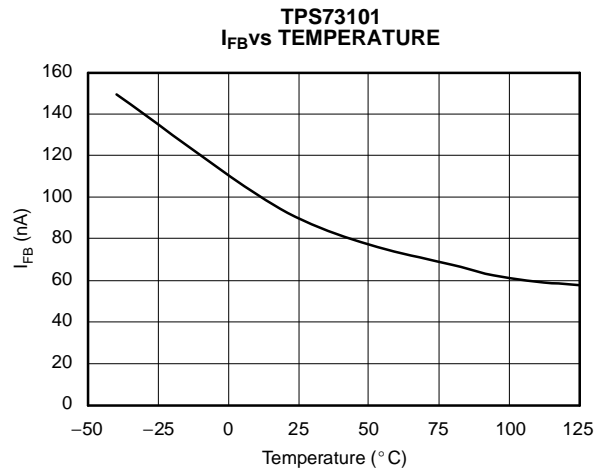

**Figure 28.**

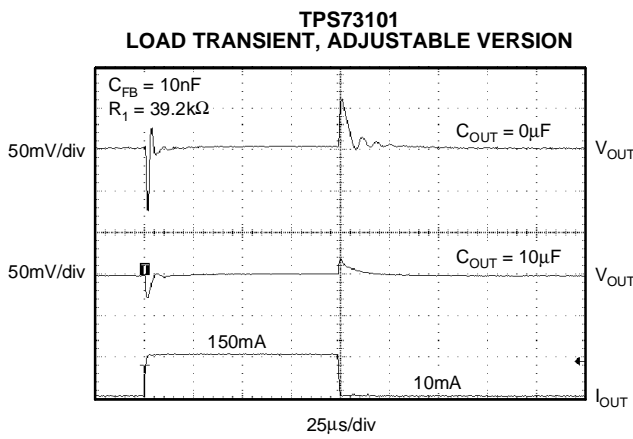

**Figure 29.**

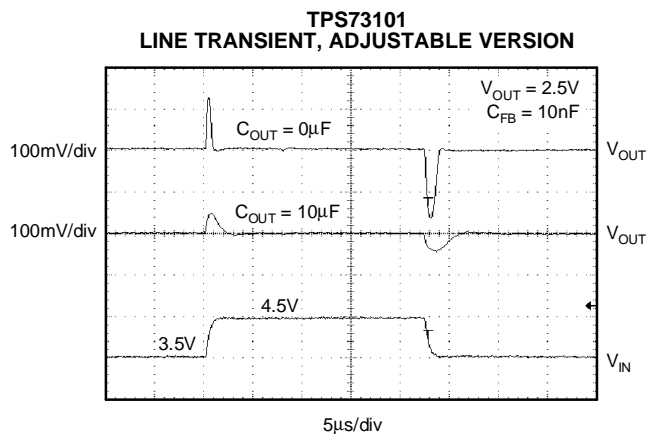
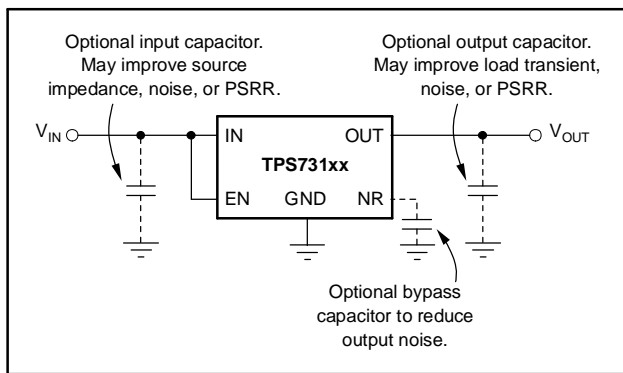

**Figure 30.**

## APPLICATION INFORMATION

The TPS731xx belongs to a family of new generation LDO regulators that use an NMOS pass transistor to achieve ultra-low-dropout performance, reverse current blockage, and freedom from output capacitor constraints. These features, combined with low noise and an enable input, make the TPS731xx ideal for portable applications. This regulator family offers a wide selection of fixed output voltage versions and an adjustable output version. All versions have thermal and over-current protection, including foldback current limit.

Figure 31 shows the basic circuit connections for the fixed voltage models. Figure 32 gives the connections for the adjustable output version (TPS73101).



**Figure 31. Typical Application Circuit for Fixed-Voltage Versions**

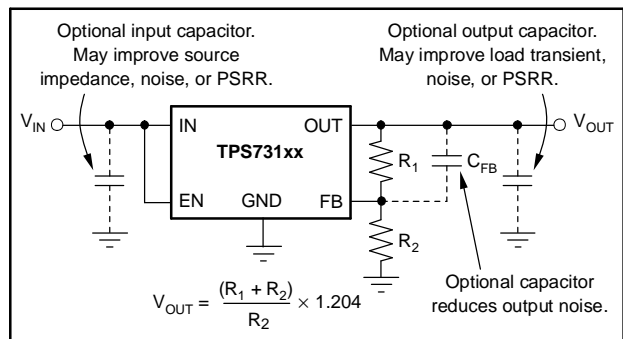

**Figure 32. Typical Application Circuit for Adjustable-Voltage Versions**

$R_1$  and  $R_2$  can be calculated for any output voltage using the formula shown in Figure 32. Sample resistor values for common output voltages are shown in Figure 2. For best accuracy, make the parallel combination of  $R_1$  and  $R_2$  approximately 19k $\Omega$ .

## INPUT AND OUTPUT CAPACITOR REQUIREMENTS

Although an input capacitor is not required for stability, it is good analog design practice to connect a 0.1 $\mu$ F to 1 $\mu$ F low ESR capacitor across the input supply near the regulator. This counteracts reactive input sources and improves transient response, noise rejection, and ripple rejection. A higher-value capacitor may be necessary if large, fast rise-time load transients are anticipated or the device is located several inches from the power source.

The TPS731xx does not require an output capacitor for stability and has maximum phase margin with no capacitor. It is designed to be stable for all available types and values of capacitors. In applications where  $V_{IN} - V_{OUT} < 0.5V$  and multiple low ESR capacitors are in parallel, ringing may occur when the product of  $C_{OUT}$  and total ESR drops below 50n $\Omega$ F. Total ESR includes all parasitic resistances, including capacitor ESR and board, socket, and solder joint resistance. In most applications, the sum of capacitor ESR and trace resistance will meet this requirement.

## OUTPUT NOISE

A precision band-gap reference is used to generate the internal reference voltage,  $V_{REF}$ . This reference is the dominant noise source within the TPS731xx and it generates approximately 32 $\mu$ V<sub>RMS</sub> (10Hz to 100kHz) at the reference output (NR). The regulator control loop gains up the reference noise with the same gain as the reference voltage, so that the noise voltage of the regulator is approximately given by:

$$V_N = 32\mu V_{RMS} \times \frac{(R_1 + R_2)}{R_2} = 32\mu V_{RMS} \times \frac{V_{OUT}}{V_{REF}} \quad (1)$$

Since the value of  $V_{REF}$  is 1.2V, this relationship reduces to:

$$V_N(\mu V_{RMS}) = 27 \left( \frac{\mu V_{RMS}}{V} \right) \times V_{OUT}(V) \quad (2)$$

for the case of no  $C_{NR}$ .

An internal 27k $\Omega$  resistor in series with the noise reduction pin (NR) forms a low-pass filter for the voltage reference when an external noise reduction capacitor,  $C_{NR}$ , is connected from NR to ground. For  $C_{NR} = 10nF$ , the total noise in the 10Hz to 100kHz bandwidth is reduced by a factor of ~3.2, giving the approximate relationship:

$$V_N(\mu V_{RMS}) = 8.5 \left( \frac{\mu V_{RMS}}{V} \right) \times V_{OUT}(V) \quad (3)$$

for  $C_{NR} = 10nF$ .

This noise reduction effect is shown as *RMS Noise Voltage vs C<sub>NR</sub>* in the Typical Characteristics section.

The TPS73101 adjustable version does not have the noise-reduction pin available. However, connecting a feedback capacitor, C<sub>FB</sub>, from the output to the FB pin will reduce output noise and improve load transient performance.

The TPS731xx uses an internal charge pump to develop an internal supply voltage sufficient to drive the gate of the NMOS pass element above V<sub>OUT</sub>. The charge pump generates ~250μV of switching noise at ~4MHz; however, charge-pump noise contribution is negligible at the output of the regulator for most values of I<sub>OUT</sub> and C<sub>OUT</sub>.

### BOARD LAYOUT RECOMMENDATION TO IMPROVE PSRR AND NOISE PERFORMANCE

To improve ac performance such as PSRR, output noise, and transient response, it is recommended that the PCB be designed with separate ground planes for V<sub>IN</sub> and V<sub>OUT</sub>, with each ground plane connected only at the GND pin of the device. In addition, the ground connection for the bypass capacitor should connect directly to the GND pin of the device.

### INTERNAL CURRENT LIMIT

The TPS731xx internal current limit helps protect the regulator during fault conditions. Foldback current helps to protect the regulator from damage during output short-circuit conditions by reducing current limit when V<sub>OUT</sub> drops below 0.5V. See Figure 11 in the Typical Characteristics section for a graph of I<sub>OUT</sub> vs V<sub>OUT</sub>.

### SHUTDOWN

The Enable pin is active high and is compatible with standard TTL-CMOS levels. V<sub>EN</sub> below 0.5V (max) turns the regulator off and drops the ground pin current to approximately 10nA. When shutdown capability is not required, the Enable pin can be connected to V<sub>IN</sub>. When a pull-up resistor is used, and operation down to 1.8V is required, use pull-up resistor values below 50 kΩ.

### DROPOUT VOLTAGE

The TPS731xx uses an NMOS pass transistor to achieve extremely low dropout. When (V<sub>IN</sub> - V<sub>OUT</sub>) is less than the dropout voltage (V<sub>DO</sub>), the NMOS pass device is in its linear region of operation and the input-to-output resistance is the R<sub>DS-ON</sub> of the NMOS pass element.

For large step changes in load current, the TPS731xx requires a larger voltage drop across it to avoid degraded transient response. The boundary of this transient dropout region is approximately twice the dc dropout. Values of V<sub>IN</sub> - V<sub>OUT</sub> above this line insure normal transient response.

Operating in the transient dropout region can cause an increase in recovery time. The time required to recover from a load transient is a function of the magnitude of the change in load current rate, the rate of change in load current, and the available headroom (V<sub>IN</sub> to V<sub>OUT</sub> voltage drop). Under worst-case conditions [full-scale instantaneous load change with (V<sub>IN</sub> - V<sub>OUT</sub>) close to dc dropout levels], the TPS731xx can take a couple of hundred microseconds to return to the specified regulation accuracy.

### TRANSIENT RESPONSE

The low open-loop output impedance provided by the NMOS pass element in a voltage follower configuration allows operation without an output capacitor for many applications. As with any regulator, the addition of a capacitor (nominal value 1μF) from the output pin to ground will reduce undershoot magnitude but increase duration. In the adjustable version, the addition of a capacitor, C<sub>FB</sub>, from the output to the adjust pin will also improve the transient response.

The TPS731xx does not have active pull-down when the output is over-voltage. This allows applications that connect higher voltage sources, such as alternate power supplies, to the output. This also results in an output overshoot of several percent if the load current quickly drops to zero when a capacitor is connected to the output. The duration of overshoot can be reduced by adding a load resistor. The overshoot decays at a rate determined by output capacitor C<sub>OUT</sub> and the internal/external load resistance. The rate of decay is given by:

(Fixed voltage version)

$$dV/dt = \frac{V_{OUT}}{C_{OUT} \times 80k\Omega} \quad (4)$$

(Adjustable voltage version)

$$dV/dt = \frac{V_{OUT}}{C_{OUT} \times 80k\Omega \parallel (R_1 + R_2)} \quad (5)$$

## REVERSE CURRENT

The NMOS pass element of the TPS731xx provides inherent protection against current flow from the output of the regulator to the input when the gate of the pass device is pulled low. To ensure that all charge is removed from the gate of the pass element, the enable pin must be driven low before the input voltage is removed. If this is not done, the pass element may be left on due to stored charge on the gate.

After the enable pin is driven low, no bias voltage is needed on any pin for reverse current blocking. Note that reverse current is specified as the current flowing out of the IN pin due to voltage applied on the OUT pin. There will be additional current flowing into the OUT pin due to the 80kΩ internal resistor divider to ground (see Figure 1 and Figure 2).

For the TPS73101, reverse current may flow when  $V_{FB}$  is more than 1.0V above  $V_{IN}$ .

## THERMAL PROTECTION

Thermal protection disables the output when the junction temperature rises to approximately 160°C, allowing the device to cool. When the junction temperature cools to approximately 140°C, the output circuitry is again enabled. Depending on power dissipation, thermal resistance, and ambient temperature, the thermal protection circuit may cycle on and off. This limits the dissipation of the regulator, protecting it from damage due to overheating.

Any tendency to activate the thermal protection circuit indicates excessive power dissipation or an inadequate heatsink. For reliable operation, junction temperature should be limited to 125°C maximum. To estimate the margin of safety in a complete design (including heatsink), increase the ambient temperature until the thermal protection is triggered; use worst-case loads and signal conditions. For good

reliability, thermal protection should trigger at least 35°C above the maximum expected ambient condition of your application. This produces a worst-case junction temperature of 125°C at the highest expected ambient temperature and worst-case load.

The internal protection circuitry of the TPS731xx has been designed to protect against overload conditions. It was not intended to replace proper heatsinking. Continuously running the TPS731xx into thermal shutdown will degrade device reliability.

## POWER DISSIPATION

The ability to remove heat from the die is different for each package type, presenting different considerations in the PCB layout. The PCB area around the device that is free of other components moves the heat from the device to the ambient air. Performance data for JEDEC low- and high-K boards are shown in the Power Dissipation Ratings table. Using heavier copper will increase the effectiveness in removing heat from the device. The addition of plated through-holes to heat-dissipating layers will also improve the heat-sink effectiveness.

Power dissipation depends on input voltage and load conditions. Power dissipation is equal to the product of the output current times the voltage drop across the output pass element ( $V_{IN}$  to  $V_{OUT}$ ):

$$P_D = (V_{IN} - V_{OUT}) \times I_{OUT} \quad (6)$$

Power dissipation can be minimized by using the lowest possible input voltage necessary to assure the required output voltage.

## Package Mounting

Solder pad footprint recommendations for the TPS731xx are presented in Application Bulletin *Solder Pad Recommendations for Surface-Mount Devices* (AB-132), available from the Texas Instruments web site at [www.ti.com](http://www.ti.com).

**PACKAGING INFORMATION**

ORDERABLE DEVICE	STATUS(1)	PACKAGE TYPE	PACKAGE DRAWING	PINS	PACKAGE QTY
TPS73101DBVR	ACTIVE	SOP	DBV	5	3000
TPS73101DBVT	ACTIVE	SOP	DBV	5	250
TPS73115DBVR	ACTIVE	SOP	DBV	5	3000
TPS73115DBVT	ACTIVE	SOP	DBV	5	250
TPS73118DBVR	ACTIVE	SOP	DBV	5	3000
TPS73118DBVT	ACTIVE	SOP	DBV	5	250
TPS73125DBVR	ACTIVE	SOP	DBV	5	3000
TPS73125DBVT	ACTIVE	SOP	DBV	5	250
TPS73130DBVR	ACTIVE	SOP	DBV	5	3000
TPS73130DBVT	ACTIVE	SOP	DBV	5	250
TPS73132DBVR	ACTIVE	SOP	DBV	5	3000
TPS73132DBVT	ACTIVE	SOP	DBV	5	250
TPS73133DBVR	ACTIVE	SOP	DBV	5	3000
TPS73133DBVT	ACTIVE	SOP	DBV	5	250
TPS73150DBVR	ACTIVE	SOP	DBV	5	3000
TPS73150DBVT	ACTIVE	SOP	DBV	5	250

(1) The marketing status values are defined as follows:

**ACTIVE:** Product device recommended for new designs.

**LIFEBUY:** TI has announced that the device will be discontinued, and a lifetime-buy period is in effect.

**NRND:** Not recommended for new designs. Device is in production to support existing customers, but TI does not recommend using this part in a new design.

**PREVIEW:** Device has been announced but is not in production. Samples may or may not be available.

**OBSOLETE:** TI has discontinued the production of the device.

DBV (R-PDSO-G5)

PLASTIC SMALL-OUTLINE PACKAGE

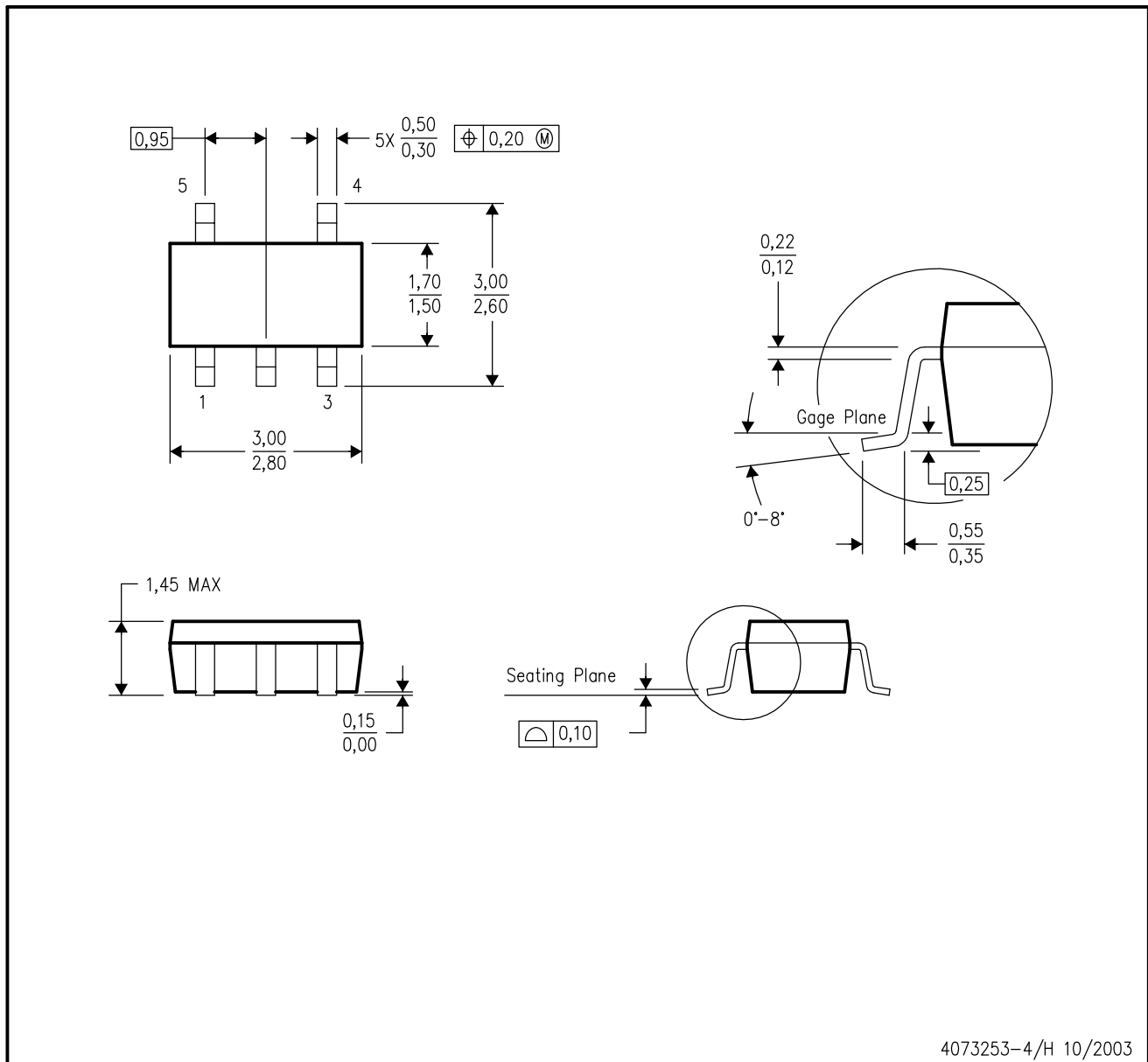

- NOTES:
- A. All linear dimensions are in millimeters.
  - B. This drawing is subject to change without notice.
  - C. Body dimensions do not include mold flash or protrusion.
  - D. Falls within JEDEC MO-178 Variation AA.

## IMPORTANT NOTICE

Texas Instruments Incorporated and its subsidiaries (TI) reserve the right to make corrections, modifications, enhancements, improvements, and other changes to its products and services at any time and to discontinue any product or service without notice. Customers should obtain the latest relevant information before placing orders and should verify that such information is current and complete. All products are sold subject to TI's terms and conditions of sale supplied at the time of order acknowledgment.

TI warrants performance of its hardware products to the specifications applicable at the time of sale in accordance with TI's standard warranty. Testing and other quality control techniques are used to the extent TI deems necessary to support this warranty. Except where mandated by government requirements, testing of all parameters of each product is not necessarily performed.

TI assumes no liability for applications assistance or customer product design. Customers are responsible for their products and applications using TI components. To minimize the risks associated with customer products and applications, customers should provide adequate design and operating safeguards.

TI does not warrant or represent that any license, either express or implied, is granted under any TI patent right, copyright, mask work right, or other TI intellectual property right relating to any combination, machine, or process in which TI products or services are used. Information published by TI regarding third-party products or services does not constitute a license from TI to use such products or services or a warranty or endorsement thereof. Use of such information may require a license from a third party under the patents or other intellectual property of the third party, or a license from TI under the patents or other intellectual property of TI.

Reproduction of information in TI data books or data sheets is permissible only if reproduction is without alteration and is accompanied by all associated warranties, conditions, limitations, and notices. Reproduction of this information with alteration is an unfair and deceptive business practice. TI is not responsible or liable for such altered documentation.

Resale of TI products or services with statements different from or beyond the parameters stated by TI for that product or service voids all express and any implied warranties for the associated TI product or service and is an unfair and deceptive business practice. TI is not responsible or liable for any such statements.

Following are URLs where you can obtain information on other Texas Instruments products and application solutions:

<b>Products</b>		<b>Applications</b>	
Amplifiers	<a href="http://amplifier.ti.com">amplifier.ti.com</a>	Audio	<a href="http://www.ti.com/audio">www.ti.com/audio</a>
Data Converters	<a href="http://dataconverter.ti.com">dataconverter.ti.com</a>	Automotive	<a href="http://www.ti.com/automotive">www.ti.com/automotive</a>
DSP	<a href="http://dsp.ti.com">dsp.ti.com</a>	Broadband	<a href="http://www.ti.com/broadband">www.ti.com/broadband</a>
Interface	<a href="http://interface.ti.com">interface.ti.com</a>	Digital Control	<a href="http://www.ti.com/digitalcontrol">www.ti.com/digitalcontrol</a>
Logic	<a href="http://logic.ti.com">logic.ti.com</a>	Military	<a href="http://www.ti.com/military">www.ti.com/military</a>
Power Mgmt	<a href="http://power.ti.com">power.ti.com</a>	Optical Networking	<a href="http://www.ti.com/opticalnetwork">www.ti.com/opticalnetwork</a>
Microcontrollers	<a href="http://microcontroller.ti.com">microcontroller.ti.com</a>	Security	<a href="http://www.ti.com/security">www.ti.com/security</a>
		Telephony	<a href="http://www.ti.com/telephony">www.ti.com/telephony</a>
		Video & Imaging	<a href="http://www.ti.com/video">www.ti.com/video</a>
		Wireless	<a href="http://www.ti.com/wireless">www.ti.com/wireless</a>

Mailing Address: Texas Instruments  
Post Office Box 655303 Dallas, Texas 75265