

MBR40250, MBR40250T, MBRF40250T

250 V, 40 A SWITCHMODE™ Schottky Power Rectifier

Features

- 250 V Blocking Voltage
- Low Forward Voltage Drop, $V_F = 0.86$ V
- Soft Recovery Characteristic, $T_{RR} < 35$ ns
- Low Reverse Current, $I_R = 30$ μ A
- Stable Switching Performance Over Temperature
- Pb-Free Packages are Available

Benefits

- Reduces or Eliminates Reverse Recovery Oscillations
- Minimizes Need for EMI Filtering
- Reduces Switching Losses
- Improved Efficiency

Applications

- Power Supply
- Power Management
- Automotive
- Instrumentation

Mechanical Characteristics

- Case: Epoxy, Molded
- Weight: 1.9 grams (approximately)
- Finish: All External Surfaces Corrosion Resistant and Terminal Leads are Readily Solderable
- Lead Temperature for Soldering Purposes:
260°C Max. for 10 Seconds
- Epoxy Meets UL 94 V-0 at 0.125 in



ON Semiconductor®

<http://onsemi.com>

SCHOTTKY RECTIFIER 40 AMPERES, 250 VOLTS

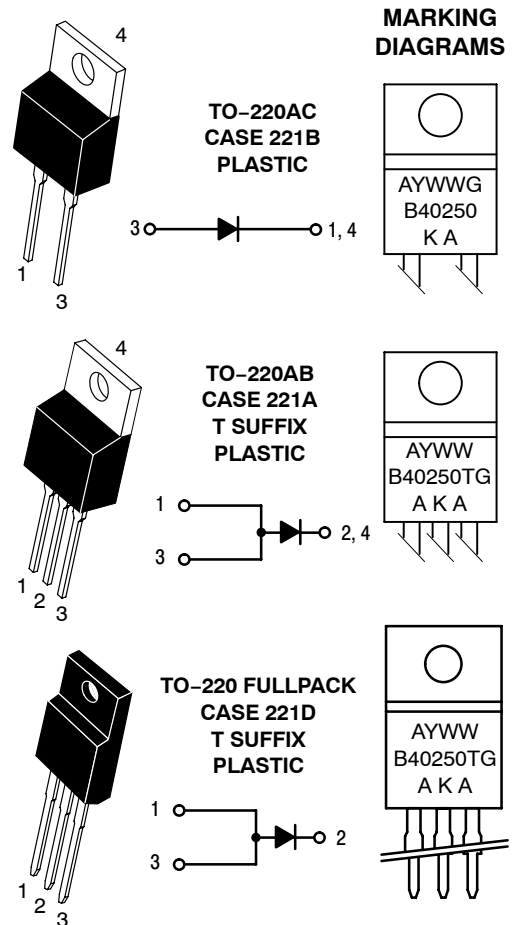

B40250 = Device Code
 T = 3 pins
 A = Assembly Location
 Y = Year
 WW = Work Week
 G = Pb-Free Package
 KA, AKA = Polarity Designator

ORDERING INFORMATION

See detailed ordering and shipping information in the package dimensions section on page 4 of this data sheet.

MBR40250, MBR40250T, MBRF40250T

MAXIMUM RATINGS

Rating	Symbol	Value	Unit
Peak Repetitive Reverse Voltage Working Peak Reverse Voltage DC Blocking Voltage	V_{RRM} V_{RWM} V_R	250	V
Average Rectified Forward Current (Rated V_R , $T_C = 82^\circ\text{C}$ MBR40250, MBR40250T (Rated V_R , $T_C = 46^\circ\text{C}$ MBRF40250T)	$I_{F(AV)}$	40	A
Peak Repetitive Forward Current (Rated V_R , Square Wave, 20 kHz) $T_C = 82^\circ\text{C}$ MBR40250, MBR40250T (Rated V_R , Square Wave, 20 kHz) $T_C = 46^\circ\text{C}$ MBRF40250T	I_{FRM}	80	A
Nonrepetitive Peak Surge Current (Surge applied at rated load conditions halfwave, single phase, 20 kHz)	I_{FSM}	150	A
Storage Temperature	T_{stg}	-65 to +175	$^\circ\text{C}$
Operating Junction Temperature	T_J	-65 to +150	$^\circ\text{C}$
Voltage Rate of Change (Rated V_R)	dv/dt	10,000	V/ μs

Maximum ratings are those values beyond which device damage can occur. Maximum ratings applied to the device are individual stress limit values (not normal operating conditions) and are not valid simultaneously. If these limits are exceeded, device functional operation is not implied, damage may occur and reliability may be affected.

THERMAL CHARACTERISTICS

Rating	Symbol	Value	Unit
Maximum Thermal Resistance Junction-to-Case MBR40250(T) MBRF40250 Junction-to-Ambient MBR40250(T) MBRF40250	$R_{\theta JC}$	2.0 3.0	$^\circ\text{C}/\text{W}$
	$R_{\theta JA}$	60 50	

ELECTRICAL CHARACTERISTICS

Rating	Symbol	Value	Unit
Maximum Instantaneous Forward Voltage (Note 1) $I_F = 20\text{ A}$, $T_C = 25^\circ\text{C}$ $I_F = 20\text{ A}$, $T_C = 125^\circ\text{C}$ $I_F = 40\text{ A}$, $T_C = 25^\circ\text{C}$ $I_F = 40\text{ A}$, $T_C = 125^\circ\text{C}$	V_F	0.86 0.71 0.97 0.86	V
Maximum Instantaneous Reverse Current (Note 1) Rated DC Voltage, $T_C = 25^\circ\text{C}$ Rated DC Voltage, $T_C = 125^\circ\text{C}$	I_R	0.03 30	mA
Maximum Reverse Recovery Time $I_F = 1.0\text{ A}$, $di/dt = 50\text{ A}/\mu\text{s}$, $T_C = 25^\circ\text{C}$	t_{rr}	35	ns

DYNAMIC CHARACTERISTICS

Capacitance $V_R = -5.0\text{ V}$, $T_C = 25^\circ\text{C}$, Frequency = 1.0 MHz	C_T	500	pF
---	-------	-----	----

1. Pulse Test: Pulse Width = 300 μs , Duty Cycle $\leq 2.0\%$.

MBR40250, MBR40250T, MBRF40250T

TYPICAL CHARACTERISTICS

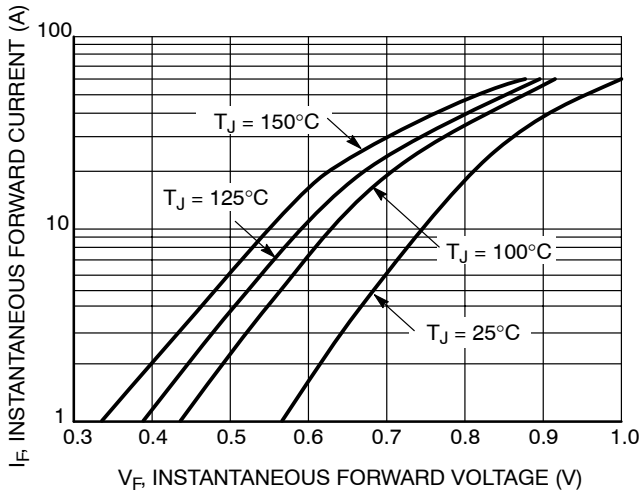

Figure 1. Typical Forward Voltage

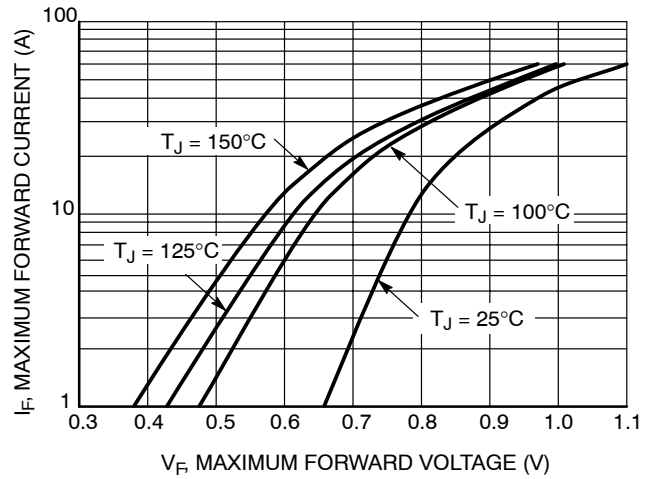

Figure 2. Maximum Forward Voltage

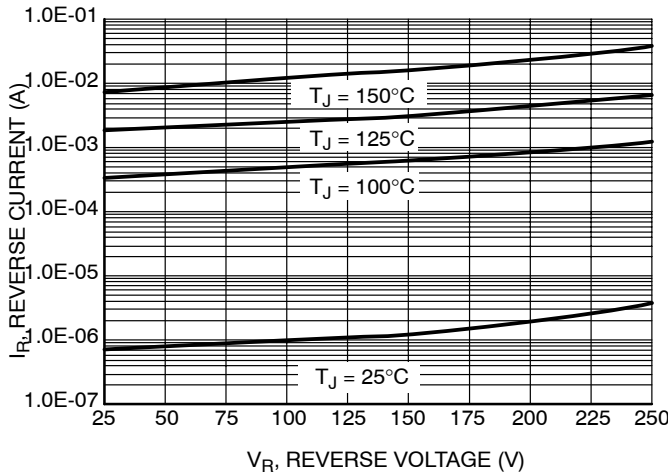

Figure 3. Typical Reverse Current

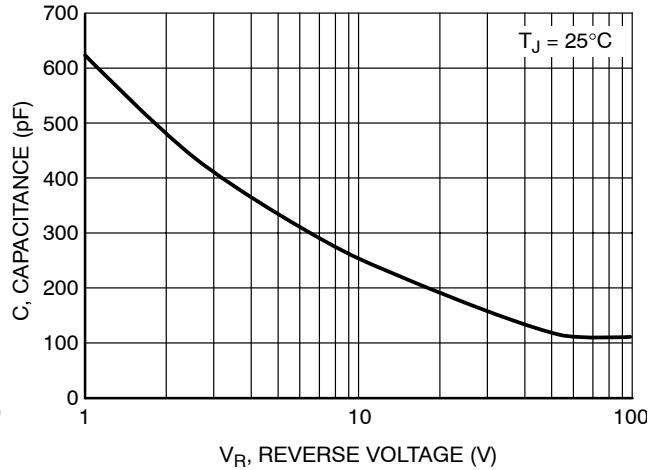

Figure 4. Typical Capacitance

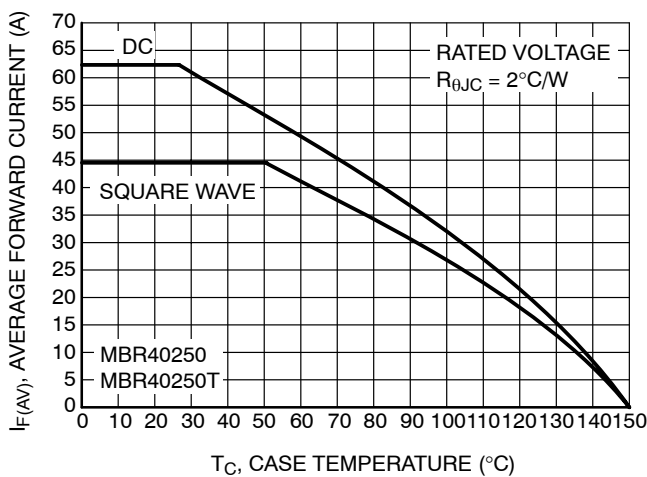

Figure 5. Current Derating (Case) for MBR40250 and MBR40250T

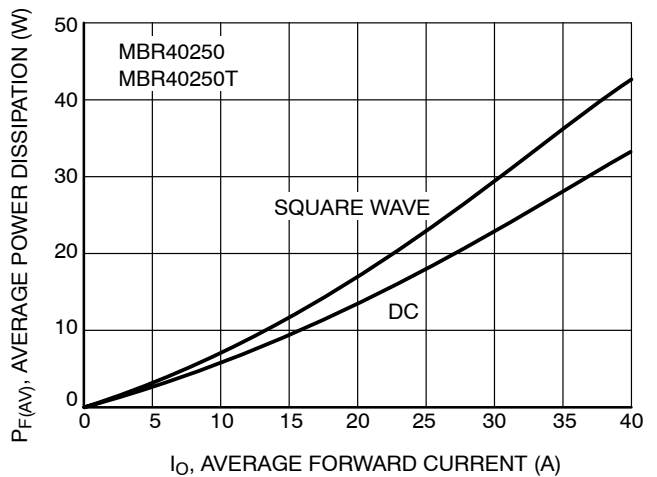

Figure 6. Forward Power Dissipation for MBR40250 and MBR40250T

MBR40250, MBR40250T, MBRF40250T

TYPICAL CHARACTERISTICS

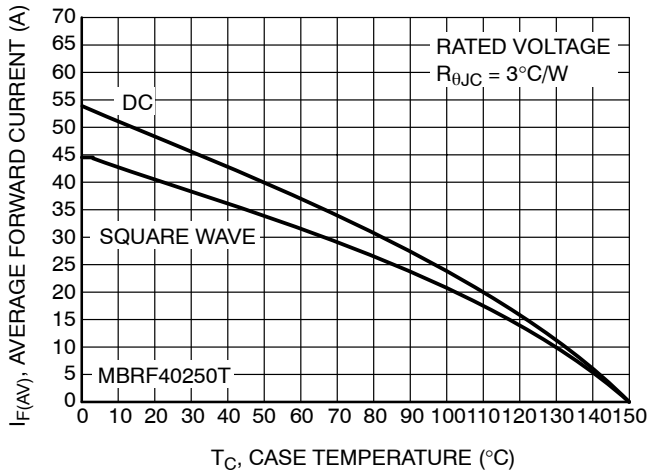

Figure 7. Current Derating (Case) for MBRF40250T

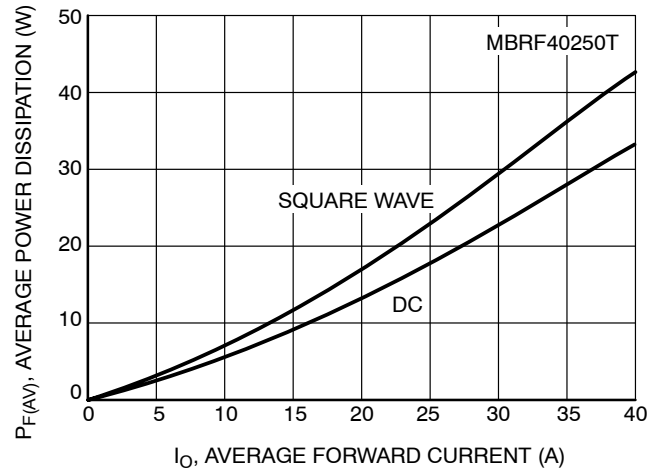

Figure 8. Forward Power Dissipation for MBRF40250T

ORDERING INFORMATION

Device	Package	Shipping†
MBR40250	TO-220AC	50 Units / Rail
MBR40250G	TO-220AC (Pb-Free)	
MBR40250T	TO-220AB	50 Units / Rail
MBR40250TG	TO-220AB (Pb-Free)	
MBRF40250T	TO-220 FULLPACK	50 Units / Rail
MBRF40250TG	TO-220 FULLPACK (Pb-Free)	

MBR40250, MBR40250T, MBRF40250T

PACKAGE DIMENSIONS

TO-220AB CASE 221A-09 ISSUE AA

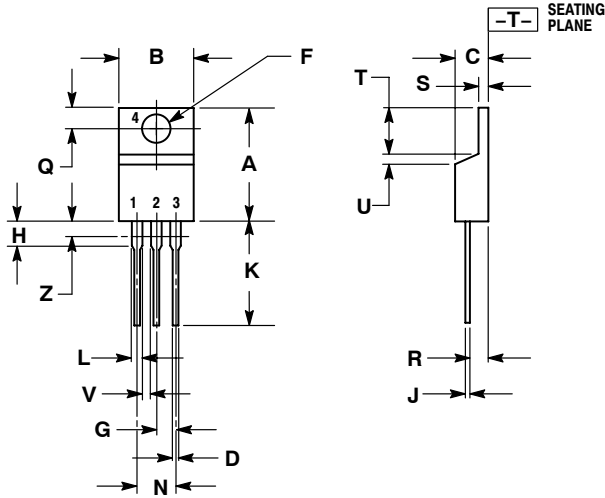

- NOTES:
1. DIMENSIONING AND TOLERANCING PER ANSI Y14.5M, 1982.
 2. CONTROLLING DIMENSION: INCH.
 3. DIMENSION Z DEFINES A ZONE WHERE ALL BODY AND LEAD IRREGULARITIES ARE ALLOWED.

DIM	INCHES		MILLIMETERS	
	MIN	MAX	MIN	MAX
A	0.570	0.620	14.48	15.75
B	0.380	0.405	9.66	10.28
C	0.160	0.190	4.07	4.82
D	0.025	0.035	0.64	0.88
F	0.142	0.147	3.61	3.73
G	0.095	0.105	2.42	2.66
H	0.110	0.155	2.80	3.93
J	0.018	0.025	0.46	0.64
K	0.500	0.562	12.70	14.27
L	0.045	0.060	1.15	1.52
N	0.190	0.210	4.83	5.33
Q	0.100	0.120	2.54	3.04
R	0.080	0.110	2.04	2.79
S	0.045	0.055	1.15	1.39
T	0.235	0.255	5.97	6.47
U	0.000	0.050	0.00	1.27
V	0.045	---	1.15	---
Z	---	0.080	---	2.04

TO-220AC CASE 221B-04 ISSUE D

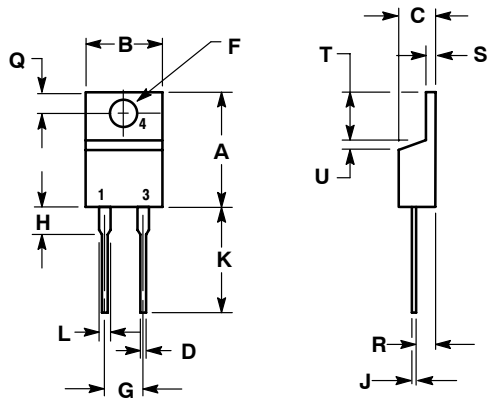

- NOTES:
1. DIMENSIONING AND TOLERANCING PER ANSI Y14.5M, 1982.
 2. CONTROLLING DIMENSION: INCH.

DIM	INCHES		MILLIMETERS	
	MIN	MAX	MIN	MAX
A	0.595	0.620	15.11	15.75
B	0.380	0.405	9.65	10.29
C	0.160	0.190	4.06	4.82
D	0.025	0.035	0.64	0.89
F	0.142	0.147	3.61	3.73
G	0.190	0.210	4.83	5.33
H	0.110	0.130	2.79	3.30
J	0.018	0.025	0.46	0.64
K	0.500	0.562	12.70	14.27
L	0.045	0.060	1.14	1.52
Q	0.100	0.120	2.54	3.04
R	0.080	0.110	2.04	2.79
S	0.045	0.055	1.14	1.39
T	0.235	0.255	5.97	6.48
U	0.000	0.050	0.000	1.27

MBR40250, MBR40250T, MBRF40250T

PACKAGE DIMENSIONS

TO-220 FULLPACK CASE 221D-03 ISSUE G

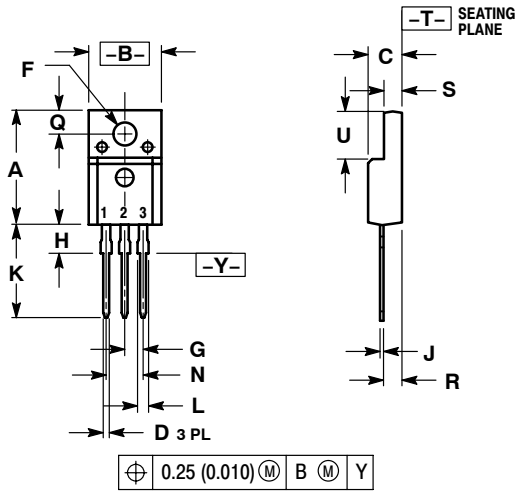

NOTES:

1. DIMENSIONING AND TOLERANCING PER ANSI Y14.5M, 1982.
2. CONTROLLING DIMENSION: INCH
3. 221D-01 THRU 221D-02 OBSOLETE, NEW STANDARD 221D-03.

DIM	INCHES		MILLIMETERS	
	MIN	MAX	MIN	MAX
A	0.625	0.635	15.88	16.12
B	0.408	0.418	10.37	10.63
C	0.180	0.190	4.57	4.83
D	0.026	0.031	0.65	0.78
F	0.116	0.119	2.95	3.02
G	0.100 BSC		2.54 BSC	
H	0.125	0.135	3.18	3.43
J	0.018	0.025	0.45	0.63
K	0.530	0.540	13.47	13.73
L	0.048	0.053	1.23	1.36
N	0.200 BSC		5.08 BSC	
Q	0.124	0.128	3.15	3.25
R	0.099	0.103	2.51	2.62
S	0.101	0.113	2.57	2.87
U	0.238	0.258	6.06	6.56

SWITCHMODE is a trademark of Semiconductor Components Industries, LLC (SCILLC).

ON Semiconductor and are registered trademarks of Semiconductor Components Industries, LLC (SCILLC). SCILLC reserves the right to make changes without further notice to any products herein. SCILLC makes no warranty, representation or guarantee regarding the suitability of its products for any particular purpose, nor does SCILLC assume any liability arising out of the application or use of any product or circuit, and specifically disclaims any and all liability, including without limitation special, consequential or incidental damages. "Typical" parameters which may be provided in SCILLC data sheets and/or specifications can and do vary in different applications and actual performance may vary over time. All operating parameters, including "Typicals" must be validated for each customer application by customer's technical experts. SCILLC does not convey any license under its patent rights nor the rights of others. SCILLC products are not designed, intended, or authorized for use as components in systems intended for surgical implant into the body, or other applications intended to support or sustain life, or for any other application in which the failure of the SCILLC product could create a situation where personal injury or death may occur. Should Buyer purchase or use SCILLC products for any such unintended or unauthorized application, Buyer shall indemnify and hold SCILLC and its officers, employees, subsidiaries, affiliates, and distributors harmless against all claims, costs, damages, and expenses, and reasonable attorney fees arising out of, directly or indirectly, any claim of personal injury or death associated with such unintended or unauthorized use, even if such claim alleges that SCILLC was negligent regarding the design or manufacture of the part. SCILLC is an Equal Opportunity/Affirmative Action Employer. This literature is subject to all applicable copyright laws and is not for resale in any manner.

PUBLICATION ORDERING INFORMATION

LITERATURE FULFILLMENT:
Literature Distribution Center for ON Semiconductor
P.O. Box 61312, Phoenix, Arizona 85082-1312 USA
Phone: 480-829-7710 or 800-344-3860 Toll Free USA/Canada
Fax: 480-829-7709 or 800-344-3867 Toll Free USA/Canada
Email: orderlit@onsemi.com

N. American Technical Support: 800-282-9855 Toll Free
USA/Canada

Japan: ON Semiconductor, Japan Customer Focus Center
2-9-1 Kamimeguro, Meguro-ku, Tokyo, Japan 153-0051
Phone: 81-3-5773-3850

ON Semiconductor Website: <http://onsemi.com>

Order Literature: <http://www.onsemi.com/litorder>

For additional information, please contact your local Sales Representative.