



20CTQ150
20CTQ150S
20CTQ150-1

SCHOTTKY RECTIFIER

20 Amp





Major Ratings and Characteristics

Characteristics	Values	Units
$I_{F(AV)}$ Rectangular waveform	20	A
V_{RRM}	150	V
I_{FSM} @ $t_p = 5 \mu s$ sine	1030	A
V_F @ 10 Apk, $T_J = 125^\circ C$ (per leg)	0.66	V
T_J range	-55 to 175	$^\circ C$

Description/ Features

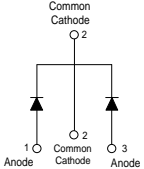
This center tap Schottky ectifier has been optimized for low reverse leakage at high temperature. The proprietary barrier technology allows for reliable operation up to 175° C junction temperature. Typical applications are in switching power supplies, converters, free-wheeling diodes, and reverse battery protection.

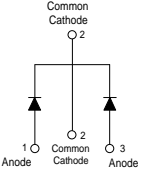
- 175° C T_J operation
- Center tap configuration
- Low forward voltage drop
- High purity, high temperature epoxy encapsulation for enhanced mechanical strength and moisture resistance
- High frequency operation
- Guard ring for enhanced ruggedness and long term reliability

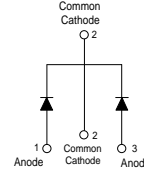
Case Styles		
<p>20CTQ150</p>  <p>Base Common Cathode O 2</p>  <p>1 O Anode O 2 Common Cathode O 3 Anode</p> <p>TO-220AB</p>	<p>20CTQ150S</p>  <p>Base Common Cathode O 2</p>  <p>1 O Anode O 2 Common Cathode O 3 Anode</p> <p>D²PAK</p>	<p>20CTQ150-1</p>  <p>Base Common Cathode O 2</p>  <p>1 O Anode O 2 Common Cathode O 3 Anode</p> <p>TO-262</p>

Voltage Ratings

Parameters	20CTQ150 20CTQ150S 20CTQ150-1
V_R Max. DC Reverse Voltage (V)	150
V_{RWM} Max. Working Peak Reverse Voltage (V)	

Absolute Maximum Ratings

Parameters	Values	Units	Conditions
$I_{F(AV)}$ Max. Average Forward Current (Per Leg) * See Fig. 5 (Per Device)	10	A	50% duty cycle @ $T_C = 154^\circ\text{C}$, rectangular wave form
	20		
I_{FSM} Max. Peak One Cycle Non-Repetitive Surge Current (Per Leg) * See Fig. 7	1030	A	5 μs Sine or 3 μs Rect. pulse 10ms Sine or 6ms Rect. pulse
	180		
E_{AS} Non-Repetitive Avalanche Energy (Per Leg)	2.45	mJ	$T_J = 25^\circ\text{C}$, $I_{AS} = 0.7$ Amps, $L = 10$ mH
I_{AR} Repetitive Avalanche Current (Per Leg)	0.7	A	Current decaying linearly to zero in 1 μsec Frequency limited by T_J max. $V_A = 1.5 \times V_R$ typical

Electrical Specifications

Parameters	Typ.	Max.	Units	Conditions
V_{FM} Max. Forward Voltage Drop (Per Leg) * See Fig. 1	0.80	0.88	V	@ 10A
	0.90	1.0	V	@ 20A
	0.63	0.66	V	@ 10A
	0.73	0.77	V	@ 20A
I_{RM} Max. Reverse Leakage Current (Per Leg) * See Fig. 2	3.0	25	μA	$T_J = 25^\circ\text{C}$
	2.7	5.0	mA	$T_J = 125^\circ\text{C}$
C_T Typical Junction Capacitance (Per Leg)	-	280	pF	$V_R = 5V_{DC}$ (test signal range 100kHz to 1Mhz) @ 25°C
L_S Typical Series Inductance (Per Leg)	-	8.0	nH	Measured lead to lead 5mm from package body
dv/dt Max. Voltage Rate of Change	-	10000	V/ μs	(Rated V_R)

(1) Pulse Width < 300 μs , Duty Cycle < 2%

Thermal-Mechanical Specifications

Parameters	Values	Units	Conditions
T_J Max. Junction Temperature Range	-55 to 175	$^\circ\text{C}$	
T_{stg} Max. Storage Temperature Range	-55 to 175	$^\circ\text{C}$	
R_{thJC} Max. Thermal Resistance Junction to Case (Per Leg)	2.0	$^\circ\text{C}/\text{W}$	DC operation
R_{thJC} Max. Thermal Resistance Junction to Case (Per Package)	1.0	$^\circ\text{C}/\text{W}$	DC operation
R_{thCS} Typical Thermal Resistance, Case to Heatsink	0.50	$^\circ\text{C}/\text{W}$	Mounting surface, smooth and greased (only for TO-220)
wt Approximate Weight	2 (0.07)	g (oz.)	
T Mounting Torque	Min.	6 (5)	Kg-cm (lbf-in)
	Max.	12 (10)	
Marking Device	20CTQ150	Case style TO-220	
	20CTQ150S	Case style D ² -Pak	
	20CTQ150-1	Case style TO-262	

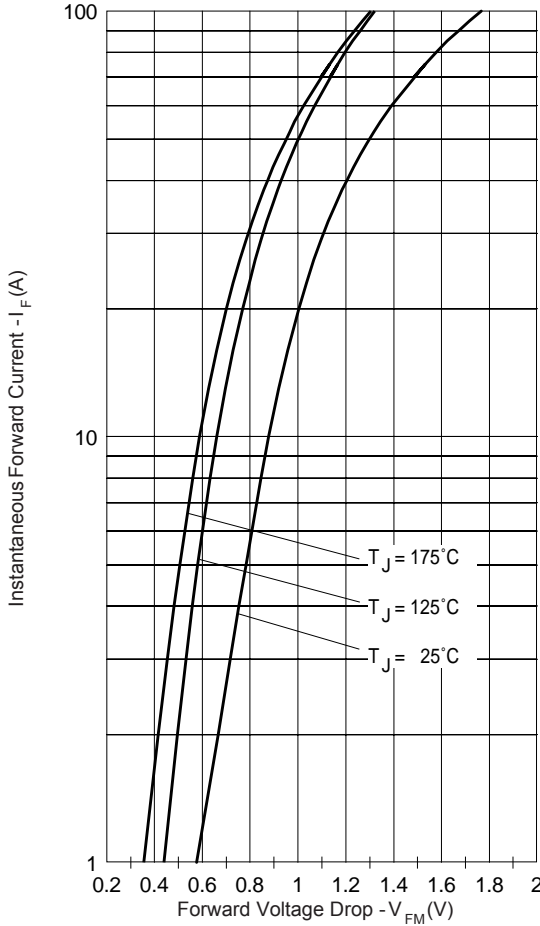

Fig. 1 - Max. Forward Voltage Drop Characteristics (Per Leg)

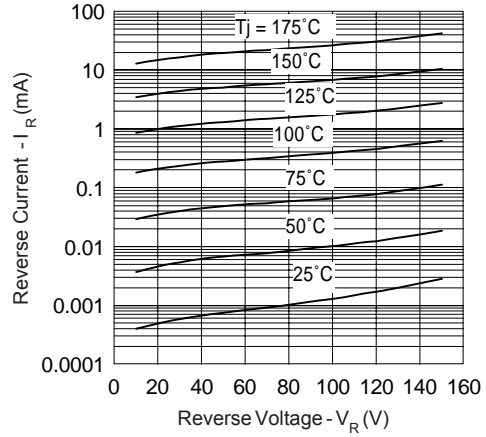

Fig. 2 - Typical Values Of Reverse Current Vs. Reverse Voltage (Per Leg)

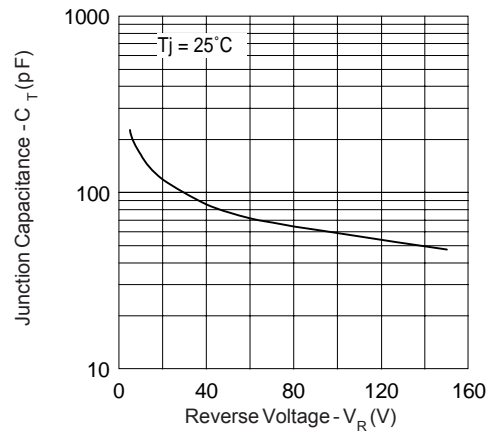

Fig. 3 - Typical Junction Capacitance Vs. Reverse Voltage (Per Leg)

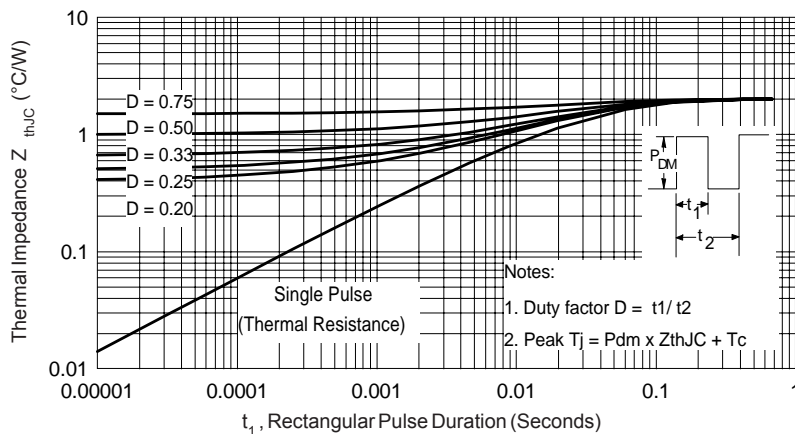

Fig. 4 - Max. Thermal Impedance Z_{thJC} Characteristics (Per Leg)

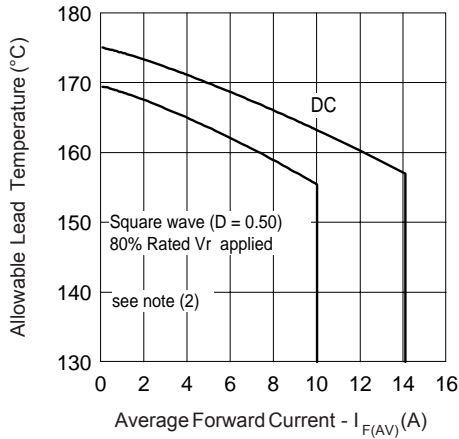

Fig. 5 - Maximum Average Forward Current Vs. Allowable Lead Temperature

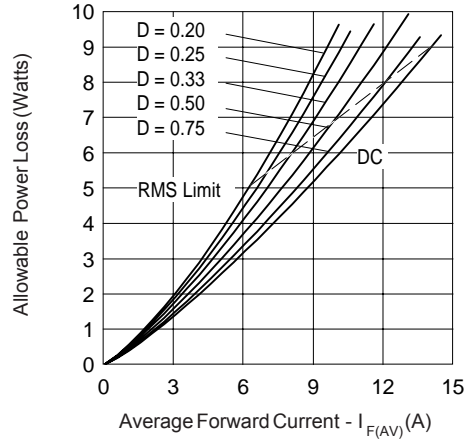

Fig. 6 - Maximum Average Forward Dissipation Vs. Average Forward Current

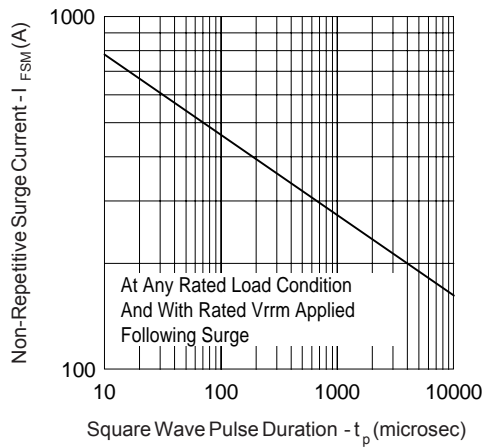

Fig. 7 - Maximum Peak Surge Forward Current Vs. Pulse Duration

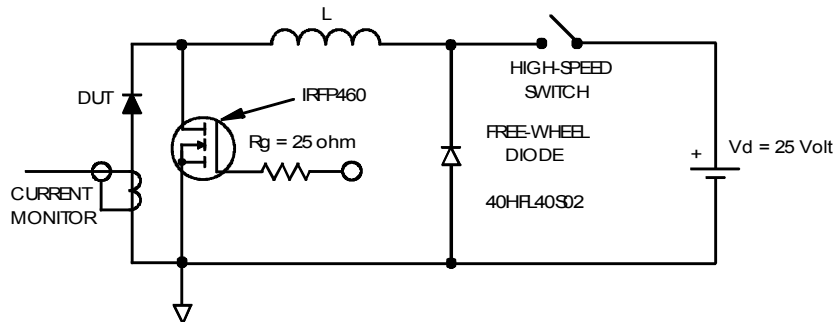
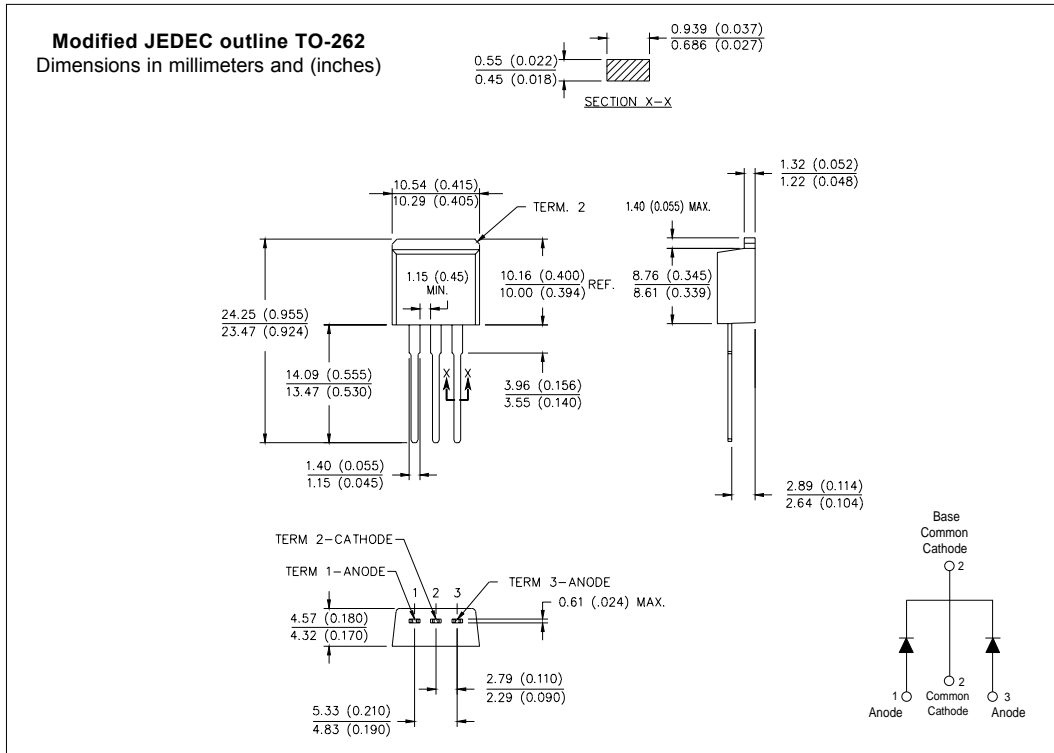
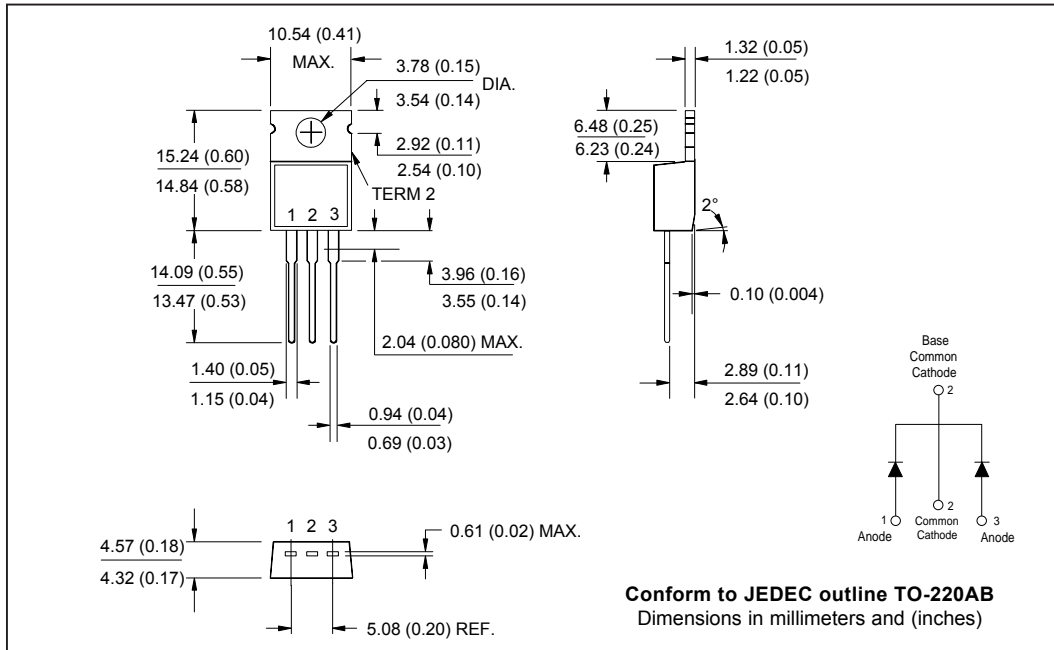

Fig. 8 - Unclamped Inductive Test Circuit

- (2) Formula used: $T_c = T_j - (Pd + Pd_{REV}) \times R_{thJC}$;
 $Pd = \text{Forward Power Loss} = I_{F(AV)} \times V_{FM} @ (I_{F(AV)} / D)$ (see Fig. 6);
 $Pd_{REV} = \text{Inverse Power Loss} = V_{R1} \times I_R (1 - D)$; $I_R @ V_{R1} = 80\% \text{ rated } V_R$

Outline Table



Outline Table

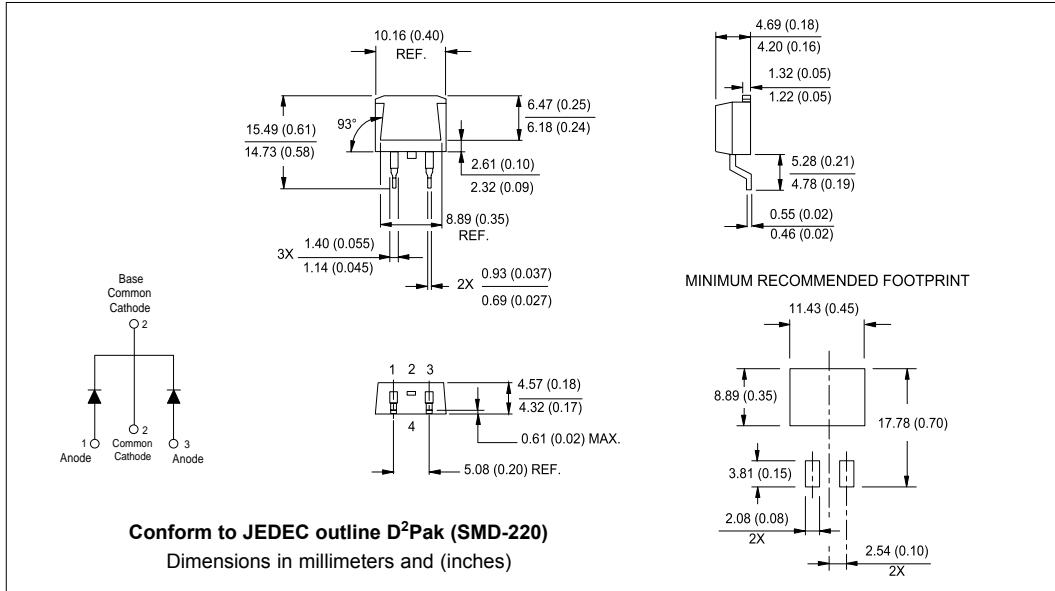

Tape & Reel Information

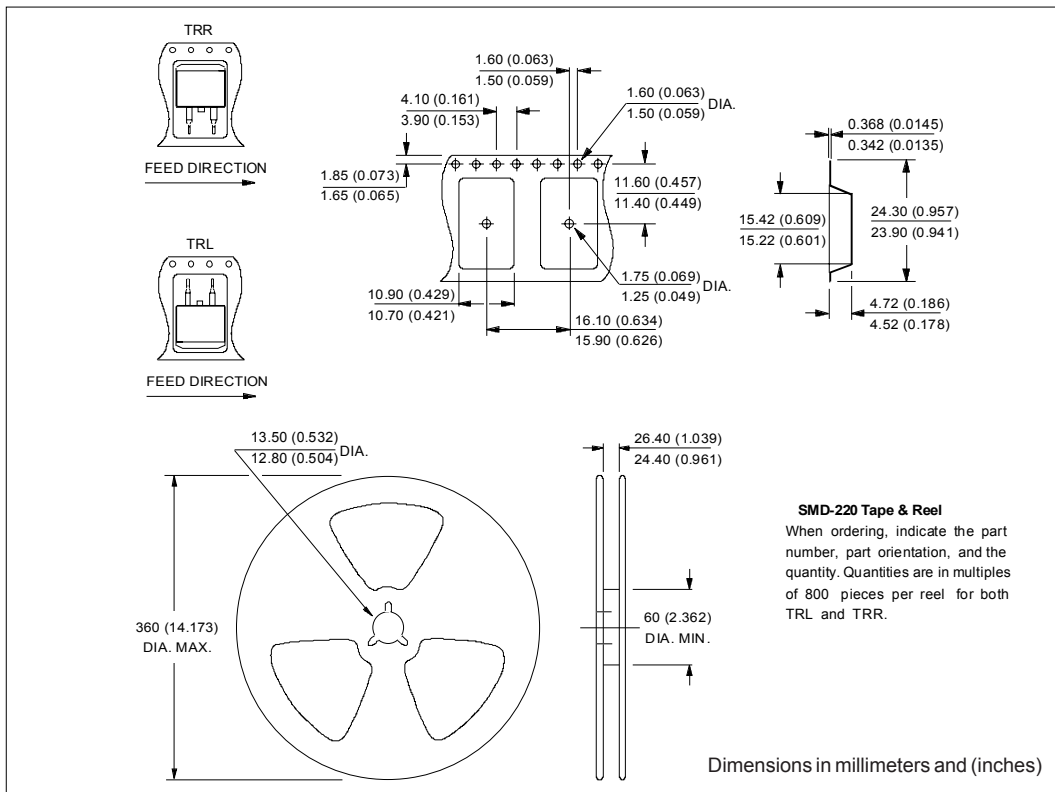

Part Marking Information

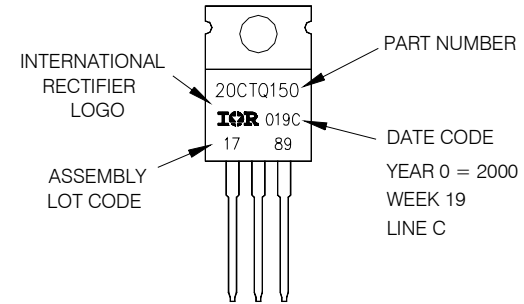
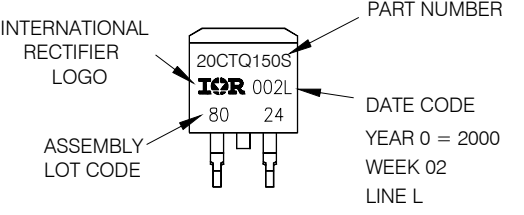
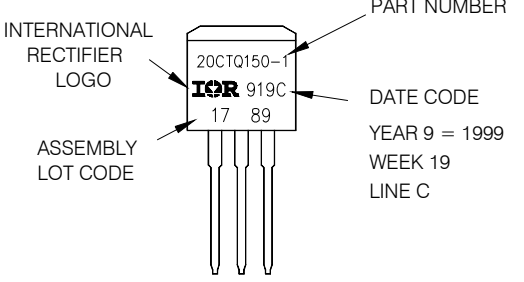
<p>EXAMPLE: THIS IS A 20CTQ150 LOT CODE 1789 ASSEMBLED ON WW 19, 2000 IN THE ASSEMBLY LINE "C"</p>	 <p>INTERNATIONAL RECTIFIER LOGO</p> <p>20CTQ150</p> <p>IR 019C</p> <p>17 89</p> <p>ASSEMBLY LOT CODE</p> <p>PART NUMBER</p> <p>DATE CODE YEAR 0 = 2000 WEEK 19 LINE C</p>
<p>TO-220</p>	
<p>EXAMPLE: THIS IS A 20CTQ150S LOT CODE 8024 ASSEMBLED ON WW 02, 2000 IN THE ASSEMBLY LINE "L"</p>	 <p>INTERNATIONAL RECTIFIER LOGO</p> <p>20CTQ150S</p> <p>IR 002L</p> <p>80 24</p> <p>ASSEMBLY LOT CODE</p> <p>PART NUMBER</p> <p>DATE CODE YEAR 0 = 2000 WEEK 02 LINE L</p>
<p>D²PAK</p>	
<p>EXAMPLE: THIS IS A 20CTQ150-1 LOT CODE 1789 ASSEMBLED ON WW 19, 1999 IN THE ASSEMBLY LINE "C"</p>	 <p>INTERNATIONAL RECTIFIER LOGO</p> <p>20CTQ150-1</p> <p>IR 919C</p> <p>17 89</p> <p>ASSEMBLY LOT CODE</p> <p>PART NUMBER</p> <p>DATE CODE YEAR 9 = 1999 WEEK 19 LINE C</p>
<p>TO-262</p>	

Ordering Information Table

Device Code									
	<table border="1" style="margin: auto;"> <tr> <td style="padding: 5px;">20</td> <td style="padding: 5px;">C</td> <td style="padding: 5px;">T</td> <td style="padding: 5px;">Q</td> <td style="padding: 5px;">150</td> <td style="padding: 5px;">S</td> <td style="padding: 5px;">TRL</td> <td style="padding: 5px;">-</td> </tr> </table>	20	C	T	Q	150	S	TRL	-
20	C	T	Q	150	S	TRL	-		
	<table style="margin: auto;"> <tr> <td style="text-align: center;">①</td> <td style="text-align: center;">②</td> <td style="text-align: center;">③</td> <td style="text-align: center;">④</td> <td style="text-align: center;">⑤</td> <td style="text-align: center;">⑥</td> <td style="text-align: center;">⑦</td> <td style="text-align: center;">⑧</td> </tr> </table>	①	②	③	④	⑤	⑥	⑦	⑧
①	②	③	④	⑤	⑥	⑦	⑧		
1	- Current Rating (20 = 20A)								
2	- C = Common Cathode								
3	- T = TO-220								
4	- Q = Schottky Q Series								
5	- Voltage Rating (150 = 150V)								
6	- <ul style="list-style-type: none"> • none = TO-220AB • -1 = TO-262 • S = D²Pak 								
7	- <ul style="list-style-type: none"> • none = Tube (50 pieces) • TRL = Tape & Reel (Left Oriented - for D²Pak only) • TRR = Tape & Reel (Right Oriented - for D²Pak only) 								
8	- <ul style="list-style-type: none"> • none = Standard Production • PbF = Lead-Free 								

Data and specifications subject to change without notice.
 This product has been designed for Industrial Level.
 Qualification Standards can be found on IR's Web site.