

# Reversible motor driver

## BA6289F / BA6417F

The BA6289F and BA6417F are reversible-motor drivers, with an output current of 600mA for the former and 1A for the latter. Two logic inputs allow four output modes: forward, reverse, stop (idling), and brake. A built-in power saving circuit suppresses current consumption when the motor is in stop mode.

### ●Applications

Compact, low-current DC motors and portable equipment such as camcorders

### ●Features

- 1) Two logic inputs allow four output modes: forward, reverse, stop (idling), and brake.
- 2) Built-in power saving circuit suppresses the stop mode current dissipation.
- 3) Output voltage can be set arbitrarily with the  $V_{ref}$  pin.
- 4) Interfaces with TTL devices.
- 5) Built-in thermal shutdown circuit turns off all circuits when high IC junction temperature is detected.

### ●Absolute maximum ratings ( $T_a = 25^\circ\text{C}$ )

Parameter		Symbol	Limits	Unit
Applied voltage		$V_{CC}$	18	V
Power dissipation		$P_d$	650*1	mW
Operating temperature		$T_{opr}$	$-20 \sim +75$	$^\circ\text{C}$
Storage temperature		$T_{stg}$	$-55 \sim +150$	$^\circ\text{C}$
Output current	BA6289F	$I_{out}$	600*2	mA
	BA6417F		1000*3	

\*1 When mounted on a glass epoxy board ( $50 \times 50 \times 1.6$  mm).  
Reduced by 5.2 mW for each increase in  $T_a$  of  $1^\circ\text{C}$  over  $25^\circ\text{C}$ .

\*2, \*3 Should not exceed  $P_d$  or ASO values.

### ●Recommended operating conditions

Parameter	Symbol	Range	Unit
Operating power supply voltage	$V_{CC}$	3.5~15	V
	$V_M$	0~15	V
$V_{ref}$ pin input voltage	$V_{ref}$	0~ ( $V_{CC}-1V$ )	V

●Block diagram

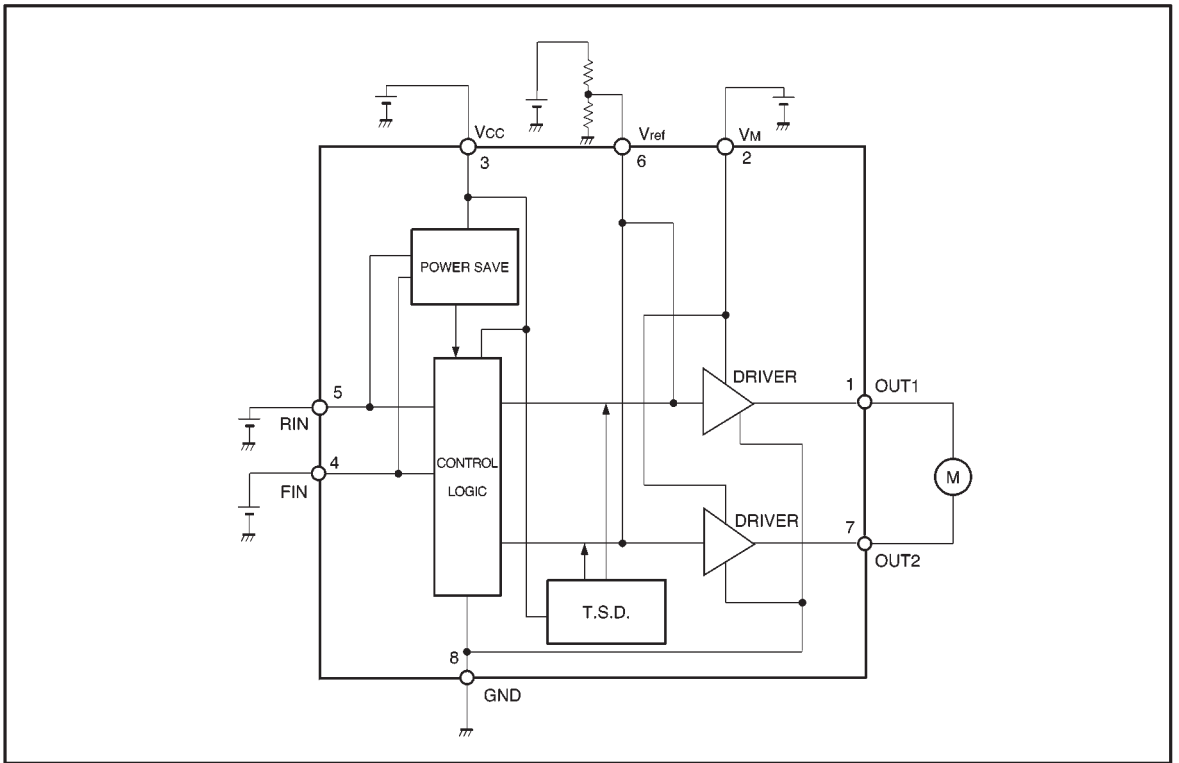

●Pin descriptions

Pin No.	Pin name	Function
1	OUT1	Motor output
2	VM	Motor power supply
3	VCC	Power supply
4	FIN	Logic input
5	RIN	Logic input
6	Vref	HIGH level output voltage setting
7	OUT2	Motor output
8	GND	Ground

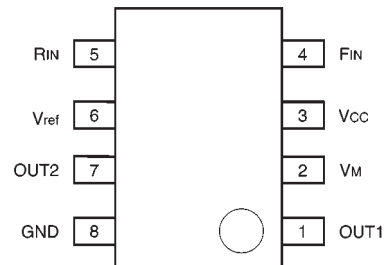

Fig.1 Pin assignments

● Electrical characteristics of BA6289F (unless otherwise noted,  $T_a = 25^\circ\text{C}$ ,  $V_{CC} = 6\text{V}$ ,  $V_M = 6\text{V}$ )

Parameter	Symbol	Min.	Typ.	Max.	Unit	Conditions
Supply current 1	$I_{CC1}$	19	32	45	mA	Forward or reverse mode $I_O = 200\text{mA}$ , $V_{ref} = 4\text{V}$
Supply current 2	$I_{CC2}$	22	36	50	mA	Brake mode, $V_{ref} = 4\text{V}$
Standby Supply current	$I_{ST}$	—	—	15	$\mu\text{A}$	Standby mode, $V_{ref} = 4\text{V}$
Input high level voltage	$V_{IH}$	2.0	—	—	V	
Input low level voltage	$V_{IL}$	—	—	0.8	V	
Input high level current	$I_{IH}$	45	90	135	$\mu\text{A}$	$V_{IN} = 2.0\text{V}$
Output saturation voltage	$V_{CE}$	—	1.0	1.5	V	$I_O = 200\text{mA}$ , $V_{ref} = 6\text{V}$ Sum of output transistor high- and low-side voltages
$V_{ref}$ -pin source current	$I_{ref}$	—	0.40	2.0	$\mu\text{A}$	Forward or reverse mode $V_{ref} = 2.5\text{V}$
$V_{OUT} - V_{ref}$ offset	$V_{OUT}$ OFF	$V_{ref}$ -130	$V_{ref}$ -50	$V_{ref}$ +20	mV	$V_{ref} = 2.5\text{V}$ $I_O = 100\text{mA}$
Output transistor current capacity 1	$I_{OMax.1}$	500	—	—	mA	$V_{CC} = 3.5\text{V}$ Low-side transistor, $V_{CE} = 1.0\text{V}$ $V_{ref} = 2.0\text{V}$
Output transistor current capacity 2	$I_{OMax.2}$	600	—	—	mA	$V_{CC} = 4.0\text{V}$ Low-side transistor, $V_{CE} = 1.0\text{V}$ $V_{ref} = 2.5\text{V}$

© Not designed for radiation resistance.

● Electrical characteristics of BA6417F (unless otherwise noted, Ta = 25°C, V<sub>CC</sub> = 6V, V<sub>M</sub> = 6V)

Parameter	Symbol	Min.	Typ.	Max.	Unit	Conditions
Supply current 1	I <sub>CC1</sub>	24	39	56	mA	Forward or reverse mode I <sub>O</sub> =200mA, V <sub>ref</sub> =V <sub>CC</sub>
Supply current 2	I <sub>CC2</sub>	30	48	67	mA	Brake mode, V <sub>ref</sub> =V <sub>CC</sub>
Standby Supply current	I <sub>ST</sub>	—	—	15	μA	Standby mode, V <sub>ref</sub> =V <sub>CC</sub>
Input high level voltage	V <sub>IH</sub>	2.0	—	—	V	
Input low level voltage	V <sub>IL</sub>	—	—	0.8	V	
Input high level current	I <sub>IH</sub>	45	90	135	μA	V <sub>IN</sub> =2.0V
Output saturation voltage	V <sub>CE</sub>	—	1.0	1.5	V	I <sub>O</sub> =200mA, V <sub>ref</sub> =V <sub>CC</sub> Sum of output transistor high- and low-side voltages
V <sub>ref</sub> -pin source current	I <sub>ref</sub>	—	1.3	3.5	μA	Forward or reverse mode V <sub>ref</sub> =2.5V
V <sub>OUT</sub> - V <sub>ref</sub> offset	V <sub>OUT</sub> OFF	V <sub>ref</sub> +0	V <sub>ref</sub> +100	V <sub>ref</sub> +200	mV	V <sub>ref</sub> =2.5V I <sub>O</sub> =100mA
Output transistor current capacity 1	I <sub>O</sub> Max.1	900	—	—	mA	V <sub>CC</sub> =3.5V Low-side transistor, V <sub>CE</sub> =1.0V V <sub>ref</sub> =V <sub>CC</sub>
Output transistor current capacity 2	I <sub>O</sub> Max.2	1000	—	—	mA	V <sub>CC</sub> =4.0V Low-side transistor, V <sub>CE</sub> =1.0V V <sub>ref</sub> =V <sub>CC</sub>
V <sub>M</sub> leakage current	I <sub>LM</sub>	—	—	5	μA	All pins except V <sub>M</sub> and GND are OPEN

⊙ Not designed for radiation resistance.

● Input / output truth table

FIN	RIN	OUT2	OUT1	Mode
H	L	L	H	Forward
L	H	H	L	Reverse
H	H	L	L	Brake
L	L	OPEN	OPEN	Standby

## ● Input / output circuits

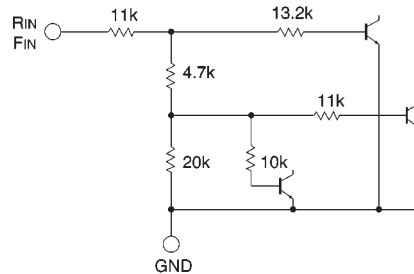
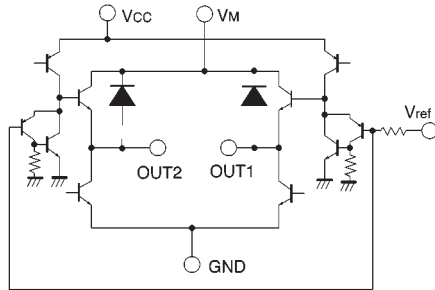

Resistances are typical values

Fig.2

## ● Operation notes

(1) The quality of these products have been carefully checked; however, use of the products with applied voltages, operating temperatures, or other parameters that exceed the absolute maximum rating given may result in the damage of the IC and the product it is used in. If the IC is damaged, the short mode and open modes cannot be specified, so if the IC is to be used in applications where parameters may exceed the absolute maximum ratings, then be sure to incorporate fuses, or other physical safety measures.

## (2) GND potential

The potential for pin 8 must be kept lower than the potentials of the other pins regardless of the circumstances.

## (3) Input pins

Voltage should never be applied to the input pins when the  $V_{CC}$  voltage is not applied to the IC. Similarly, when  $V_{CC}$  is applied, the voltage on each input pin should be less than  $V_{CC}$  and within the guaranteed range for the electrical characteristics.

## (4) Back-rush voltage

Depending on the ambient conditions, environment, or motor characteristics, the back-rush voltage may fluctuate. Be sure to confirm that the back-rush voltage will not adversely affect the operation of the IC.

## (5) Large current line

Large currents are carried by the motor power supply and motor ground for these ICs.

Therefore, the layout of the pattern of the PC board and the constants of certain parameters for external components, such as the capacitor between the power supply and ground, may cause this large output current to flow back to the input pins, resulting in output oscillation or other malfunctions. To prevent this, make sure that the PC board layout and external circuit constants cause no problems with the characteristics of these ICs.

## (6) Power dissipation

The power dissipation will fluctuate depending on the mounting conditions of the IC and the ambient environment. Make sure to carefully check the thermal design of the application where these ICs will be used.

## (7) Power consumption

The power consumption by the IC varies widely with the power supply voltage and the output current. Give full consideration to the power dissipation rating and the thermal resistance data and transient thermal resistance data, to provide a thermal design so that none of the ratings for the IC are exceeded.

## (8) ASO

Make sure that the output current and supply voltage do not exceed the ASO values.

## (9) Precautions for input mode switching

To ensure reliability, it is recommended that the mode switching for the motor pass once through the open mode.

(10) In-rush current

There are no circuits built into these ICs that prevent in-rush currents. Therefore, it is recommended to place a current limiting resistor or other physical countermeasure.

(11) Factors regarding the thermal, power supply, and motor conditions

If the potential of the output pin sways greatly and goes below the potential of ground, the operation of the IC may malfunction or be adversely affected. In such a case, place a diode between the output and ground, or other measure, to prevent this.

(12) HIGH level output voltage setting pin

The output voltage can be varied by controlling the  $V_{ref}$  voltage :

$$V_{OH} = V_{ref} + V_{BE} \text{ (PNP)} - V_{BE} \text{ (NPN)} + (V_{OUT} - V_{ref} \text{ offset})$$

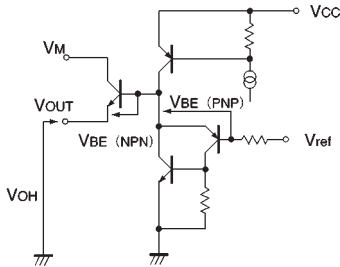

Fig.3

The voltage applied to the  $V_{ref}$  pin should not exceed the motor supply voltage (pin 2) or the  $V_{CC}$  voltage. The  $V_{ref}$  input range over which the HIGH level output voltage can be controlled according to the above equation is between 0V and  $(V_{CC} - V_{SAT} - V_{BE})$ .

The output may oscillate if the  $V_{ref}$  voltage is controlled by a low-impedance circuit. Set the voltage by either providing an impedance of about 10kΩ or connecting a capacitor between the  $V_{ref}$  and GND pins. Because the optimum impedance and capacitance values depend on such factors as the type of motor, the PCB pattern, and the load current, the values must be determined separately for each application.

(13) Thermal shutdown circuit

When the thermal shutdown circuit is activated at the IC junction temperature of about 175°C (typical), all driver outputs are turned OFF. There is a temperature difference of about 15°C (typical) between the temperatures at which the circuit is activated and deactivated.

(13) The input pins (pins 4 and 5 have temperature dependent characteristics. Take the temperature effect into consideration when using the IC.

(14) To eliminate motor noise, connect a capacitor between OUT1 (pin 1) and GND and between OUT2 (pin 7) and GND. Alternatively, connect a capacitor between OUT1 and OUT2, and also a diode between OUT1 and GND and between OUT2 and GND.

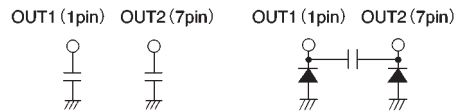

Fig.4

●Application example

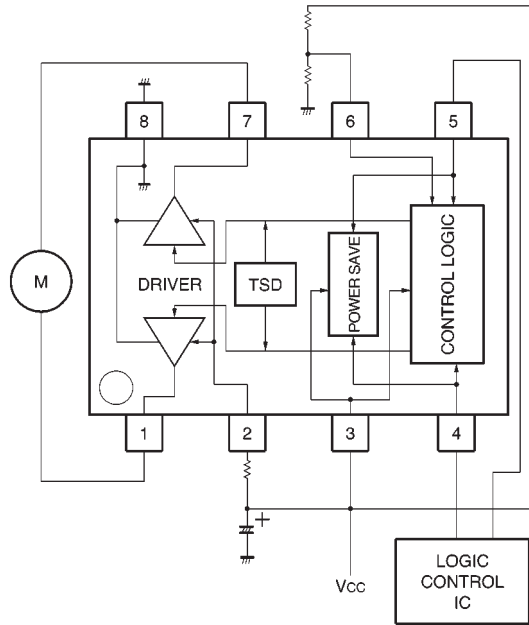

Fig.5

●Electrical characteristic curves

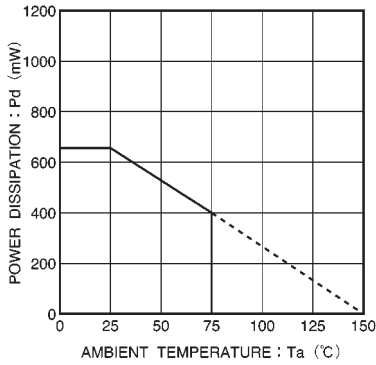

Fig.6 Power dissipation curve

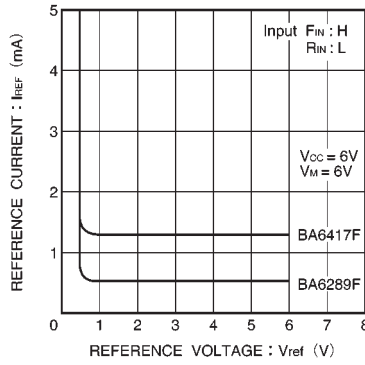

Fig.7  $V_{ref}$  reference current vs.  $V_{ref}$  reference voltage

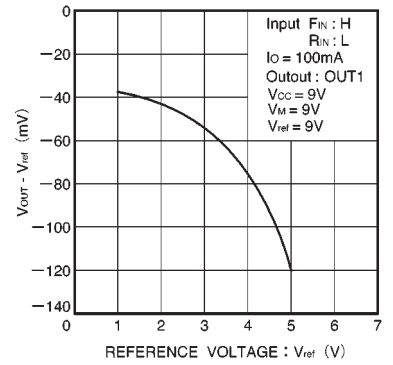

Fig.8  $V_{out}-V_{ref}$  voltage differential vs.  $V_{ref}$  reference voltage (BA6289F)

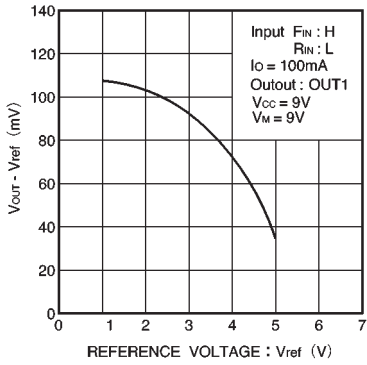

Fig.9  $V_{out}-V_{ref}$  voltage differential vs.  $V_{ref}$  reference voltage (BA6417F)

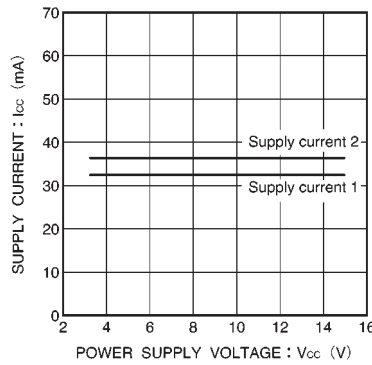

Fig.10 Supply current vs. power supply voltage (BA6289F)

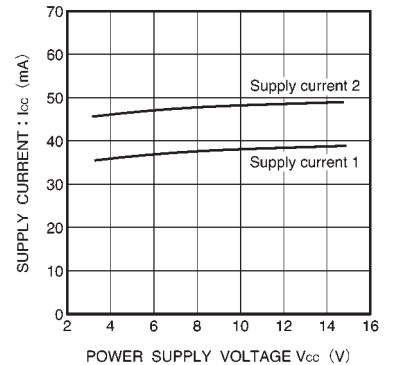

Fig.11 Supply current vs. power supply voltage (BA6417F)

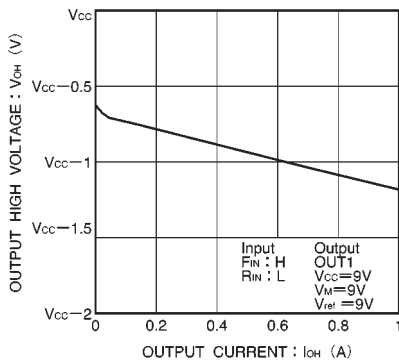

Fig.12 Output high level voltage vs. output current

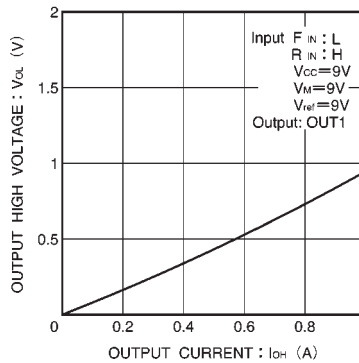

Fig.13 Output low level voltage vs. output current



● External dimensions (Units: mm)

