

比例 3:5

剖面 C-C

下盖正视图

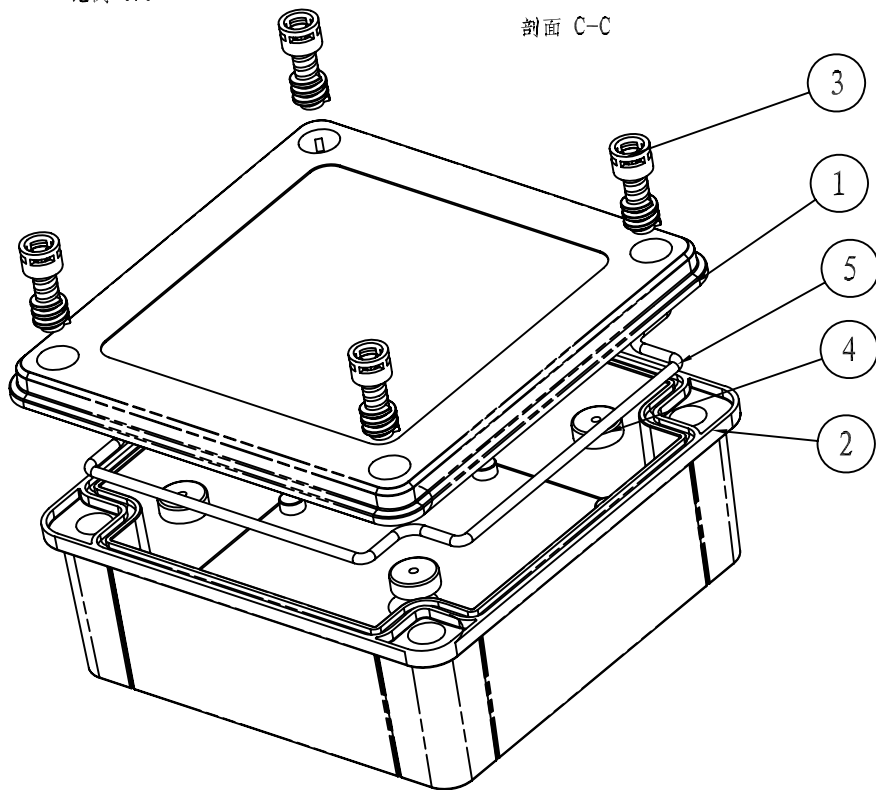

5	MPT3	3mm发泡密封条	1	发泡硅胶		
4	11-95-4	密封塞	4	聚氯乙烯	借用原有产品	
3	11-98-3	塑料螺钉	4	PC	借用原有产品	
2	11-108-2	下盖	1	普通ABS		
1	11-108-1	上盖	1	普通ABS		
<u>序号</u> Number	<u>产品编号</u> Product Code	<u>零件名称</u> Part Name	<u>数量</u> Quantity	<u>材料</u> Material	<u>重量(g)</u> Weight	<u>备注</u> Remarks
<u>制图</u> Drawing	<u>审核</u> Auditing	<u>批准</u> Confirm	<u>客户名称</u> Custom Name	<u>材料</u> Material		
			<u>产品名称</u> Product Name	装配图	<u>图纸比例</u> Drawing Scale	1:1 A
			<u>产品编号</u> Product Code	11-108	<u>视图</u> Project View	(mm)
共 1 页 第 1 页			宁波三和壳体公司 NINGBO SANHE ENCLOSURE CORPORATION		中国·宁波慈溪 TEL:+86(574)63226910 FAX:+86(574)63226900	